



Directional Drilling Guidance System

Operator's Manual

403-2300-00-D, printed on 8/11/2017

© 2017 Digital Control Incorporated. All rights reserved.

Trademarks

The Aurora logo, the DCI® logo, Aurora®, DigiTrak®, DigiTrak Falcon®, F2®, and *Target Steering*® are U.S. registered trademarks and *Ball-in-the-Box*™, F Series™, and SuperCell™ are common law trademarks of Digital Control Incorporated.

Patents

U.S. and foreign patents apply to the product covered by this manual. For details, please visit www.DigiTrak.com/patents.

Limited Warranty

All products manufactured and sold by Digital Control Incorporated (DCI) are subject to the terms of a Limited Warranty. A copy of the Limited Warranty is included at the end of this manual; it can also be obtained at www.DigiTrak.com.

Important Notice

All statements, technical information, and recommendations related to DCI products are based on information believed to be reliable. However, DCI does not warrant or guarantee the accuracy or completeness of such information. Before using any DCI product, the user should determine the suitability of the product for its intended use. All statements herein refer to DCI products as delivered by DCI for use with horizontal directional drilling in the ordinary course, and do not apply to any user customizations, third-party products, or any usage of the DCI product outside of the ordinary course. Nothing herein shall constitute a warranty by DCI nor will anything herein be deemed to modify the terms of DCI's existing Limited Warranty applicable to all DCI products. DCI may update or correct the information in this manual from time to time. You may find the most recent version of this manual on DCI's website, www.DigiTrak.com. Under **Service & Support**, click **Documentation** and select from the **Manuals** drop-down menu.

Compliance Statement

This equipment complies with Part 15 of the Rules of the FCC and with Industry Canada license-exempt RSS standards and with Australia Class License 2000 for LIPD (low interference potential devices). Operation is subject to the following two conditions: (1) this equipment may not cause harmful interference, and (2) this equipment must accept any interference received, including interference that may cause undesired operation. DCI is responsible for FCC compliance in the United States: Digital Control Incorporated, 19625 62nd Ave S, Suite B103, Kent WA 98032; phone 425.251.0559 or 800.288.3610 (US/CA).

Changes or modifications to any DCI equipment not expressly approved and carried out by DCI will void the user's Limited Warranty and the FCC's authorization to operate the equipment.

CE Requirements

DigiTrak receivers are classified as Class 2 radio equipment per the R&TTE Directive and may not be legal to operate or require a user license to operate in some countries. The list of restrictions and the required declarations of conformity are available on DCI's website at www.DigiTrak.com. Under **Service & Support**, click **Documentation** and select from the **CE Documents** drop-down menu.

Contact Us

United States
DCI Headquarters

19625 62nd Ave S, Suite B103
Kent, Washington 98032, USA
1.425.251.0559 / 1.800.288.3610
1.425.251.0702 fax
dci@digital-control.com

Australia

2/9 Frinton Street
Southport QLD 4215
61.7.5531.4283
61.7.5531.2617 fax
dci.australia@digital-control.com

China

368 Xingle Road
Huacao Town
Minhang District
Shanghai 201107, P.R.C.
86.21.6432.5186
86.21.6432.5187 传真
dci.china@digital-control.com

Europe

Brueckenstraße 2
97828 Marktheidenfeld
Deutschland
49.9391.810.6100
49.9391.810.6109 Fax
dci.europe@digital-control.com

India

DTJ 203, DLF Tower B
Jasola District Center
New Delhi 110025
91.11.4507.0444
91.11.4507.0440 fax
dci.india@digital-control.com

Russia

Молодогвардейская ул., д.4
стр. 1, офис 5
Москва, Российская Федерация 121467
7.499.281.8177
7.499.281.8166 факс
dci.russia@digital-control.com

Dear Customer,

Thank you for choosing a DigiTrak guidance system. We are proud of the equipment we have been designing and building in Washington State since 1990. We believe in providing a unique, high-quality product and standing behind it with world-class customer service and training.

Please take the time to read this entire manual, especially the section on safety. Please also register your equipment online at access.DigiTrak.com. Or, fill in the product registration card provided with this equipment and either fax it to us at 253-395-2800 or mail it to DCI headquarters.

Product registration entitles you to free telephone support (in the USA and Canada), notification of product updates, and helps us provide you with future product upgrade information.

Our Customer Service department is available 24 hours a day, 7 days a week in the U.S. to help with problems or questions. International contact information is available in this document and on our website.

As the horizontal directional drilling industry grows, we're keeping our eye on the future to develop equipment that makes your job faster, easier, and safer. Visit us online any time to see what we're up to.

We welcome your questions, comments, and ideas.

Digital Control Incorporated
Kent, Washington
2017

Watch our DigiTrak Training Videos at www.youtube.com/dcikent

For system component name and model information, refer to [Appendix A](#) on page 62.

Table of Contents

Important Safety Instructions	1
General	1
Pre-Drilling Testing	2
Interference	2
Potential Interference Received	2
Potential Interference Generated	2
Battery Pack Storage	3
Equipment Maintenance	3
General Transmitter Care Instructions	3
Getting Started	5
Introduction	5
Using This Manual	6
Powering On	6
Receiver	7
Transmitter	7
Remote Display (FCD)	7
Setup Summary	7
Select Frequency Optimizer	7
Assign Frequency Bands	8
Interference Check	8
Calibrate	8
Above Ground Range Check	8
Drill	8
Receiver	9
Overview	9
Trigger Switch	9
Audible Tones	10
Startup Screen	10
Adjusting Screen Contrast	11
Your Remote Display	11
Receiver Menus	12
Frequency Optimizer	13
So I Just Paired, Now What?	17
Power Off	17
Height-Above-Ground (HAG)	17
Turn HAG On	18
Turn HAG Off	18
Set HAG Value	19
Calibration and AGR	19
1-Point Calibration	20
Above Ground Range (AGR)	22
50 Foot Calibration (Optional)	23
Settings	23
Depth Units Menu	23

Pitch Units Menu	24
Roll Offset Menu	24
Transmitter Options Menu	25
System Timer Menu	27
Telemetry Channel Menu	27
Bubble Level	27
Signal Strength Values	28
Target Steering	28
Locating Basics	29
Locating Screens	30
Locate Screen	30
Locate Screen Shortcuts	31
Depth Screen	31
Predicted Depth Screen	32
Depth Screen, Invalid Location	33
Interference	33
What is Interference?	34
Checking for Interference	34
Roll/Pitch Check	35
Suggestions for Dealing with Interference	36
Locate Points (FLP & RLP) and Locate Line (LL)	37
Effects of Depth, Pitch, and Topography on Distance Between FLP and RLP	38
Marking Locate Points	39
Locating the Transmitter	39
Finding the Front Locate Point (FLP)	40
Finding the Locate Line (LL)	41
Finding the RLP to Confirm Transmitter Heading and Position	43
Advanced Locating	45
Tracking “On-the-Fly”	45
Off-Track Locating	46
Target Steering	48
Feasible Target Steering Area	49
Turning Target Steering On and Off	50
Setting the Target Depth	51
Positioning the Receiver as the Target	52
Steering to the Target with the Remote Display	53
Target Steering in Interference Areas	53
Transmitter	54
Batteries and Power On/Off	55
15-inch Transmitters	55
8-inch Transmitters	55
Installing Batteries / Power On (15-inch)	55
Transmitter Battery Strength	56
Transmitter Current Draw Warning	56
Sleep Mode	57
Transmitter Drill Head Requirements	57
Temperature Status and Overheat Indicator	58
Transmitter Temperature Warning Tones	58
Transmitter Overheat Indicator (Temp Dot)	59

Transmitter Warranty Timer	59
Changing Frequency Bands	59
Above Ground (Pre-Bore) Tilt Method	60
Below Ground (Mid-Bore) Roll Methods	60
Appendix A: System Specifications	62
Power Requirements	62
Environmental Requirements	62
Storage and Shipping Requirements	62
Temperature	62
Packaging	62
Equipment and Battery Disposal	63
Transmitter Pitch Resolution	63
Appendix B: Receiver Screen Symbols	64
Appendix C: Projected Depth Versus Actual Depth and the Fore/Aft Offset	66
Appendix D: Calculating Depth Based on Distance Between FLP and RLP	70
Appendix E: Reference Tables	71
Depth Increase in Inches per 10-foot Rod	71
Depth Increase in Inches per 15-foot Rod	72

WARRANTY

Important Safety Instructions

General

The following warnings relate generally to the operation of DigiTrak[®] guidance systems. This is not an exhaustive list. Always operate your DigiTrak guidance system in accordance with the manual and be aware of interference that may affect efforts to retrieve accurate data with this guidance system. Failure to do so can be hazardous. If you have any questions about the operation of the system, please contact DCI Customer Service for assistance.



To prevent potentially dangerous conditions, all operators must read and understand the safety precautions, warnings, and instructions before using a DigiTrak guidance system.



DigiTrak guidance systems cannot be used to locate utilities.

Failure to use the front and rear locate points technique described in this manual for locating the transmitter can lead to inaccurate locates.

Serious injury and death as well as substantial property damage can result if underground drilling equipment makes contact with an underground utility, including natural gas lines, high-voltage electrical cable, or other utilities.



DCI equipment is not explosion-proof and should never be used near flammable or explosive substances.



Work slowdowns and cost overruns can occur if drilling operators do not use the drilling or guidance equipment correctly to obtain proper performance.

Directional drilling operators MUST at all times:

- Understand the safe and proper operation of drilling and guidance equipment, including proper grounding procedures and techniques for identifying and mitigating interference.
- Ensure all underground utilities and all potential sources of interference have been located, exposed, and accurately marked prior to drilling.
- Wear protective safety clothing such as dielectric boots, gloves, hard hats, high-visibility vests, and safety glasses.
- Locate and track the transmitter in the drill head accurately and correctly during drilling.
- Maintain a minimum distance of 8 in. from the front of the receiver to the user's torso to ensure compliance with RF exposure requirements.
- Comply with federal, state, and local governmental regulations (such as OSHA).
- Follow all other safety procedures.

Remove the batteries from all system components during shipping and prolonged storage. Failure to do so may result in battery leakage, which may lead to risk of explosion, health risks, and/or damage.

Store and transport batteries using a suitable protective case that will keep batteries safely isolated from one another. Failure to do so may result in short circuits, which may lead to hazardous conditions including fire. See [Appendix A](#) for important restrictions on shipping lithium-ion batteries.

Use of this equipment is restricted to internal use at a construction site.

Pre-Drilling Testing

Before each drilling run, test your DigiTrak guidance system with the transmitter inside the drill head to confirm it is operating properly and providing accurate drill head location and heading information.

During drilling, the depth will not be accurate unless:

- The receiver has been properly calibrated and the calibration has been checked for accuracy so the receiver shows the correct depth.
- The transmitter has been located correctly and accurately and the receiver is directly above the transmitter in the drill head underground or at the front locate point.
- The receiver is placed on the ground or held at the correct height-above-ground distance, which has been set correctly.

Always test calibration after you have stopped drilling for any length of time.

Interference

The Falcon frequency optimizer selects frequencies based on measured active interference at a given point in time and space. Active interference levels can change with time and location, passive interference (which the system does not detect) may be present, and performance may vary as a result. Selections by the frequency optimizer are not a substitute for prudent operator judgment. If performance drops while drilling, consider switching to the other selected band or using Max Mode.

Potential Interference Received

Interference can cause inaccuracies in the measurement of depth and loss of the transmitter's pitch, roll, or heading. Always perform a background noise check using your receiver (locator), as well as a visual inspection for possible sources of interference, prior to drilling.

A background noise check will not identify all sources of interference, as it can only pick up sources that are active, not passive. Interference, as well as a partial list of sources of interference, are discussed in the section [Interference](#) on page 33.

Never rely on data that does not display quickly and/or remain stable.

If an **A** displays at the bottom left of the roll indicator or frequency optimizer at distances greater than 10 ft. from the transmitter, [attenuation](#) is in effect, indicating the presence of excessive noise that can lead to inaccurate depth readings. A flashing signal strength indicates the presence of extreme interference; depth and locate points will not be accurate.

Potential Interference Generated

Because this equipment may generate, use, and radiate radio frequency energy, there is no guarantee that interference will not occur at a particular location. If this equipment does interfere with radio or television reception, which can be determined by powering the equipment off and on, try to correct the interference using one or more of the following measures:

- Reorient or relocate the receiving antenna.
- Increase the separation between the receiver and affected equipment.
- Consult the dealer, DCI, or an experienced radio/TV technician for help.
- Connect the equipment to an outlet on a different circuit.

Battery Pack Storage

If you plan to store the battery packs for any period of time, please follow these guidelines:

- Do not store the battery pack at temperatures greater than 113° F.
- Do not store the battery pack in a fully discharged state.
- Do not store the battery pack in the battery charger.
- Do not store multiple batteries together where their terminals or other loose conductive materials may contact one another and cause a short circuit.

If a lithium-ion battery pack will be stored for an extended period of time, pre-charge the battery to a charge level of 30% to 50% (two or three LEDs illuminated on the meter). Do not store the battery pack for more than one year unless it is periodically recharged to the 30% to 50% level.

Equipment Maintenance

Turn off all equipment when not in use.

Store the equipment in cases, away from extremes of heat, cold, and moisture. Test to confirm proper operation prior to use.

Clean the glass screens on the receiver and remote display only with a cleaner specifically formulated to not harm the protective coatings on the glass. If in doubt, use only warm water and a microfiber cloth. Do not use household or commercial window cleaning products that include chemicals such as ammonia, alcohol, or any acidic liquid; these cleaners can contain microscopic abrasive granules that will damage the anti-reflective coating and may cause the display to spot.

Clean equipment cases and housings using only a soft moist cloth and mild detergent.

Do not steam clean or pressure wash.

Inspect the equipment daily and contact DCI if you see any damage or problems. Do not disassemble or attempt to repair the equipment.

Do not store or ship this equipment with batteries inside. Always remove the batteries from the equipment before shipping or periods of non-use.

The battery charger provided with your DigiTrak guidance system is designed with adequate safeguards to protect you from shock and other hazards when used as specified within this document. If you use the battery charger in a manner not specified by this document, the protection provided may be impaired. Do not attempt to disassemble the battery charger, it contains no user-serviceable parts. The battery charger shall not be installed into caravans, recreational vehicles, or similar vehicles.

General Transmitter Care Instructions

Periodically clean the spring and threads inside the battery compartment as well as the spring and threads of the battery end cap to ensure a proper power connection with the batteries. Use an emery cloth or wire brush to remove any oxidation that has built up. Be careful not to damage the battery cap O-ring; remove it while cleaning if necessary. After cleaning, use a conductive lubricant on the battery cap threads to keep it from binding in the battery compartment.



For better battery performance, all DCI battery-powered transmitters ship with both a special battery contact spring and a nickel-based anti-seize lubricant on the battery end cap to aid in electrical contact.



Before use, inspect the battery cap O-ring for damage that may allow water to enter the battery compartment. Replace the O-ring if the one installed becomes damaged.

Do not use chemicals to clean the transmitter.

Placing tape around the fiberglass tube of the transmitter, if space allows, will keep the fiberglass protected from most corrosive and abrasive environmental wear. Do not tape over the IR port as this will interfere with IR communication.

Falcon 15-inch transmitters have a threaded hole (1/4"-20 thread) in the battery cap to allow the use of an insertion/extraction tool for installing and removing the transmitters in end-load housings. Ensure this hole remains clear of debris.

Send in the Product Registration Card or register online at access.DigiTrak.com within 90 days of purchase to enable the warranty on your equipment, including a 3-year/500-hour warranty on your transmitter. Ask your dealer about our extended 5-year/750-hour transmitter warranty.

Getting Started

Introduction



DigiTrak Falcon F2 Guidance System with Aurora® Remote Display

Congratulations on your purchase of the DigiTrak Falcon F2® guidance system. The Falcon wideband technology represents an important advancement in the detection of active interference at the jobsite. Falcon extends the performance range of the F2 receiver with a durable system that can be programmed to address the variability in jobsite interference.

In today's competitive underground drilling landscape of deeper bores and more challenging jobsites, interference has emerged as one of the primary obstacles to completing HDD installations on time. Interference varies from jobsite to jobsite, at different points within the same jobsite, and even with time of day. After extensive research and testing in some of the most challenging interference environments in the world, DCI concluded that selecting a transmitter frequency that sidesteps interference is far more effective at overcoming this obstacle than simply increasing power.

The Falcon approach involves dividing a wide range of frequencies into bands, then selecting the frequencies that are least susceptible to the interference in each band. Falcon F2 has nine bands that each use the best-performing of hundreds of frequencies between 4.5 and 45 khz. Optimize one band for best performance on the majority of the bore and the other for a high-interference segment. The system is easy to learn and simple to use every day. By following a few easy steps at the beginning of each pilot bore, you will be ready to drill within minutes.

Competing systems define success in terms of depth and data range. Falcon technology also provides tremendous range, but that isn't what makes Falcon great. DCI defines success as enabling crews to complete the largest number of jobs possible in the shortest periods of time. Falcon technology is designed around that principle.

The Falcon system comes standard with a receiver, transmitter, batteries, and battery charger. The separate operator's manuals for these devices are located on the flash drive that accompanied your guidance system and also at www.DigiTrak.com.

Using This Manual

This manual is an important tool for you as the operator of a Falcon guidance system. You can find it on the flash drive that accompanied your system or at www.DigiTrak.com. We encourage you to load it onto your mobile device and keep it handy so the information you need is always close at hand.



When something is worth a little extra attention, we'll mark it with this handy Notebook icon.



What if I have a question about this topic?

As you read this manual, you may have questions. We've already answered some of them right at the source in boxes like this. If the topic isn't for you, skip it and read on.



You might need this.

Sometimes it's handy to have some extra information at your fingertips. While it may be discussed in detail elsewhere in the manual, we've extracted and placed some important data right where you need it, with a page link if you want to read more.



Go watch some TV.

Subjects with training videos available online will be marked with this icon.

To help find those distant details, the manual includes hyperlinks that will take you right there, like this example:

Prior to use, the receiver must be paired to and calibrated with the transmitter.

[Calibration and AGR](#)

Page 19

Powering On





The regional designation number in the globes on the receiver startup screen and transmitter body must match. If they don't, contact your DigiTrak dealer.



Using the trigger.

Click the trigger to move between menu options. Hold briefly and release to make a selection. Do nothing in a menu for five seconds to return to the Locate screen.

Receiver

1. Install a fully charged battery pack.
2. Power on the receiver by holding the trigger briefly.
3. Click to accept the “Read the manual before using” statement. The subsequent information screen provides useful information such as software version and compatible transmitters. Click to advance.
4. First time use: from the **Main > Settings** menu , set the depth units, pitch units, and telemetry channel.
5. On the Main menu, set the optional Height-Above-Ground .

[Settings](#)
Page 23

[Height-Above-Ground \(HAG\)](#)
Page 17

Transmitter

Do not power on the transmitter until after running the frequency optimizer on the receiver (see next section). After that, or after resuming work (such as after lunch) using the same frequency bands, simply install batteries with the positive end first and completely fasten the battery cap.

[Batteries and Power On/Off](#)
Page 55

Remote Display (FCD)

1. Install a fully charged battery pack in the battery compartment.
2. Press the button to turn on the remote display.
3. First time use: from the **Main > Settings** menu , set the depth units, pitch units, and telemetry channel. Use the same settings as on the receiver. It is also good practice to use the same system of units (English or metric) on both devices.
4. Verify data is being received from receiver. If not, verify proper region is set on both devices.

If you are using a different remote display, refer to the separate operator's manual located on the flash drive that accompanied your guidance system and also at www.DigiTrak.com.

Setup Summary

Getting started with a Falcon F2[®] receiver is easy: run the frequency optimizer, walk and scan the bore path, pair the receiver with the transmitter, calibrate, check Above Ground Range, and check for active interference. It's all summarized in the following several paragraphs, with links to the details later in this manual. If you're hungry for the details now, skip to [Receiver](#) on page 9.

Select Frequency Optimizer

1. With the transmitter off (batteries not installed), take the receiver to the point along the intended bore that might create the biggest locating challenge, like the deepest point of the bore or where there is obvious active interference such as a railway crossing, transformer, traffic lights, or power lines.
2. Power on the receiver and select **Frequency Optimizer** (FO) from the Main menu. 
3. With the FO results active, walk the entire intended bore path with the receiver and note areas of high background noise (active interference). The higher a frequency band's bar is on the graph, the greater the interference. Note which band remains consistently low, since the band with the lowest level of interference will likely be the one you want to use.

[Frequency Optimizer](#)
Page 13

Assign Frequency Bands

1. On the receiver, click to move the selector on the bottom of the frequency optimizer graph to the band you want to use and hold briefly to select.
2. Assign as the Up or Down band.
3. Optional: select and assign a second frequency band.
4. Select **Pair** .
5. Insert batteries in the transmitter, positive end first, install the battery cap, and allow several seconds for the transmitter to fully power on and begin sending data to the receiver.
6. Align the receiver and transmitter IR ports within two inches of each other and select the check mark ✓ to pair. A successful pairing is indicated by a beep and a check mark.

Interference Check

Now that your transmitter is paired with your receiver, walk the bore with both the receiver and transmitter powered on to check for active interference on both frequency bands.

[Interference](#)
Page 33

[Changing Frequency Bands](#)
Page 59

Calibrate

Perform a separate 1-point (**1PT**) calibration for each newly optimized frequency band in a low-noise area with the transmitter in a housing. Always calibrate after assigning a new frequency band.

[Calibration](#)
Page 19

If you paired two bands and want to be able to switch between them later, calibrate both bands.

Above Ground Range Check

Perform an **Above Ground Range** check on the new optimized frequency band (or bands) before drilling. The AGR screen displays automatically after calibration.

[AGR](#)
Page 22

If the above-ground AGR distance at 50 ft. is not accurate, conduct a **50FT** calibration (which also uses only one point) to improve the accuracy of the above-ground distance measurement. A 50 ft. calibration is *not* necessary for drilling.

[50FT Calibration](#)
Page 23

The AGR check shows the distance between the receiver and transmitter without having to constantly hold the trigger, as when taking a depth reading at the locate line.

Drill

What are you waiting for? Start drilling. Or read on for more details and cool acronyms to know about the coolest locator on the planet.

Receiver



I know what a trigger switch is; can I skip this? [Page 12](#)

This section is like shaking hands with your Falcon for the first time. If you and your receiver already have a solid relationship, you can probably jump ahead to [Receiver Menu](#).



Falcon F2 Receiver – Side and Back Views

1. Screen
2. Front
3. Infrared port
4. Trigger switch
5. Battery tab
6. Battery compartment
7. Serial number

Overview

The The DigiTrak Falcon® F2® receiver (locator) is a handheld unit used for locating and tracking a Falcon wideband transmitter. It converts signals from the transmitter to display depth, pitch, roll, temperature, and battery level, plus sends this information to the remote display on the drill rig.

The receiver and transmitter must meet specific operational requirements for different global regions. A regional designation number is located on the receiver's startup screen. This number must match the one stamped on the transmitter for proper communication.

[Startup Screen](#)
Page 10

Prior to use, the receiver must be paired to and calibrated with the transmitter.

[Calibration](#)
Page 19

Trigger Switch

The Falcon receiver has one trigger switch located under the handle for operating the system. Use it to turn on the receiver, move through menu options, and change the screen view for depth readings. Click to cycle through options or hold briefly and release to make a selection.



I passed the menu option I want; do I have to keep clicking?

After several seconds of inactivity, the display returns to the Locate screen and you can try again.

Audible Tones

The Falcon F2 receiver beeps to signal power on/off, confirm menu changes, and acknowledge the pass/fail status of actions. The receiver also beeps with transmitter temperature increases.

[Transmitter Temperature Warning Tones](#)
Page 58

Two long beeps indicate a problem with the menu option selected and a failure screen will appear until you click the trigger or remove the battery (in the case of a critical failure). Verify your setup and try the operation again or contact DCI Customer Service for assistance.

Startup Screen

Insert a charged battery pack. To power on the receiver, click the trigger. After you have read the warning screen, click again to acknowledge you have read and understand this manual. The receiver displays the startup screen, which includes the results of several startup tests:

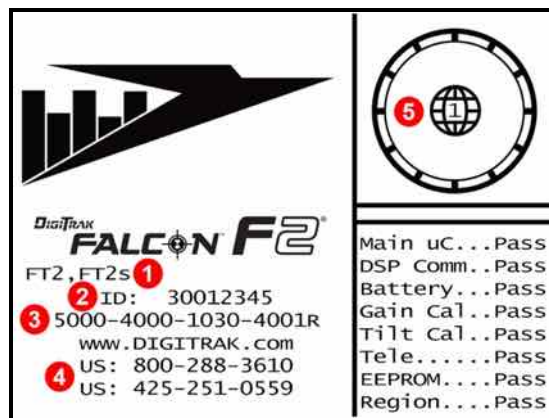

The image shows the Receiver Startup Screen, which is divided into two main sections. The left section features the Falcon F2 logo and a list of test results with numbered callouts (1-4) pointing to specific lines of text. The right section contains a circular indicator with a globe icon and a red '5' in a circle, followed by a list of test results with 'Pass' status. A legend on the right side of the image explains the numbered callouts.

<p>DCI FALCON F2</p> <p>FT2, FT2s 1</p> <p>2 ID: 30012345</p> <p>3 5000-4000-1030-4001R</p> <p>www.DIGITRAK.com</p> <p>US: 800-288-3610</p> <p>4 US: 425-251-0559</p>	<p>5</p> <p>Main uC...Pass DSP Comm...Pass Battery...Pass Gain Cal...Pass Tilt Cal...Pass Tele.....Pass EEPROM...Pass Region...Pass</p>	<p>1. Compatible transmitters</p> <p>2. Receiver ID number</p> <p>3. Software version</p> <p>4. Customer service phone numbers</p> <p>5. Regional designation number must match that of transmitter</p>
--	--	--

Receiver Startup Screen

Click to exit the startup screen. The Falcon F2 receiver proceeds to the Locate screen.

[Locate Screen](#)
Page 30



If an item of the self-test fails, a "Fail" warning displays on the startup screen instead of "Pass". An exclamation mark (!) may also appear in the roll indicator on the Locate screen. Please contact DCI Customer Service.

Adjusting Screen Contrast



To make the screen lighter or darker, hold the trigger while on the Locate screen with the receiver held vertical. Release the trigger when the screen contrast reaches the desired level.



The contrast changed way too much; how do I change it back?

Keep holding the trigger; the contrast will adjust completely dark or light, then adjust in the opposite direction.

Your Remote Display

The Falcon F2 receiver is compatible with the following remote displays:

Remote Display	Minimum Software Version	Select on Remote Display
Falcon Compact Display - FCD	4.0	Falcon F2
Multi-Function Display - MFD	3.0, F2 compatible	F2
F Series Display - FSD	all	F2
Aurora - AP8, AF8, AF10	all	Falcon F2

A remote display that accompanied your Falcon F2 receiver will already be set to communicate with your receiver.

If you purchased your Falcon receiver by itself, your existing remote display may not include the required option. If so, contact your regional DCI office or Customer Service for a software upgrade.

The operator's manuals for these remote displays are located on the flash drive that accompanied your Falcon system and also at www.DigiTrak.com. For an MFD, use the FSD manual.

Receiver Menus



I am already familiar with DigiTrak receiver menus; can I skip this? *Page 29*

If you have used a DigiTrak SE® or F2® receiver, you are well on your way to mastering a Falcon. Read the next section on the Frequency Optimizer, then skip ahead to [Locating Basics](#). Come back and visit later as needed for reference. If this is your first DigiTrak, keep reading.

To access the Main menu from the Locate screen, click the trigger. Click repeatedly to move through the menu, then hold the trigger briefly and release to make a selection. The Frequency Optimizer icon is shown selected below; holding the trigger briefly would start this feature.

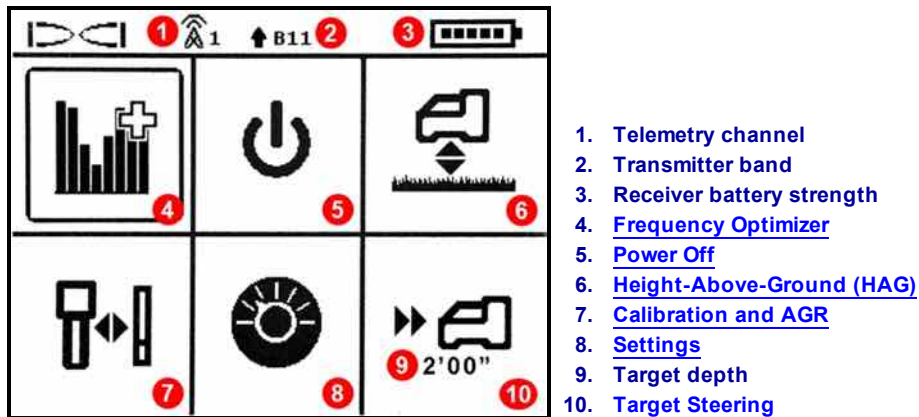

Receiver Main Menu

The top of the Main menu displays the telemetry channel, transmitter frequency band, and receiver battery strength.

The following sections describe the Main menu items in order. Use the links above to jump straight to a section.

If the Target Steering menu has been programmed with a target depth, it displays below the Target Steering icon as shown.

If you open the Main menu accidentally, either click through all the options to return to the Locate screen or wait a few seconds for the menu to time out and return automatically.

Frequency Optimizer



This section addresses Falcon technology's ground-breaking frequency optimizer (FO) feature, which finds the lowest-noise (optimal) group of frequencies available in each of nine bands. When the results display in graph form showing the levels of active interference in each band, choose the one or two bands you want to use, pair, and you're ready to calibrate and start drilling.

You can switch the transmitter between the two optimized bands at any time, either pre-bore or mid-bore. Start in the optimized band that works best for the normal-interference portion of the bore and switch to the other band that works better for the portion that has higher interference. Or use one optimized band for the whole bore, or start drilling in one optimized band and switch only if you need to. The choice is yours.



Do I have to optimize every time I power the receiver on? *Page 55*

No, the receiver remembers both optimized bands until you pair it to a new band. Power the transmitter on horizontally to use the last active band. But don't forget to optimize at your next bore.

If my optimized band worked great at my last jobsite, can I keep using it at my next one?

Because sources of interference differ at every jobsite, DCI recommends optimizing at every jobsite to obtain the best selection of frequencies for the current conditions.

To optimize and select a frequency band:

1. Ensure all transmitters are powered off or are more than 100 ft. away from the receiver.
2. Take your receiver to the point along the proposed bore that you expect to have the greatest amount of noise (active interference).
3. With the receiver parallel to the bore path, select **Frequency Optimizer**  from the Main menu.

The Falcon F2 receiver scans and measures the background noise (active interference) in multiple frequencies. The display will cycle through each band for about 15 seconds as shown below while it is scanning.

-90 to -72 dB Low interference levels

-72 to -54 dB Moderate interference

-54 to -18 dB Interference will become an issue as depth increases

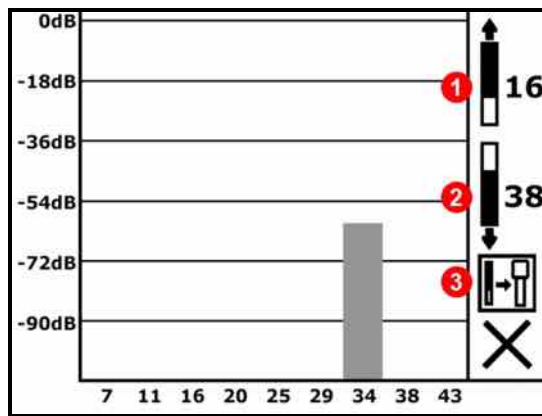

1. Current Up band
2. Current Down band
3. Pair

Frequency Optimization Graph while Scanning

When frequency optimization is complete, the receiver shows active noise readings in each of the nine frequency bands using an optimized selection of the lowest-noise frequencies within each band. The shorter the bar on the graph, the less interference present in that band.

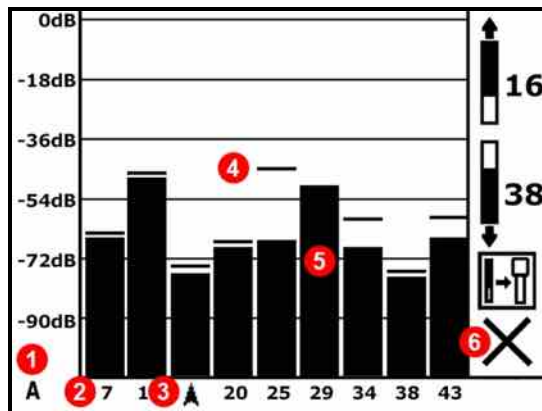

1. Attenuation in effect
2. Band number
3. Band selector
4. Maximum noise reading
5. Current optimized noise readings
6. Exit

Frequency Optimizer Results

4. To measure noise readings from the entire intended bore, simply walk the bore with the frequency optimizer results displayed, keeping the receiver parallel to the bore path. As the receiver continues sampling background noise, it marks the maximum noise reading of each band at the top of each bar.



Optimize as often as you want. You can't wear it out.

If noise levels rise substantially at any point along the bore, consider selecting and pairing one band (see next step) that performed well up to this point. Then select **Exit** and restart FO at this point to perform a new scan and select and pair a second band for use in this higher-interference area. Optimize as often as you want and wherever you want before assigning a band.

- Click to move the selector to the band you want to use and hold briefly to select. Typically this will be a band with a low interference level that did not experience high maximum noise readings along the bore path. The band number represents the approximate middle kHz frequency of each band.

Band Number	7	11	16	20	25	29	34	38	43
Range in kHz	4.5 – 9.0	9.0 – 13.5	13.5 – 18	18 – 22.5	22.5 – 27	27 – 31.5	31.5 – 36	36 – 40.5	40.5 – 45



Are high frequency bands better than low frequency bands?

Interference varies with time and location, and no band works perfectly in all conditions. Different bands are better for different kinds of interference. Lower frequency bands tend to perform well despite passive interference. Middle bands can perform better in deeper bores and may have longer Target Steering capability. High bands have slightly less signal strength but tend to offer better performance around active interference such as power lines.

- Select whether to assign this as the Up or Down band (the band the Tx powers on with when facing Up or Down).



Up Down Cancel

- Optional: click to select a second band, then assign as the opposite (Up or Down) band; changing both bands is not required.
- The receiver displays the transmitter pairing screen. Insert batteries in the transmitter, install the battery cap, and wait 15 seconds for the transmitter to fully power on. The increase in frequency optimizer noise readings show the transmitter is on.
- Select **Pair** . If you assigned two new bands, both will pair at the same time.
- Position the infrared (IR) port of the transmitter within 2 in. of and facing the IR port on the front of the receiver.

[Transmitter](#)
Page 54



1. Transmitter IR port

11. Select the check mark ✓ to pair the transmitter frequency band to the receiver.

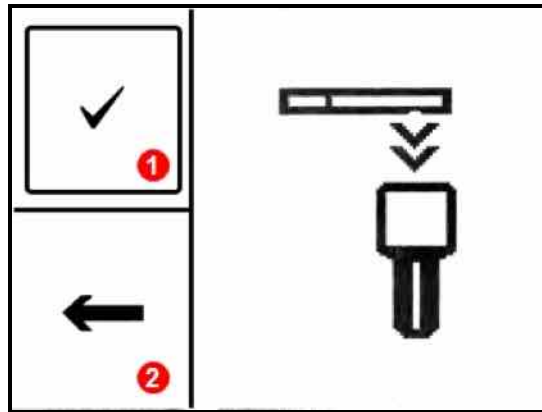

1. Pair
2. Return to optimizer results

Transmitter Infrared (IR) Pairing Screen

Hold the transmitter in place for up to ten seconds for pairing. A circling icon indicates the receiver and transmitter are not yet connected; check alignment and proximity of the IR ports. Moving the transmitter during pairing may cause an error code to display on the screen; if this happens, simply restart the pairing process. Earlier generation transmitters may take as long as 20 seconds to pair.



Can I exit the pairing screen and go back to the optimizer results without running it again?

Yes. Select **Return** ← to go back to the optimizer results. Maximum readings will be reset and you can continue observing the noise readings of the last optimized frequency bands. Selecting **X** to return to the Locate screen will erase optimization results.

When the pairing is successful, the receiver/transmitter icon briefly changes to a check mark and the receiver beeps. Both the receiver and transmitter are now using the new optimized band(s) you selected. If you assigned two new bands, the system defaults to using the Down band first.

- If the pairing is unsuccessful, the receiver/transmitter icon will briefly change to an **X** and then the Transmitter Pairing screen will reappear. Try pairing a second time. If still unsuccessful, remove and reinstall the transmitter batteries (positive end first) and battery cap, realign the two IR ports, and try again. If still unsuccessful, **Return** ← to the FO results and go back to step 5.
- If the pairing doesn't complete, no new optimized frequency is stored in the receiver. Upon exiting the **Frequency Optimizer** screen, the receiver remains paired to the transmitter at the last optimized bands used.
- As mentioned at the end of step 4, the second band can be paired to a completely different optimization. If you just paired one band but want to re-optimize at a different location for the other band, simply run the frequency optimizer at the new location (step 1), select a band, and assign as the opposite (Up or Down) band.

So I Just Paired, Now What?



After pairing, the receiver proceeds to the calibration screen as a reminder that with the selection of a new frequency band, the transmitter and receiver need to be calibrated. Install the transmitter in the drill head and calibrate.

[Calibration](#)
Page 19



Prior to calibration, "Calibration required" is indicated on the Locate screen by an error symbol in the roll indicator in place of the roll value. To change between bands mid-bore, both bands must be separately selected and calibrated prior to drilling.



Before or during drilling, switch between bands any time if interference is compromising the current band.

[Changing Frequency Bands](#)
Page 59

After pairing optimized frequency bands, for typical operations your next steps before drilling would be:

[Above Ground Range](#)
Page 22

- calibrate
- check Above Ground Range (AGR)
- check for background interference

[Interference](#)
Page 33

Complete each of these checks on both optimized frequency bands.

Power Off

Select **Power Off** from the Main menu to turn the receiver off. The receiver automatically shuts down after 15 minutes of inactivity, or after 30 minutes when in Target Steering mode.



Is it okay to power off by pulling the battery out?

Yes, your Falcon can handle it.

Height-Above-Ground (HAG)

Use **Height-Above-Ground (HAG)** to set a height measurement on the receiver so you don't have to set it on the ground for a depth reading. Raising the receiver above the ground also provides separation from underground interference that might otherwise reduce the transmitter's range or cause variable readings.

To prevent incorrect readings, Falcon always powers on with the HAG function off (disabled). HAG also automatically shuts off during calibration and when you change depth units, and is ignored during Target Steering and AGR tests. Until you enable HAG, the receiver must be placed on the ground for accurate depth readings.

[Calibration](#)
Page 19

[Depth Units](#)
Page 28

[AGR Test](#)
Page 22

[Target Steering](#)
Page 48



I use HAG all the time; can I set it to turn on automatically?

No. In the name of safety, HAG must be turned on manually for each use. However, the feature does remember the last height value used.

To determine your desired HAG distance, hold the receiver comfortably at your side, maintaining 8 in. of separation from the front of the receiver to your torso as specified in the Safety section on page 1. Measure the distance from the bottom of the receiver to the ground. HAG may be set from 12 to 36 inches.

The HAG menu has three options: Turn on, Turn off, and Set. Click the trigger to reach the desired option, then hold briefly to select.

Turn HAG On

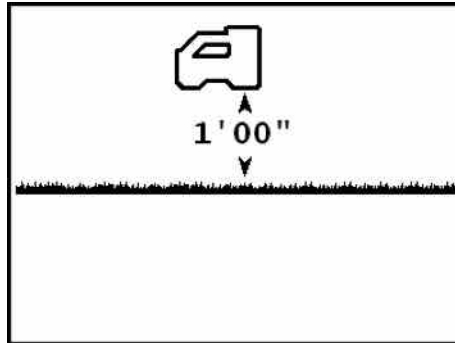

Turn HAG On

To set a different value for HAG or to turn it off, click the trigger to advance to the next screen and skip the rest of this section. Otherwise, continue below.

This **Turn HAG On** screen shows the Falcon receiver 1 ft. above the ground. To turn HAG on using the height value displayed, hold the trigger briefly. The receiver beeps and confirms with a check mark ✓ to indicate HAG is now on, then returns to the Locate screen.

Depth readings (holding the trigger) must now be taken with the receiver held at this height.

Turn HAG Off

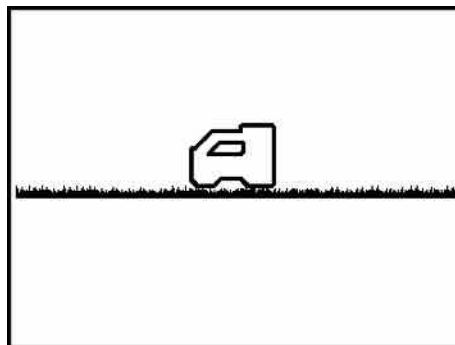

Turn HAG Off

To set the HAG distance, click the trigger to advance to the next screen and skip the rest of this section. To turn HAG off, continue below.

The **Turn HAG Off** screen shows the receiver on the ground.

Hold the trigger briefly to turn HAG off. The receiver beeps and confirms with a check mark ✓ to indicate HAG is now off, then returns to the Locate screen. The receiver must now be placed on the ground to obtain accurate depth readings.

Set HAG Value

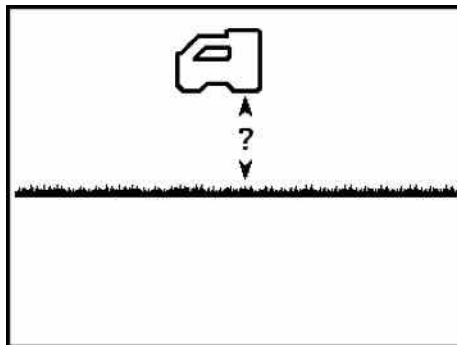

Set HAG Value

Use the **Set HAG Value** screen to input the height at which the receiver will be held above the ground when HAG is on.

A question mark initially appears in place of the HAG value.

Hold the trigger briefly to set the HAG value. The current or default HAG setting displays in place of the question mark. Click to scroll through the available height-above-ground values of 12 to 36 in., then hold the trigger at the desired HAG value. The receiver beeps and confirms with a check mark, then enables HAG and returns to the Locate screen.

Depth readings (holding the trigger) must now be taken with the receiver held at this height.

As noted above, to prevent incorrect readings, HAG must be turned on manually each time after the receiver is powered on or calibrated.

Calibration and AGR

Use the **Calibration** menu to calibrate the receiver to a transmitter and to verify the Above Ground Range (AGR). Calibration is required prior to first-time use and before using a different transmitter, receiver, drill head, or optimized transmitter band. Calibration is not necessary, however, when switching between bands on a transmitter that are already paired and calibrated.



Calibrate each band separately

If you select an optimized band that has not been calibrated yet,  appears in the roll indicator. Calibrate and verify Above Ground Range separately for each optimized frequency band prior to each job. Calibration affects depth readings, but not roll/pitch.

Do not calibrate if:

- You are within 10 ft. of metal structures, such as steel pipe, chain-link fence, metal siding, construction equipment, automobiles, etc.
- The receiver is over rebar or underground utilities.
- An **A** is displayed at the bottom left of the roll indicator on the locating screen, as this indicates signal Attenuation is in effect, likely due to excessive interference. If possible, relocate to a quieter location before calibrating.
- The receiver is in the vicinity of extreme interference, as shown by high background noise readings on the frequency optimizer graph or a flashing signal strength value on the locate screen along with the **A** icon (calibration is prohibited when the signal strength is flashing).
- The receiver is not displaying transmitter data.
- The signal strength from the transmitter is less than 300 points (too low) or greater than 950 points (too high). Outside this range, a calibration failure screen will indicate low or high signal strength.

[Attenuated Signal](#)

Page 64

[Frequency Optimizer](#)

Page 13

[Installing Batteries /](#)

[Power On](#)

Page 55

The transmitter must be installed in a drill head during calibration.

During calibration, Height-Above-Ground (HAG) is automatically turned off. After calibration, HAG must be turned back on manually.

[Height-Above-Ground \(HAG\)](#)

Page 17

1-Point Calibration

Calibrating depth readings is accomplished above ground, prior to drilling.

1. Place the receiver and the transmitter (in a drill head) parallel to each other on level ground, with both devices powered on.
2. With the receiver at the Locate screen, verify that roll and pitch values are being displayed and that a steady signal is being received from the transmitter. The transmitter's signal strength at calibration is available on the second page of the Settings menu. A change in signal strength at 10 ft. later can indicate you are currently in an interference environment or there is a problem with your equipment.
3. Move the locator within 2 ft. of the transmitter to enable signal [attenuation](#), indicated by an **A** at the bottom left of the roll indicator. Move the locator back to 10 ft. away and verify attenuation turns off. If it does not, excessive noise may be present.

- At the Main menu, select **Calibration**  and then **1PT CAL** (1-point calibration).

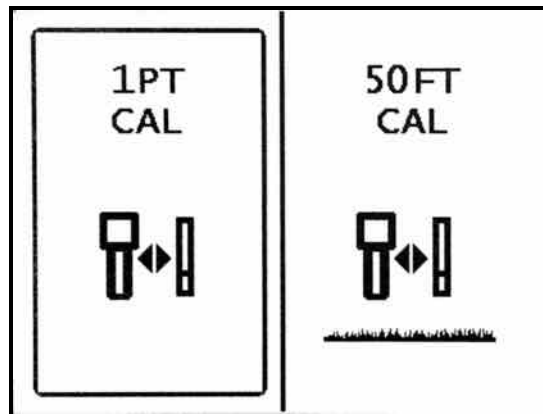

Receiver Calibration Screen

- Use a tape measure to ensure the distance from the center of the transmitter to the inside edge of the receiver is 10 ft. as shown below, then click to begin the calibration.

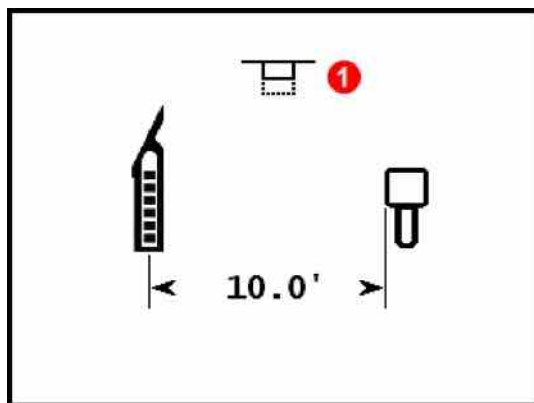



1. Trigger click prompt (flashes)

Calibration Prompt

If you wait longer than about 15 seconds to click the trigger, the calibration terminates and the Above Ground Range (AGR) screen displays (see next section).

- The display counts down to zero while the receiver records the calibration point. Do not move the receiver.
- A successful calibration yields a check mark above the transmitter icon and four beeps. An unsuccessful calibration yields an **X** above the transmitter icon and two beeps.



The  symbol indicates low signal strength, and  indicates high (excessive) signal strength. Calibration will fail when the signal from the transmitter is below 300 or above 950 points. Calibration will also fail if extreme signal [attenuation \(A\)](#) is in effect.

Continue with AGR in the next section to verify above-ground distances for this calibration.

If necessary, turn Height-Above-Ground (HAG) back on.

[Height-Above-Ground \(HAG\)](#)

Page 17



Why do I keep getting calibration errors?

Carefully review the items under [Do not calibrate if](#) at the beginning of this section. Try calibrating in a different location. Make sure the transmitter is on and paired (data showing on the Locate screen). If you're still having trouble, give us a call, we'll get you going.

Above Ground Range (AGR)

After successfully completing a 1-point calibration, the receiver displays the **Above Ground Range** screen, which is an active measurement between the transmitter and receiver. Use this screen along with a tape measure to verify calibration of the transmitter at different depths/distances. With the transmitter level, the depth readings should be within $\pm 5\%$ of the measured distance.



AGR: It's Just What You Do

Performing an AGR test on both frequency bands at every jobsite is just good practice.



To perform an AGR check without re-calibrating the transmitter, follow the [1-point calibration](#) instructions in the previous section but do not click the trigger to perform the calibration. The procedure will default to the AGR screen after several seconds.



Note that because AGR intentionally does not consider pitch when calculating range, it displays a symbol indicating "Warning, pitch is unknown, assume zero". It also ignores any HAG setting.

[Pitch Assumed Zero](#)

Page 30

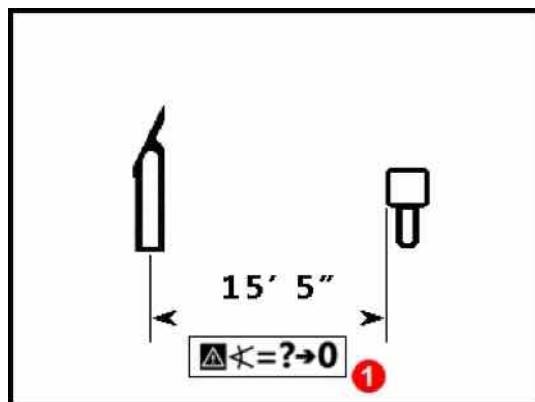

1. Pitch assumed zero

Above Ground Range (AGR)

If you just completed AGR after calibration, don't forget to turn Height-Above-Ground (HAG) back on, if necessary.

[Height-Above-Ground \(HAG\)](#)

Page 17

50 Foot Calibration (Optional)

This feature is primarily used for demonstrations of the guidance system above ground and is not necessary for drilling. Above ground range (AGR) measurements beyond 40 ft. often read shallower (shorter) than they actually are due to variations in ground conditions, and this feature calibrates these measurements to account for these variations. Using this feature is substantially similar to the procedure described for [1 pt calibration](#); if you require further information, please contact DCI customer service.

Settings

Use this menu to set the following options:

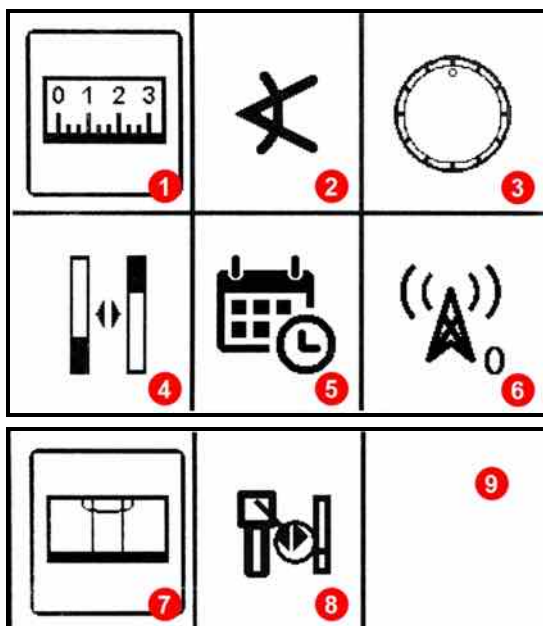

1. [Depth Units Menu](#)
2. [Pitch Units Menu](#)
3. [Roll Offset Menu](#)
4. [Transmitter Options Menu](#)
5. [System Timer Menu](#)
6. [Telemetry Channel Menu](#)
7. [Bubble Level](#)
8. [Signal Strength Values](#)
9. [Page 2](#)

Settings Menu

Click the trigger to move between options, hold briefly to select. DCI recommends that you program the receiver and the remote display Depth and Pitch settings to use the same units of measure.

For each option, an arrow indicates the current setting. Click to switch between options, then hold briefly to select. A check mark confirms the selection and the receiver beeps four times as it returns to the Locate screen. To make no changes, wait a few seconds to return to the Locate screen.

Depth Units Menu

Choose between **000"** inches, **0'00"** feet and inches, **0.00 M** metric units (meters and centimeters), and **0.00'** decimal feet.

Selecting metric units will cause the temperature to display in degrees Celsius. All other options will cause the temperature to display in degrees Fahrenheit.

Changes to depth units will turn the Height-Above-Ground (HAG) setting off and reset the height value to 1 ft. After changing depth units, if necessary, turn HAG back on and reset the height value.

[Height-Above-Ground \(HAG\)](#)



Page 17

Pitch Units Menu

Choose between degrees (0.0°) and percent (0.0%). Typical HDD bores use percent pitch instead of degrees.

Roll Offset Menu

Use this menu to electronically match the 12:00 position of the transmitter to that of the drill head. To set and enable roll offset, the receiver must be showing actual clock values.

1. Roll the drill head to the 12:00 position. The transmitter will display its actual roll value.
2. From the **Settings**  menu, select **Roll Offset** .
3. Select **Activate Roll Offset**.

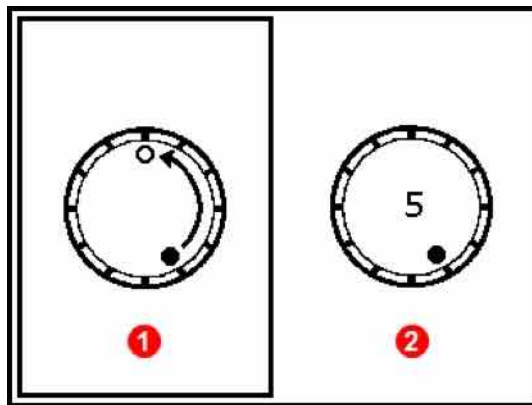

1. **Activate Roll Offset**
2. **Disable Roll Offset**

Roll Offset Menu

The receiver activates roll offset, showing the transmitter's actual roll value while the drill head is at 12:00.

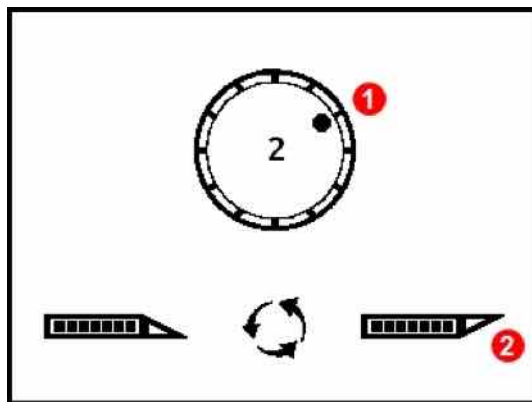

1. **Transmitter's true roll position with housing at 12:00**
2. **Drill head at 12:00**

Roll Offset Enabled

4. With the actual roll showing (in this example, 2:00), hold the trigger briefly to set the offset and correct to 12:00.

When the receiver returns to the Locate screen, roll offset is indicated by a hollow dot in place of the solid dot on the roll indicator and the letters “RO” at the bottom right of the roll indicator on both the receiver and remote display.

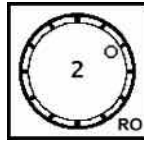

Roll Offset Enabled

To disable roll offset, select Disable Roll Offset from the Roll Offset menu. The receiver beeps four times as the screen returns to the Locate screen. The roll value on the Locate screen will now be that of the transmitter, not necessarily the drill head.

Transmitter Options Menu

Use this menu to select between optimized Up and Down frequency bands, select a DucTrak transmitter, view a frequency analyzer that shows the current interference on the band, and view information about the paired transmitter.

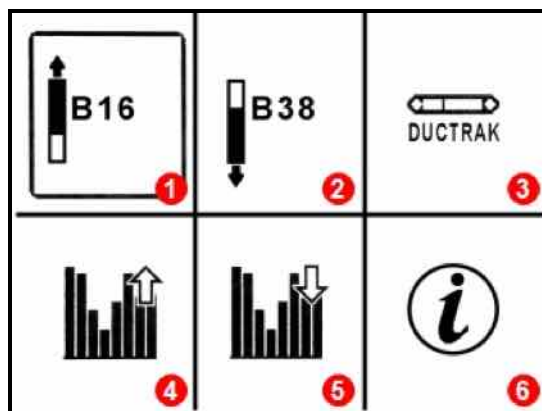

1. Select Up band
2. Select Down band
3. Select DucTrak
4. Frequency analyzer for Up band
5. Frequency analyzer for Down band
6. Tx information and runtime

Transmitter Options Menu



1. Pointed up
2. Pointed down
3. Battery compartment

Select the Up Frequency Band

Sets the receiver to receive transmitter data on the optimized Up band.

To power on the transmitter in the Up band, insert batteries with the transmitter pointing up (battery compartment on the bottom).

[Batteries and Power On/Off](#)

Page 55

Select the Down Frequency Band

Sets the receiver to receive transmitter data on the optimized Down band.

To power on the transmitter in the Down band, insert batteries with the transmitter pointing down (battery compartment on top).

DucTrak

Sets the receiver to use a DucTrak transmitter. DucTrak is used for tracking existing ductwork and piping only, not for drilling. A DucTrak transmitter does not require pairing but must be calibrated to provide correct depth readings.

Frequency Analyzer

This function shows the current active interference levels in the optimized Up or Down frequency band. One or more bars in the optimizer graph will be higher if the receiver is near a source of active interference (as an experiment, hold the receiver near a television or computer monitor and watch the bars jump).

You may optionally select and pair a different optimized band from this screen. If so, remember to calibrate again prior to drilling.

Transmitter Information

Select this option to view information about your transmitter, including serial number, maximum temperature, and the active runtime meter used for the warranty. It's also a handy way to double-check that the receiver is able to communicate (pair) with the transmitter.

Position the recessed infrared (IR) port of the transmitter within 2 in. of and facing the IR port on the front of the receiver, then select **Transmitter information** .

SN:	30095917
Region:	1
Band:	16k\34k
Current:	0.099A
Voltage:	2.839V
Temp:	75° F
Max Temp:	75° F
Version:	2.0.3.0
Active Runtime: <1 hour	

Transmitter Information

Click to return to the Main menu.



Your locator may need an upgrade to series 5000 software to read Active Runtime.

System Timer Menu



This menu option is for dealer use only.

Telemetry Channel Menu



This menu has five telemetry channel settings (1, 2, 3, 4, and 0). For communication to occur between the receiver and remote display, both devices must be set to the same telemetry channel.

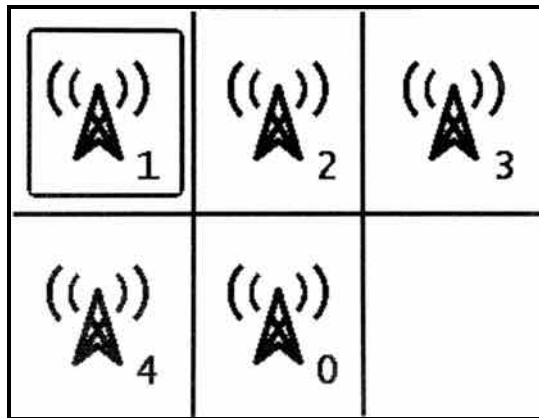

Telemetry Channel Menu

To turn telemetry off and conserve receiver battery life, select “0”. Channel 0 is also used when there are more than four receivers operating in the same area; using more than one receiver per channel within telemetry range of each other will cause conflicting signals to be sent to the remote display on the drill rig.

Click to select the desired telemetry channel on the receiver, then hold briefly to set. The receiver beeps four times and confirms with a check mark ✓, then returns to the Locate screen. The current telemetry channel displays next to the Telemetry Channel icon on the Main menu.

Bubble Level

Use this digital bubble level to find level or establish the slope of terrain. The readings will be in percent or degrees slope depending on your pitch units selection.

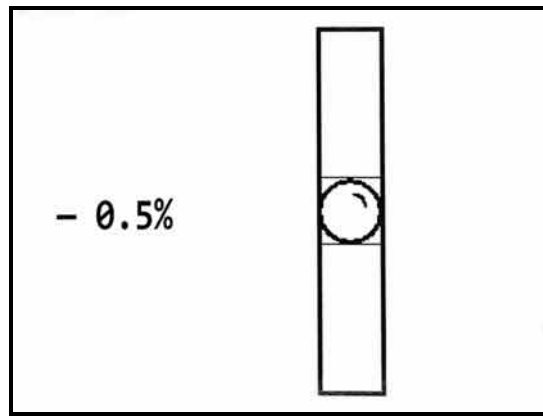

Bubble Level

Signal Strength Values

This screen shows the signal strength values for each optimized band as of its last calibration. Though this window lists all transmitters compatible with your receiver, only transmitter bands calibrated to your receiver will display data in the **Signal** and **Last Cal** columns.

Type ¹	kHz	Signal ²	Last Cal ³
Up	16	703	15 days
Down	34	685	23 hours
Ductrak	12	667	<1 min

- 1. Type
- 2. Signal strength
- 3. Time since last calibration

Signal Strength Values

Target Steering

The last item on the Main menu is for using the DigiTrak *Target Steering*[®] locating method, which is discussed later in the Advanced Locating section of this manual.

[Target Steering](#)
Page 48

Locating Basics



Are you ready? *Page 33*

If you're new to locating and first want to know everything about the locating screens, you've come to the right place. If you already know locators and want to jump right in and start locating with your Falcon F2 system, skip to **Interference**.



Locating in a High-Interference Area

This section covers locating basics:

- [Locating screens](#)
- [Checking for interference](#) and suggestions for dealing with it
- [Performing a roll/pitch check](#)
- Finding and marking [front and rear locate points](#) (FLP and RLP) and the locate line (LL) to pinpoint the transmitter
- The [geometry](#) of the FLP, RLP, and LL with respect to the transmitter
- Methods to [verify depth readings](#)



Refer to the DigiTrak YouTube site at www.youtube.com/dcikent for helpful videos on these and many other locating topics.

Locating Screens

The Locate, Depth, and Predicted Depth screens are the primary screens you will use for locating. The type of depth screen that displays depends on the position of the receiver relative to the transmitter at the time of the depth reading.



Do I have to know all this? *Page 39*

Get this down first, then you'll be ready to locate like a professional. If you skip to [Locating the Transmitter](#) and feel like you're missing a little background information, come back here for a refresher.

For a description of the icons on the Locate screens, see [Appendix B](#) on page 64.

Locate Screen

When the receiver is detecting a signal from a transmitter, the Locate screen provides real-time data about the transmitter's location, temperature, pitch, roll, and signal strength.

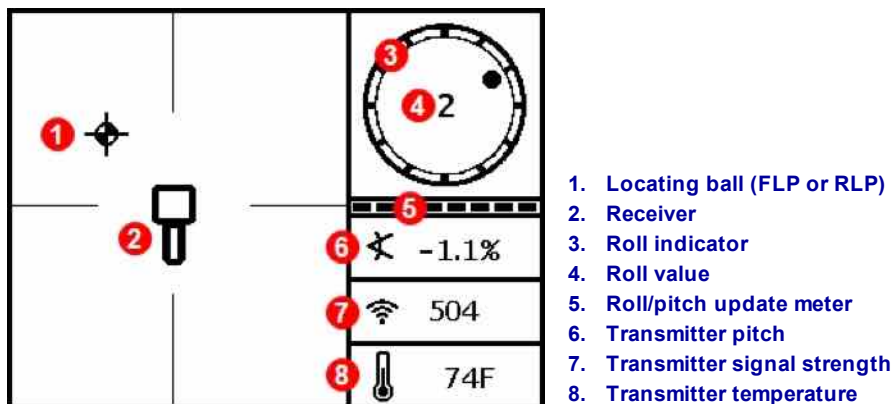

Locate Screen with Transmitter in Range

If the transmitter is on and there is no roll or pitch data, hold the trigger for five seconds to engage Max Mode and the data should appear. If no data appears, the transmitter and receiver may not be on the same frequency band.



How do I check which frequency bands are assigned?

The current band in use is listed at the top of the Main menu (page 12). Or, from the Main menu, select **Settings** > [Transmitter Options](#) (page 25) to see both optimized bands.

The roll/pitch update meter displays the quality of roll/pitch data being received from the transmitter. When the meter is empty, no roll/pitch data is being received, and none will appear on either the receiver or the remote display. Depth and predicted depth readings may still be taken, but the receiver will assume the transmitter has a pitch of zero, as indicated by the image to the right appearing on the Depth or Predicted Depth screen.

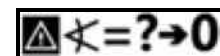

**Pitch Assumed
Zero**

Locate Screen Shortcuts

The following shortcuts are available from the Locate screen.

Task	Operation	Page
Depth Screen	Hold trigger at locate line (LL)	31
Max Mode	Hold trigger at least five seconds	32
Main Menu	Click trigger	12
Predicted Depth Screen	Hold trigger at front locate point (FLP)	32
Screen Contrast	Hold trigger with receiver vertical	11

Less Common Icons

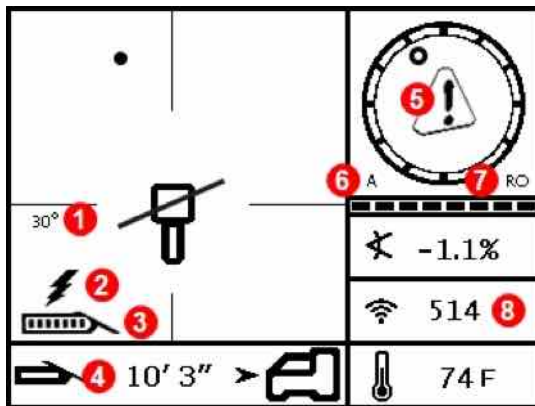

1. Transmitter yaw
2. [Transmitter \(Tx\) current draw warning](#)
3. [Tx battery strength](#)
4. [Target Steering](#)
5. [Calibration required or self-test error warning](#)
6. [Attenuated Signal](#) (shallow depth or excessive interference)
7. [Roll Offset](#) menu enabled
8. When flashing, indicates severe interference

Locate Screen with Less Common Icons

Depth Screen

Hold the trigger with the receiver at the locate line (LL) to display the Depth screen.

[Locate Points \(FLP & RLP\) and Locate Line \(LL\)](#)

Page 37

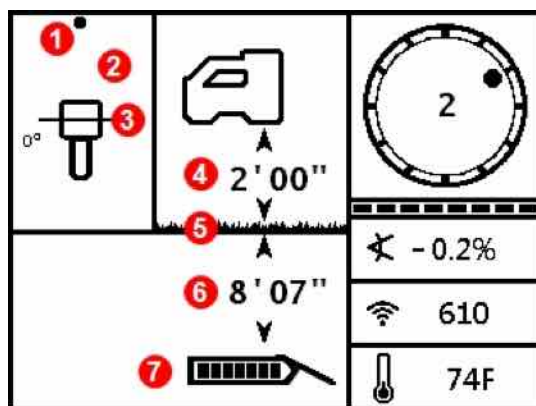

1. Locate point (front or rear)
2. Bird's-eye view
3. Locate line (LL)
4. Height-Above-Ground (HAG) setting on
5. Ground level
6. Transmitter depth
7. Tx battery strength

Depth Screen at LL with HAG On

When the HAG setting is disabled, the receiver will be shown on the ground and must be placed on the ground during depth readings.

[Height-Above-Ground \(HAG\)](#)

Page 17

Max Mode

Max Mode can stabilize roll/pitch data and depths readings when drilling at the very limit of the ability of the transmitter due to extreme depth or interference, which will vary by jobsite.

When the roll/pitch update meter shows low signal level or data is unstable, hold the trigger for longer than five seconds to enter Max Mode, indicated by a magnifying glass around the pitch icon.

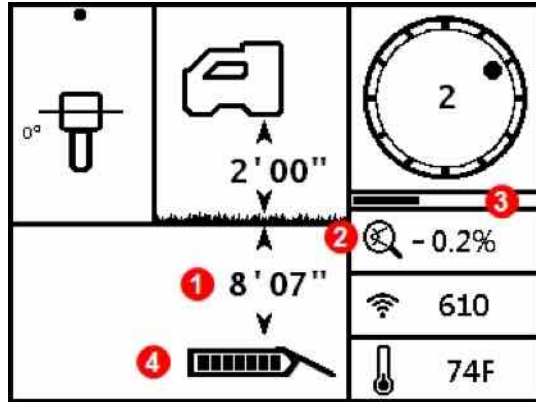

1. Depth
2. Max Mode icon
3. Max Mode timer
4. Tx battery strength

Depth Screen in Max Mode

Max Mode replaces the roll/pitch update meter with the Max Mode timer. As you hold the trigger and Max Mode gathers data readings, the timer slowly fills up. Greater interference or deeper bores will require a higher number of readings before roll/pitch data displays, or may prevent data from displaying altogether. If the timer is full and data is not yet stable, release the trigger, move to a different location near the drill head, and hold to restart.

Always take **three** Max Mode readings; all three readings must be consistent and each reading must stabilize before the Max Mode timer is full.



The drill head must be stationary when taking readings using Max Mode. **If the drill head is moving, data readings will not be accurate.**

Due to the nature of the extreme depth and/or high-interference environment where use of Max Mode will typically occur, the risk of obtaining unreliable data is higher. Never rely on data that does not display quickly and remain stable. Max Mode is never a substitute for prudent operator judgment.

Predicted Depth Screen



Because both [front and rear locate points](#) (see page 37) appear identical to the receiver, an invalid depth prediction can be generated when the receiver is over the rear locate point (RLP). Only a depth reading over the *front* locate point (FLP) produces a valid predicted depth.

Hold the trigger at the front locate point (FLP) to display the Predicted Depth screen. The predicted depth is the depth the transmitter is calculated to be at when it reaches the front locate point if it continues on its current path.

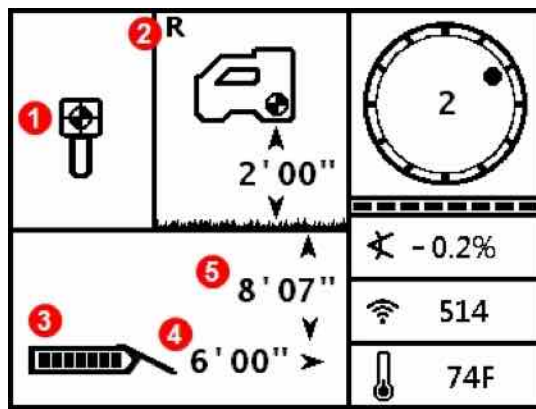

1. *Ball-in-the-Box™* at FLP
2. **Reference Lock** indicator
3. Tx battery strength
4. Horizontal distance between transmitter and FLP
5. Predicted depth of transmitter

Predicted Depth Screen at FLP with HAG On

Hold the trigger for longer than five seconds to enter Max Mode, as described in the previous section (use of Max Mode has special requirements and restrictions). In this example, if the drill head travels an additional 6'00" at -0.2 % pitch, it will be directly below the locator at 8'07".

Depth Screen, Invalid Location

Hold the trigger at any time during locating to display the Depth screen. No depth or predicted depth will appear if the receiver is not positioned at the locate line or front or rear locate point. However, holding the trigger more than five seconds to enter Max Mode may obtain more stable roll/pitch data (use of Max Mode has special requirements and restrictions).

[Max Mode](#)
Page 32

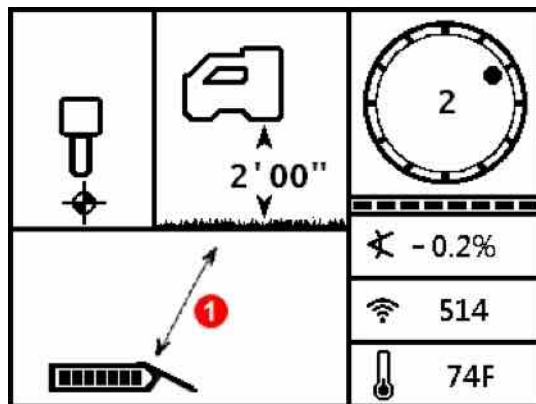

1. Slanted line indicates receiver is not at FLP, RLP, or LL

**Receiver Depth Screen with HAG Enabled
(not at FLP, RLP, or LL)**

Interference

Interference can compromise a transmitter's signal even when drilling with an optimized frequency band. It is important to the success of your bore that, after pairing your transmitter at a newly optimized frequency, you check how the transmitter's signal will perform along the intended bore path.



To best overcome interference, find and deal with it above ground, before you start drilling.

What is Interference?

Interference can reduce the transmitter's range or cause variable readings and possibly result in job slowdowns. Interference is classified as either *active* or *passive*.

Active interference, also known as electrical interference or background noise, can have varying effects on locating equipment. Most electrical devices emit signals that can inhibit the ability to locate the transmitter accurately or get good roll/pitch readings. Example sources of active interference include traffic signal loops, buried dog fences, cathodic protection, radio communications, microwave towers, cable TV, fiber-trace lines, utility data transmissions, security systems, power lines, and phone lines. Interference at the remote display may also occur from other sources operating nearby on the same frequency. The following section describes how to use the receiver to test for the presence of active interference.

Passive interference can reduce or increase the amount of signal received from the transmitter, which results in incorrect depth readings, a completely blocked signal, or locates in the wrong position. Example sources of passive interference include metal objects such as pipes, rebar, trench plate, chain-link fence, vehicles, saltwater/salt domes, and conductive earth such as iron ore. The receiver cannot test for the presence of passive interference. Conducting a thorough site investigation prior to drilling is the best method of identifying passive interference sources.

To familiarize yourself with the interference potential along your intended bore path, check for background noise as discussed in the following section.



A receiver cannot detect sources of passive interference; this can only be accomplished with a visual inspection of the jobsite. A background noise check can only find *active* interference.



I thought the Frequency Optimizer did all this for me?

The Frequency Optimizer finds the lowest-noise frequencies to use in each band. You choose which bands to use and pair the transmitter. As best practice, now test those bands above ground to ensure the receiver can receive data for the entire length of the bore. A good background noise check is vital to a job free of interference surprises.

Checking for Interference

Ensure the receiver is on, optimized, and paired. Remove the batteries from the transmitter to turn it off and wait 10 seconds for it to fully power off. Now walk the intended bore path while viewing the current frequency optimization in the frequency band you intend to drill with. Take note of the bar graph height in the selected band. With no transmitter on, this "signal strength" is in fact background noise (active interference). Extreme background noise (interference) may cause signal [attenuation](#).

In the following figure, the red flag area denotes an increase in noise detected on the optimized band while walking the intended bore path.

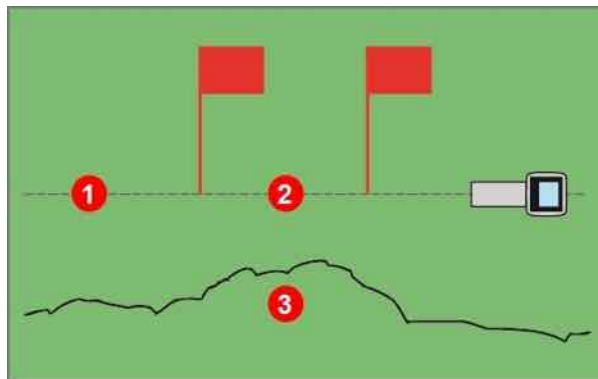

1. Intended bore path
2. Red flag area
3. Background noise signal

One-Person Background Signal Strength Check (Transmitter Off)

Return to the area of highest interference (between the red flags above) and note the signal strength on the Locate screen. Power on the transmitter and place it the same distance to the side of the receiver as the intended bore depth. Verify that the roll/pitch data is consistent and correct in the flagged area. The transmitter's signal strength should generally be a minimum of 150 points greater than the background noise reading. For example, if this area of greatest interference produced a reading of 175, the reading with the transmitter on at this location, and at a distance from the receiver equal to the maximum intended bore depth, should be a minimum of 325 ($175 + 150$).

Areas where the background noise level is too high may make it difficult to obtain roll and pitch data and accurate locates and depth readings. Conduct a roll/pitch check as described in the following section.

Note that the transmitter's signal strength will be slightly higher in this test than while drilling because it is currently not encased in the drill head below ground, which will diminish the signal strength slightly.



An **A** displayed at the bottom left of the roll indicator at distances greater than 8 ft. from the transmitter means signal [attenuation](#) is in effect, indicating the presence of excessive interference that can lead to inaccurate depth readings.

Roll/Pitch Check

At the exit of the bore, turn the receiver to face the entry and install batteries in the paired transmitter to turn it on. Have a coworker hold the transmitter and stand beside you. Walk together in parallel back toward the entry, keeping the receiver over the bore path and the transmitter at a distance of 1 to 1.5 times the current intended bore depth; where the bore is deeper, your coworker will be farther away. Periodically stop and change the transmitter's roll and pitch orientation so you can verify the speed and accuracy of these readings on the receiver. It is good practice to also have a coworker monitor the readings at the remote display at the same time. Note any locations where the receiver or remote display information becomes unstable or disappears. If roll/pitch data or signal strength become unstable, hold the trigger to see if Max Mode can stabilize the data.

[Max Mode](#)
Page 32

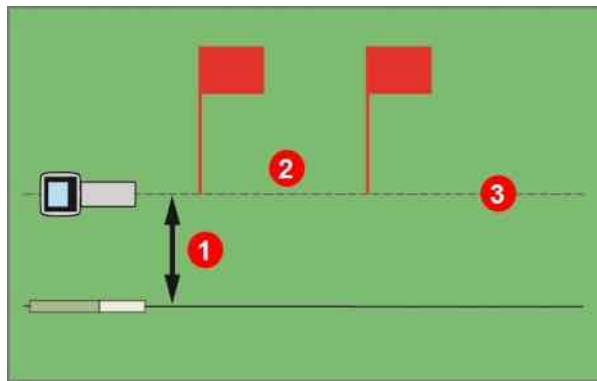

1. Intended depth
2. Red flag area
3. Intended bore path

Two-Person Roll/Pitch Test with Transmitter

If the desired depth/data range in a red flag area is not sufficient, you may be able to increase the range by performing another frequency optimization here and pairing to a new band specifically for use in this high-interference location. If you do this, check for interference in this area again using the newly-optimized band. Use the other optimized band (Up or Down) for the non-flagged portion of the bore.

Suggestions for Dealing with Interference

If roll/pitch information becomes unstable or is lost while drilling or during a roll/pitch check (see previous section), try one or more of the following:

- Try Max Mode.
- Move the receiver away from the interference source while staying within range of the transmitter.
- Physically separate the receiver from both passive and active interference to reduce or eliminate interference-related problems.
- Switch to the transmitter's other frequency band.
- To overcome interference at the remote display, ensure the telemetry antenna is vertical and that the front of the receiver is facing the remote display. Set the receiver and remote display to use a different telemetry channel. An optional extended-range telemetry antenna may help overcome some forms of interference.

[Max Mode](#)
Page 32

[Off-Track Locating](#)
Page 46

[Height-Above-Ground \(HAG\)](#)
Page 17

[Target Steering](#)
Page 48

[Changing Frequency Bands](#)
Page 59

Never rely on the receiver as the sole means of communication between the receiver operator and drill operator. In cases where data is not available on the remote display, both operators must be able to communicate with each other.



In environments with extreme interference, the signal strength on the receiver may begin to flash and **A** (Attenuation) will display at the bottom left of the roll indicator. This will also occur when the locator is too close to the transmitter (less than five feet). Do not rely on depth, data, or locate information obtained when the signal strength is flashing and the **A** icon is present.

Locate Points (FLP & RLP) and Locate Line (LL)

The Falcon receiver locates the transmitter by detecting three specific places in the transmitter's magnetic field: the front locate point (FLP) ahead of the transmitter, the rear locate point (RLP) behind the transmitter, and the locate line above the transmitter itself. The two locate points are indistinguishable from one another by the receiver as they represent similar points in the transmitter's field in front of and behind the transmitter (see [Appendix C](#) on page 66 for more information about the transmitter's magnetic field).

The locate line (LL) extends 90° to the left and right of the transmitter (perpendicular) when the transmitter is at 0% pitch. It represents the location of the transmitter between the FLP and RLP. If you think of the transmitter being the body of an airplane, its wings are the locate line.



Locate line does not equal the location of the transmitter.

Being over the locate line does not mean you are over the transmitter, which may be to the left or right anywhere along the locate line. You must find the front and rear locate points to find the transmitter, as is detailed on the next couple pages.

The most accurate tracking requires the use of all three locations to determine the position, heading, and depth of the transmitter. A line passing through the FLP and RLP reveals the heading and left/right position of the transmitter. The LL determines the position of the transmitter when the receiver is properly aligned between the FLP and RLP (on the line).

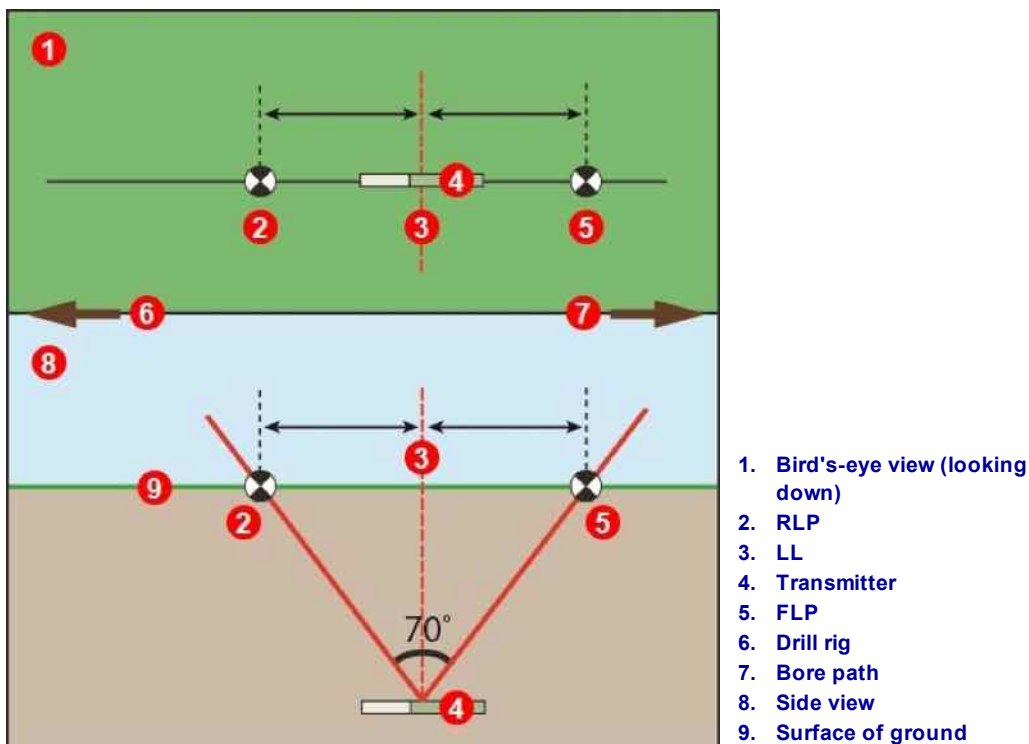

Geometry of FLP, RLP, and LL from Top (Bird's-Eye) and Side Views

Note how the RLP and FLP are equal distances from the LL when the transmitter is level.

The line marked LL in the bird's-eye view image suggests the receiver will display a locate line any time it is positioned on this plane. To prevent inaccurate locates and potentially dangerous conditions, it is imperative to first find the front and rear locate points. Do not rely on the peak signal along the locate line.



Whenever the transmitter is pitched, the position of the locate line will be somewhat slightly ahead of or behind the transmitter's actual position. This slight fore/aft offset will increase with depth (see [Appendix C](#)). In these cases, the depth displayed on the receiver is referred to as the projected depth.

Effects of Depth, Pitch, and Topography on Distance Between FLP and RLP

The deeper the transmitter is, the farther apart the FLP and RLP will be. The distance between the FLP and RLP with respect to the location of the LL is also affected by transmitter pitch and the topography.

When the transmitter pitch is negative, the FLP will be farther from the LL than the RLP. When the pitch is positive, the RLP will be further from the LL than the FLP. If the ground surface or topography slopes significantly, the locations of the FLP and RLP will also be affected with respect to the LL even if the transmitter itself is level.

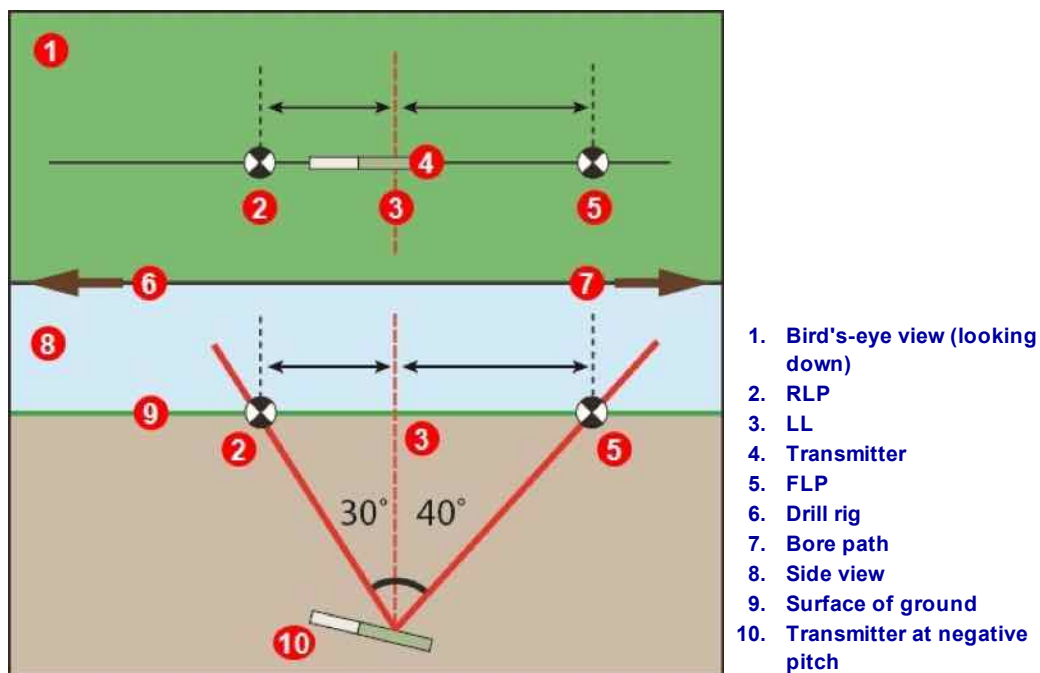

Effect of Pitch on Distance Between FLP, RLP, and LL

For a detailed explanation of how to track the transmitter when it is steep and deep, see [Appendix C](#) on page 66.

To calculate depth (for comparison to the receiver's depth reading) using the distance between the locate points and the pitch of the transmitter, see [Appendix D](#) on page 70.

Marking Locate Points

The locate points (FLP and RLP) and the locate line (LL) must be found and accurately marked during the locating procedure. To mark a locate point, stand with the receiver level at the locate point. Look down the vertical axis that runs through the center of the display to project a plumb line to the ground. Mark where this plumb line hits the ground.



1. Plumb line or vertical axis
2. Center of display
3. Front of receiver
4. Place marker straight down on ground

Plumb Line for Marking Locate Points

Locating the Transmitter

Falcon can locate the transmitter *and* its heading while it moves, whether in front of the transmitter, behind it, or beside it. It can locate the transmitter while facing toward or away from the drill rig.

The standard method described in this section guides the receiver to the transmitter while standing in front of it, facing the drill rig. This is the recommended method for locating. As you continue to drill or as the bore path curves, you may be facing the last marked locate point rather than the drill rig.

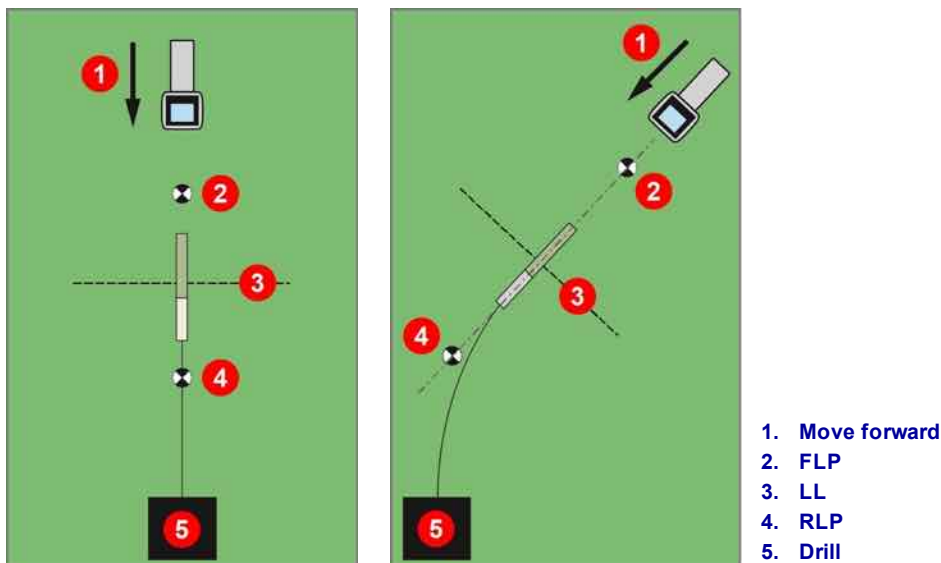

Standard and Curved Path Locating

If desired, set Height-Above-Ground (HAG) and Roll Offset.

[Height-Above-Ground \(HAG\)](#)
Page 17

[Roll Offset](#)
Page 24



Go watch some TV

You can find a training video on **Basic Locating** at www.youtube.com/dcikent.

Finding the Front Locate Point (FLP)

The locating procedure described here assumes that (a) you are facing the drill, (b) the transmitter is below ground and between you and the drill, and (c) the FLP is in front of you.

1. With the receiver on and in Locate mode, stand in front of the drill head at a distance of approximately the depth of the drill head.
2. Observe the position of the locating ball  relative to the receiver box on the display. The figures below show the FLP ahead of and to the left of the receiver; as the drill head gets deeper, the FLP will be found farther in front of the transmitter.

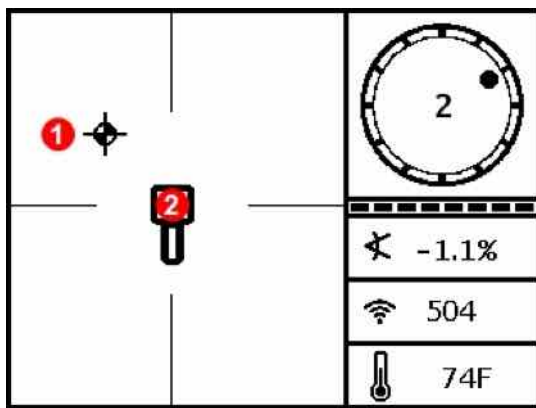

Receiver Locate Screen

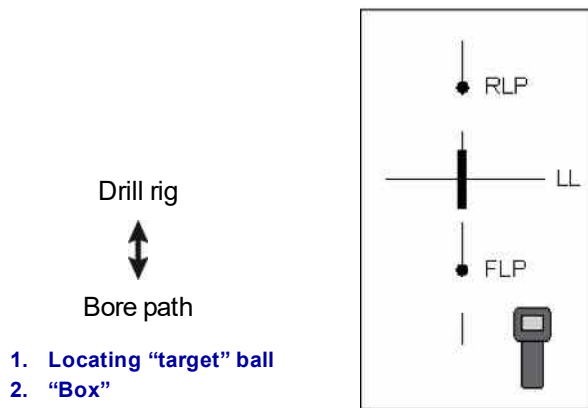

Actual Position of Receiver and Transmitter

3. Move the receiver to guide the ball into the box.
4. When the ball is centered in the box (*Ball-in-the-Box™*), hold the trigger for at least one second so the receiver can lock onto the reference signal. The **R** icon will appear at the top of the Depth screen. The locate line (LL) will not display later without this reference.

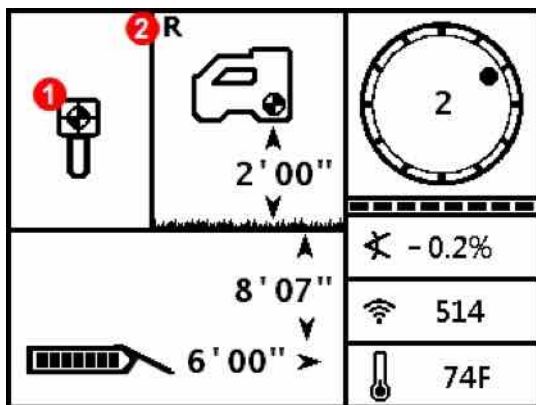

Receiver Predicted Depth Screen at FLP with HAG On

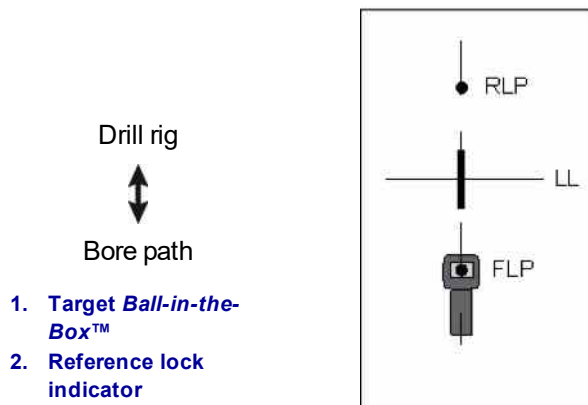

Actual Position of Receiver and Transmitter



When setting a reference signal, do not hold the trigger unless you are *Ball-in-the-Box*TM at the FLP. If you are ahead of the FLP, you could set an incorrect reference that causes a ghost locate line. This typically happens when the head is shallower than 3 ft. In this case, you must reference again at the FLP.

If you hold the trigger for longer than five seconds, the receiver will enter [Max Mode](#), which performs differently than a normal depth reading.

The depth value given at the FLP is the predicted depth, which is the depth the transmitter is calculated to be at when it reaches the location beneath the receiver. If the pitch or heading of the transmitter changes before it reaches the location under the receiver, the predicted depth reading will no longer be accurate.



Quick receiver self-test

To verify that the signal is balanced through the receiver's antenna, carefully rotate the receiver 360° about the center of the display while keeping the receiver level. The locating ball should stay centered in the box. If it does not, do not continue to use the receiver and contact DCI Customer Service.

- With the ball centered in the box, mark the ground directly below the receiver's display screen as the FLP.

Finding the Locate Line (LL)

- Continue walking toward the drill rig or the last known transmitter location. Keep the locating ball on the vertical crosshair and observe that the signal strength is increasing as you get closer to the transmitter.

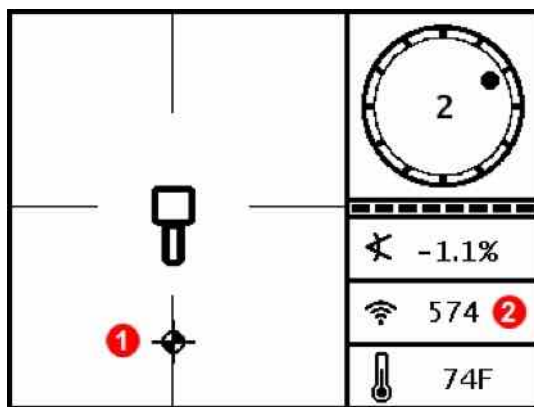

- Locating ball moving along vertical crosshair
- Signal strength higher than at FLP

Receiver Locate Screen, Moving Toward LL, FLP Behind

If the signal strength decreases, you may actually have just located the RLP. Position yourself farther away from the drill and start over at step 2.

- When the locating ball reaches the bottom of the screen, the locate line appears and the ball turns solid black to indicate your focus should now be on the LL.

If the locate line does not appear and the ball flips to the top of the screen, hold the trigger while moving the receiver in a forward/backward direction over where the ball flips. This action should re-reference the receiver to the transmitter's signal and bring up the locate line. If it does not, return to the FLP to re-reference (see step 1).

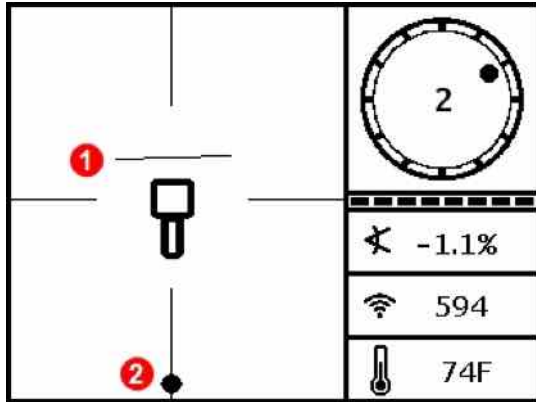

Receiver Locate Screen, Approaching LL

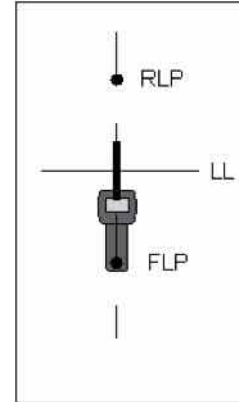
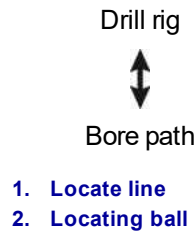

Actual Position of Receiver and Transmitter

Do not rely on the alignment of the ball with the vertical crosshair to identify the left/right position of the transmitter. Accurately locating the front and rear locate points is required to determine the transmitter's lateral position (heading) and take accurate depth readings.

- Position the receiver so the LL aligns with the horizontal crosshair.

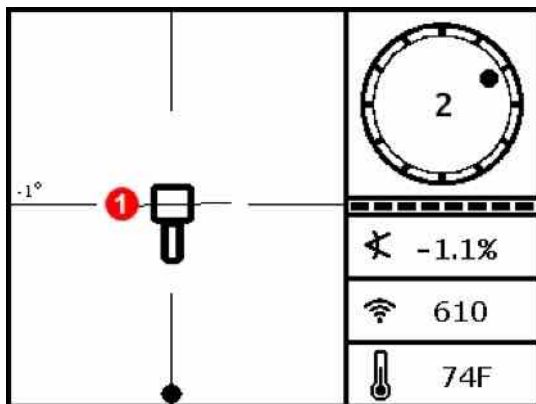

Receiver Locate Screen at the LL

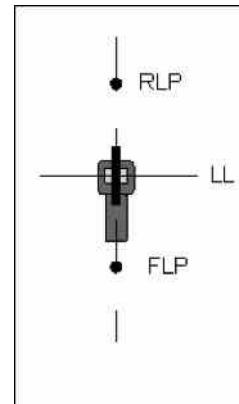
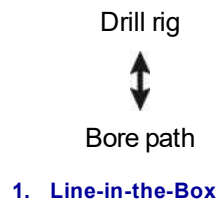

Actual Position of Receiver and Transmitter

- Take a depth reading and mark the LL directly below the receiver's display screen. If the FLP is to the left or right of the previous marks—indicating some steering action—locate the RLP as described in the next steps to verify proper positioning of the LL between the Locate Points.



If the bore path is straight, do I have to keep finding the RLP for every rod? Page 40

No. If a new FLP is directly in line with the previously marked FLPs (a straight bore line), it is unnecessary to find a new RLP since it will be directly in line with the previous marks. After the drill head moves forward another rod, find the new FLP and then the LL.

Finding the RLP to Confirm Transmitter Heading and Position

Finding the RLP will allow you to confirm the transmitter's heading and position. Like the FLP, the RLP is represented as a ball  on the receiver display.

Continue locating:

- From the LL, facing toward the drill or last transmitter location, walk forward while keeping the ball aligned on the vertical crosshairs. Notice how the signal strength decreases as you move away from the transmitter.

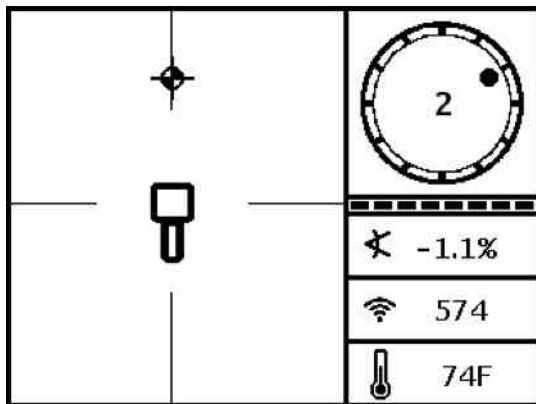

Receiver Locate Screen, Approaching RLP from LL

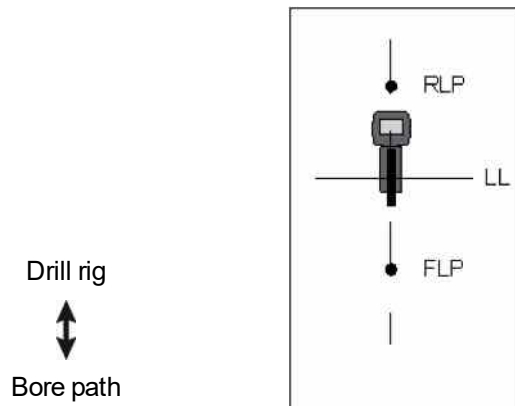

Actual Position of Receiver and Transmitter

- Position the receiver so the ball is centered in the box (*Ball-in-the-Box™*).

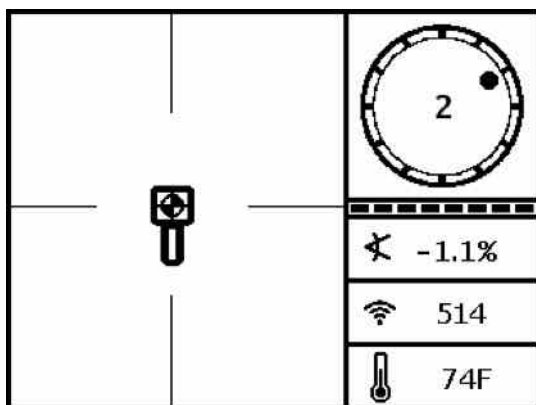

Receiver Locate Screen at RLP

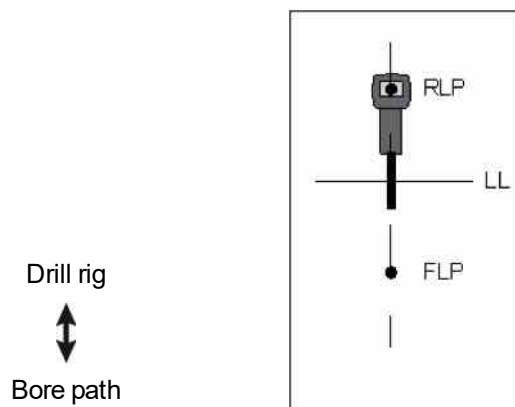

Actual Position of Receiver and Transmitter

- Mark the ground directly below the receiver's display screen as the RLP. A line between the RLP and FLP represents the transmitter's heading.

- Position the receiver at the intersection of this heading line with the LL passing through the center of the box on the display and hold the trigger to take a depth reading. This is the current location of the transmitter.

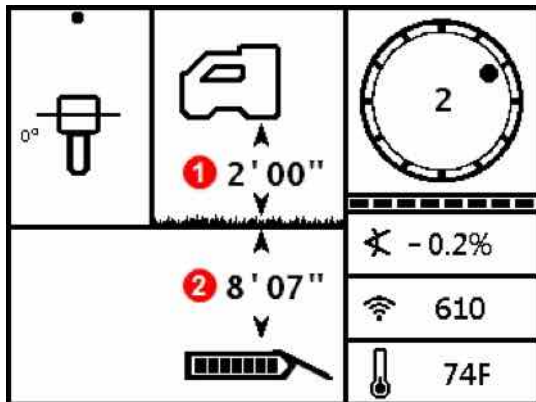

Receiver Depth Screen at LL

Drill rig
 ↑↓
 Bore path

- HAG on
- Corrected depth
- With LL aligned in box, receiver may face toward RLP or FLP during depth readings

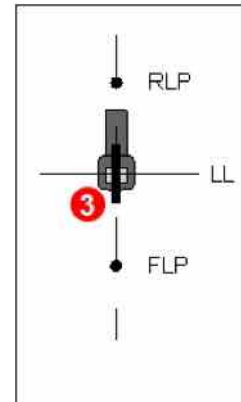

Actual Position of Receiver and Transmitter

Three Methods to Verify Depth Reading

Disable HAG, set the receiver on the ground, and take another depth reading. This reading should be within 5% of the depth reading obtained with the HAG on and the receiver lifted. In the prior example, the reading should be 8'7".

or

With HAG on, set the receiver on the ground and add the HAG to the depth shown. It should also be 8'7".

or

If HAG is not being used, note the depth on the ground and then raise the receiver exactly 3 feet. The depth reading should increase this same distance. In the example above, the depth would be 11'7".

See [Appendix C](#) on page 66 and [Appendix D](#) on page 70 for more information on depth.

Advanced Locating



When you're ready to be the expert

Here are some techniques that will help you drill more productively and get past the bore that had everyone else scratching their heads and calling the home office.

Tracking "On-the-Fly"



Go watch some TV

You can find a training video on **Tracking On-the-Fly** at www.youtube.com/dcikent.

If you are running at 0% (0°) pitch under level ground, the predicted depth will be the actual depth. In this case, all locating can be done at the FLP while the drill head is moving.

Once the transmitter has been located and it is moving in the correct direction, place the receiver relatively level on the ground one rod length in front of the FLP, in line with the path created by the FLP and RLP. Turn HAG off.

[Height-Above-Ground \(HAG\)](#)

Page 17

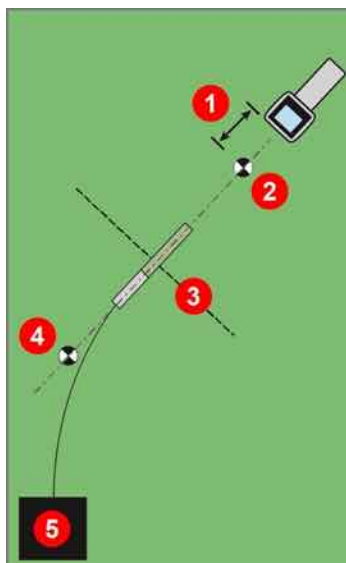
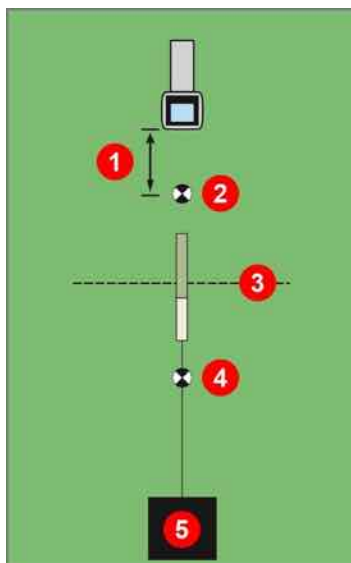

1. One rod length
2. FLP
3. LL
4. RLP
5. Drill

Tracking "On-the-Fly" with a Straight and Curved Path

As the drill head advances, the FLP should travel along the receiver's vertical crosshairs, indicating the drill head is still on line. Once the FLP is in the box, hold the trigger and confirm that the predicted depth reading is as expected.

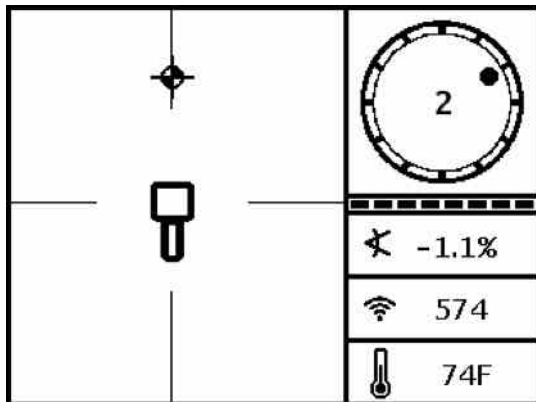

Receiver Screen Tracking "On-the-Fly"

Drill rig
 ↑↓
 Bore path

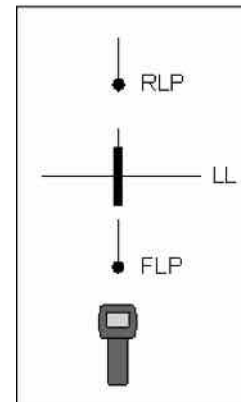

Actual Position of Receiver and Transmitter

Move ahead the length of another drill rod and wait for the FLP to continue advancing down the vertical crosshair.

Off-Track Locating



Go watch some TV

You can find a training video on **Off-Track Locating** at www.youtube.com/dcikent.

Use off-track locating when it is not possible to walk above the transmitter due to a surface obstruction or interference. Using the locate line's perpendicular relationship to the transmitter, it is possible to track the transmitter's heading and also determine if it is maintaining its intended depth. The off-track locating method is only effective when the pitch of the transmitter is 0% (0°) and traveling under flat ground.

To explain how the off-track locating method works, consider the example of an obstruction that is on the intended bore path, as shown in the figure below. The transmitter is about to go under the obstruction.

1. Stop drilling and find the locate line (LL) of the transmitter by putting the line in the box.
2. While holding the receiver in the same orientation, step to the side until you reach a predetermined distance (P1). Move the receiver forward and backward until the ball jumps between the top and bottom of the screen, then mark this location and note the signal strength. While still holding the receiver in the same orientation, do this two more times for off-track points P2 and P3.

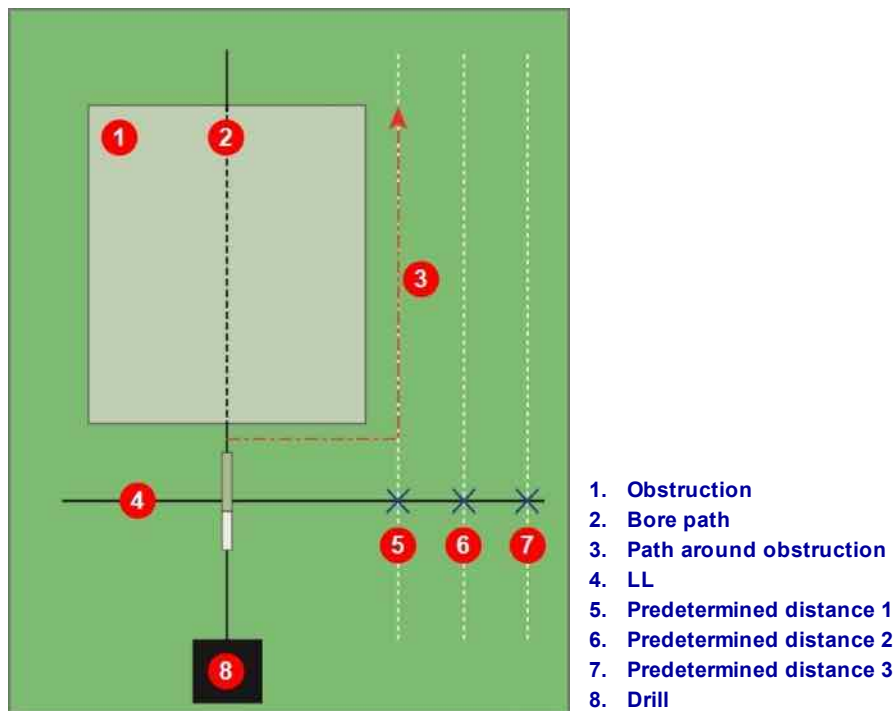

Preparing for Off-Track Locating

3. Connect points P1, P2, and P3 with a line. This is the locate line. Because the LL runs perpendicular (at a 90° angle) to the transmitter when the transmitter is level, you can determine the heading of the drill head. By comparing the signal strength at the predetermined distances of P1, P2, and P3 as the drill head progresses, you can verify it is moving away from or maintaining the intended bore path. It is important to monitor the pitch of the transmitter to ensure the drill head is maintaining the desired depth.
4. As drilling continues, steer the drill head to maintain a constant signal strength at each of the points P1, P2, and P3. If the signal strength decreases, the drill head is moving away (to the left in the image below); if it increases, the drill head is moving closer to the side position (to the right).

Differences in pitch and topology elevations will also affect the signal strength and LL position as the drill head progresses. Using three (or more) off-track points gives you more information to help recognize the potential adverse effects of interference at any one point.

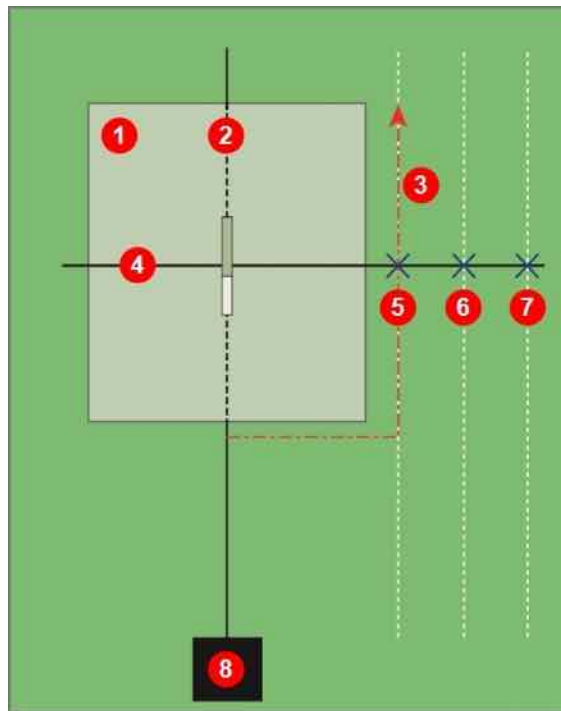

1. Obstruction
2. Bore path
3. Path around obstruction
4. LL
5. Predetermined distance 1
6. Predetermined distance 2
7. Predetermined distance 3
8. Drill

Off-Track Locating

Target Steering

The *Target Steering*[®] locating method allows the Falcon receiver to be placed ahead of the drill head and used as a steering target. It works especially well to avoid rebar that is causing signal interference, *if* the receiver can be placed beyond the rebar area.

In general, Target Steering should be used to *maintain* a bore path, not to correct a significantly off-course bore. If needed, use front and rear locate methods to get back on course.

[Locate Points \(FLP & RLP\) and Locate Line \(LL\)](#)

Page 37

In situations with significant pitch changes, such as during the entry/exit or areas with changing topography and elevations, the up/down steering information on the remote display may not be accurate. In these situations, only the left/right steering information should be considered accurate.



After learning the concepts of Target Steering, practice its use *before* using on a jobsite where time and money are at a premium. If you need further assistance, please contact DCI Customer Service.

The Falcon Compact Display supports Remote Steering, which provides left/right steering guidance but not depth. For Target Steering at the drill, DCI recommends the Aurora touchscreen remote display.



Go watch some TV

You can find a training animation on **Target Steering** at www.youtube.com/dcikent.

Using the receiver for Target Steering requires a stable signal from the transmitter.

Target Steering will not work properly with passive interference in the vicinity of the bore.

[Interference](#)
Page 33

Feasible Target Steering Area

The maximum distance the receiver can be placed ahead of the drill head for Target Steering is 35 ft. Beyond this distance, depth information becomes less accurate. Within this range, starting with the drill head approximately level, the following parameters apply to depth data:

- The maximum depth change is approximately 4 ft.
- The maximum pitch change is approximately 14%.

When used to provide only the right/left Remote Steering signals accepted by the Falcon Compact Display, the distance between receiver and transmitter is limited only by the range of the transmitter.

For the most conservative Target Steering operation, assume the ideal drill path is a circular arc with a radius that accommodates the bend radius of most drill strings and products being installed. As shown in the diagram below, the feasible steering area is limited to the shaded region bounded by the two circular arcs.

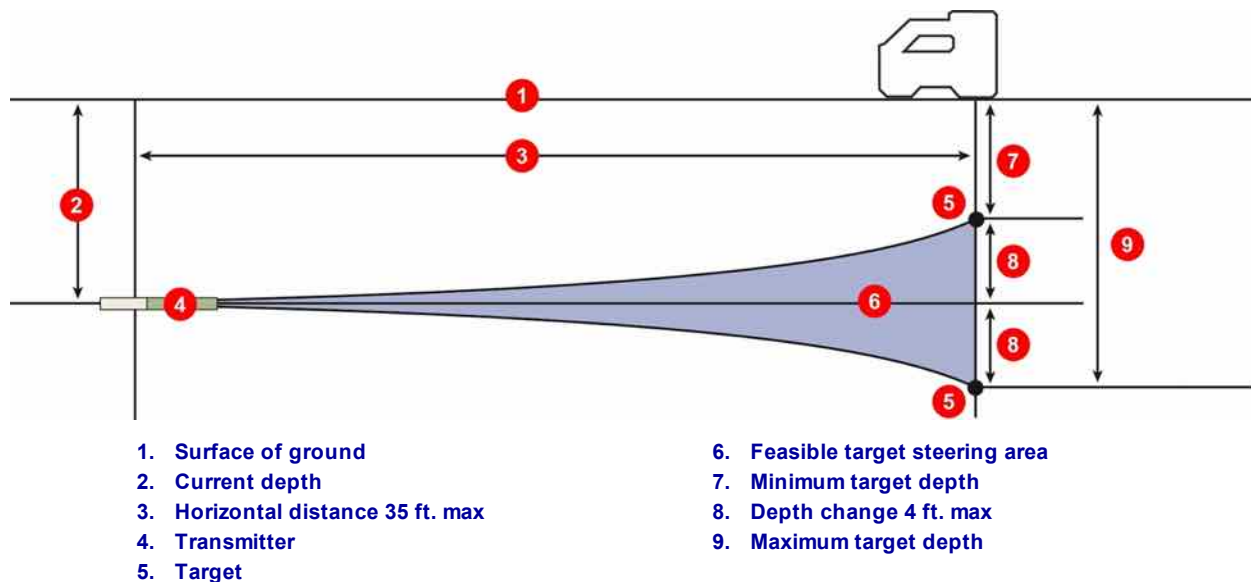

Feasible Target Steering Area

The Target Steering procedure requires correct placement of the receiver at less than 35 ft. in front of the transmitter, on the bore path, with its back end (where the battery pack is inserted) facing the drill.

Use the three screens in the Target Steering menu  on the receiver to turn Target Steering On, turn Target Steering off, or set the target depth, as described in the following sections.

Turning Target Steering On and Off

Turn TS On

Use the first screen in the Target Steering (TS) menu to turn remote steering on at the target depth displayed, which is either the default value of 2 ft. or the most recently-set value. The target depth is the depth at which you want the transmitter when it passes under the receiver. To change the target depth, click twice and skip to [Setting the Target Depth](#) on page 51.

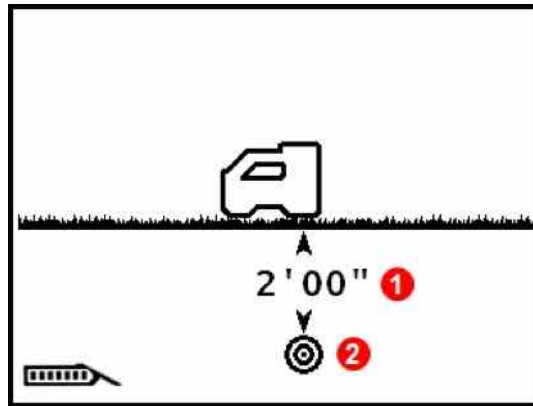

1. Programmed target depth
2. Indicates a programmed target depth

Target Steering Menu

Hold the trigger briefly to turn Target Steering on with the displayed depth value. A check mark appears briefly next to the receiver icon. The receiver beeps four times to confirm and returns to the Locate screen with Target Steering enabled.

With Target Steering enabled, the Locate screen will now show the horizontal distance from transmitter to receiver (see the first screen in the section [Positioning the Receiver as the Target](#) on page 52).

Any HAG setting in effect is ignored during Target Steering.

Turn TS Off

Use the second screen in the Target Steering menu to turn target steering off.

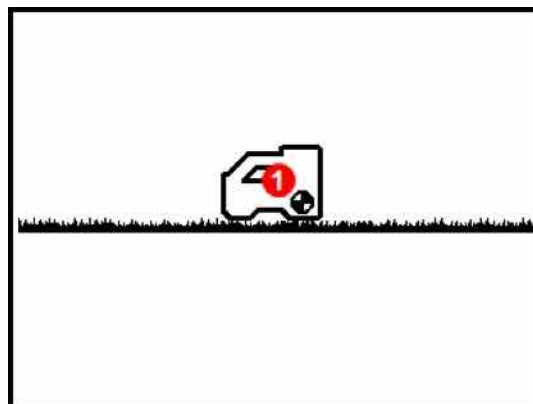

1. Locating target represents no target depth programmed

Turning Target Steering Off

Hold the trigger briefly to turn Target Steering off. A check mark appears briefly next to the receiver icon. The receiver beeps four times to confirm and returns to the Locate screen.

When the receiver exits Target Steering mode, the remote display automatically returns to the normal Remote Locating screen and the receiver no longer displays horizontal distance from transmitter to receiver.

Setting the Target Depth

Use the third screen in the Target Steering menu to set the target depth. This screen is similar to the first screen except that a question mark appears in place of the current target depth value.

1. Hold the trigger briefly to set the target depth value.

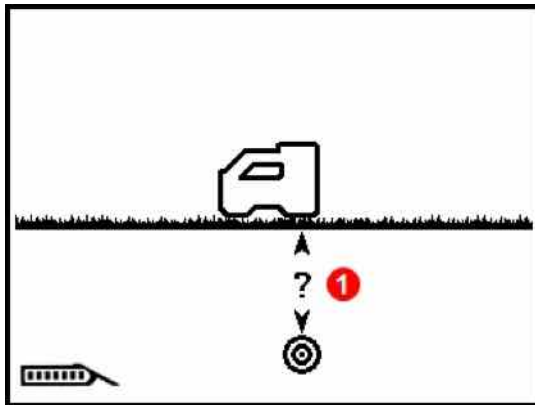

1. Select to set target depth

2. The first digit is underlined. Click to select the next digit, or hold briefly to change the value.

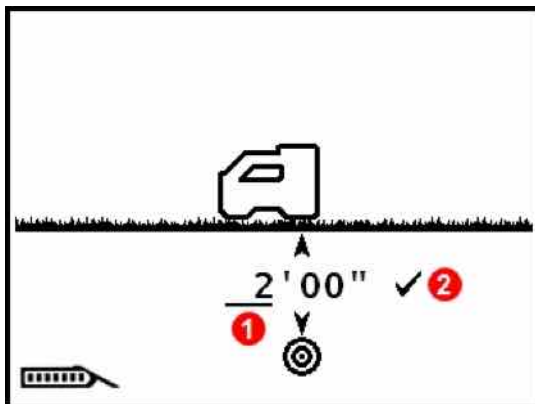

1. Current selection
2. Select to confirm setting

3. Upon selection, the value becomes boxed. Click to scroll through numeric values, then hold briefly to select. Click to select subsequent values and hold briefly to change.
4. When the target depth is set correctly, select the check mark to confirm. A check mark appears briefly next to the receiver icon and the receiver beeps and returns to the Locate screen with Target Steering enabled.

If you click past your desired foot value, either click through the maximum value of 99 ft. or wait about five seconds to exit without saving and try again.

If you click past 11 in. in the inches field, the number in the *ft.* field will automatically increase.

To maintain the most accurate readings on the remote display, never set the target steering depth more than 3 ft. from the current depth.

Positioning the Receiver as the Target

Setting a target depth on the receiver activates target steering, and the Locate screen on the receiver now displays horizontal distance from transmitter to receiver. The remote display on the drill automatically changes to Target Steering or Remote Steering mode.

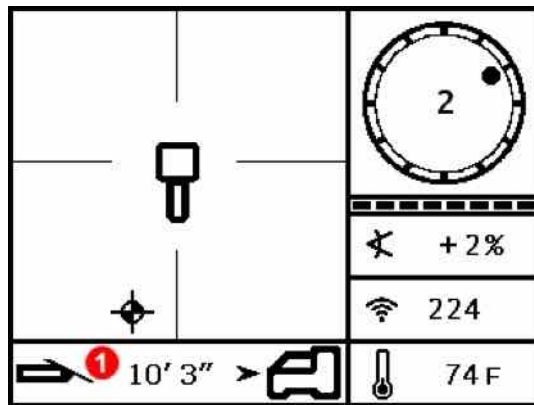

1. Horizontal distance from transmitter to receiver

Remote Steering Data on the Receiver

Ensure that the location you would like to steer to beneath the receiver is feasible for the bend radius of the drill string and product being installed.

[Feasible Target Steering Area](#)

Page 49

Place the receiver on the intended drill path beyond the FLP but within 35 ft. of the transmitter with its back end (battery pack) facing the transmitter's current location. Position the receiver with the understanding that Target Steering is designed to ensure the transmitter is perpendicular to the rear of the receiver by the time the drill head reaches the target beneath the receiver.

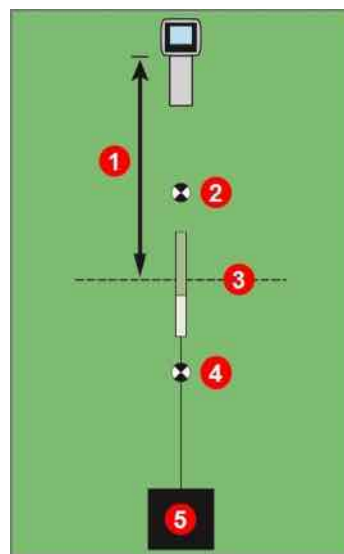

1. 35 ft. max
2. FLP
3. LL
4. RLP
5. Drill

Positioning the Receiver for Target Steering

For the Falcon remote display that supports only Remote Steering, the 35 ft. maximum distance from the transmitter shown below is instead limited only to the maximum range of the transmitter.

Steering to the Target with the Remote Display

Refer to the operator's manual for your remote display for details on its Target Steering or Remote Steering screen. Manuals are located on the flash drive that accompanied the equipment or online at www.DigiTrak.com.

Target Steering in Interference Areas



Interference can cause inaccuracies in the measurement of depth and placement of the locating ball, and loss of the transmitter's pitch, roll, or heading.

In areas of passive and/or active interference, it may help to physically elevate the receiver above the ground. If raising the receiver above the ground, adjust the target depth to include the elevated height.

Transmitter

This section describes the 15-inch Falcon transmitter for your system. For a list of other compatible transmitters, see the table under [Transmitter Drill Head Requirements](#) on page 57. For information on using a DucTrak transmitter, please visit our website at www.DigiTrak.com.

A transmitter generates a magnetic field detected by the Falcon receiver. The transmitter and receiver must have matching regional designation numbers to communicate with each other and comply with local operating requirements. The transmitter's regional designation number is located inside the globe icon  near the serial number. The transmitter must be paired to the receiver prior to use.

The standard Falcon F2 wideband transmitter measures 15 in. long and 1.25 in. in diameter, provides pitch readings in as low as 0.1% or 0.1° increments at level, and displays roll in 12 clock positions (CP). The transmitter broadcasts in nine bands encompassing frequencies from 4.5 to 45.0 kHz.



1. Battery compartment
2. Infrared (IR) port
3. Front end cap with temp dot and index slot

Falcon F2 Wideband 15-inch Transmitter

Calibration is required prior to first-time use and before using a different transmitter, receiver, drill head, or optimized transmitter band. Calibration is not necessary, however, when switching between bands on a transmitter that are already paired and calibrated.

[Calibration and AGR](#)

Page 19

A detailed pitch resolution table is located in [Appendix A](#).



Can I use other DigiTrak transmitters with my Falcon?

No. The technology behind Falcon's use of multiple optimized frequencies requires a DigiTrak Falcon F2 wideband or DucTrak transmitter.

Can I use DigiTrak transmitters rebuilt by other companies?

DCI recommends avoiding the use of "repaired" or "rebuilt" transmitters for any reason. Untrained technicians, poor quality of workmanship, and the re-use of stressed electronic components introduces unnecessary risk to your project that far outweighs any perceived short-term cost savings. DigiTrak Falcon transmitters incorporate recent advances in architecture and durability that provide an even longer expected lifetime under typical conditions.

Batteries and Power On/Off

15-inch Transmitters

DigiTrak Falcon 15-inch wideband transmitters require two C-cell alkaline batteries or one DCI SuperCell™ lithium battery providing a maximum of 3.6 VDC. Alkaline batteries will last up to 20 hours, whereas a SuperCell battery will last up to 70 hours.

8-inch Transmitters

DigiTrak Falcon 8-inch wideband transmitters require a single lithium 123 3V battery. Insert the positive end first. This battery will last up to 12 hours.



Never use damaged or non-DCI lithium batteries. Never use two C-cell lithium batteries providing a combined voltage above 3.6 VDC.

DCI SuperCell lithium batteries are manufactured to military specifications. The use of damaged or lower-quality lithium batteries may damage the transmitter and/or housing and will void the DCI warranty.

Installing Batteries / Power On (15-inch)

DCI transmitters power on as soon as the batteries and battery cap are properly installed. To install the batteries:

1. Remove the battery cap from the transmitter using a large slotted screwdriver or coin and rotating counterclockwise.
2. Insert the battery or batteries into the transmitter with the positive terminals first. When using two C-cell batteries, include the battery contact spring that came with the transmitter as shown below:

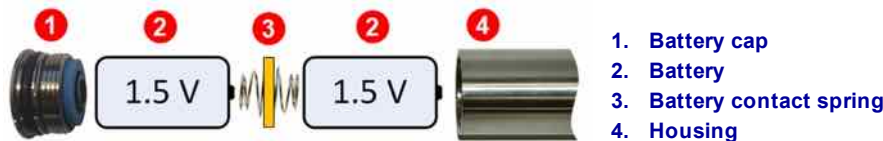

C-Cell Batteries Installed with Battery Contact Spring

Do NOT use the battery contact spring at either end of a single SuperCell™ battery.

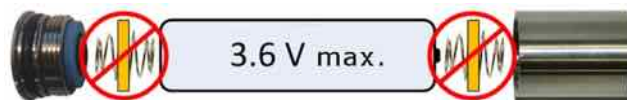

Falcon transmitters should be held by the stainless steel battery compartment tube while installing or removing the battery cap. Holding the green fiberglass tube could potentially damage the seal between the two sections.

- Select the startup frequency of the transmitter by installing the batteries with the transmitter pointing either up or down:

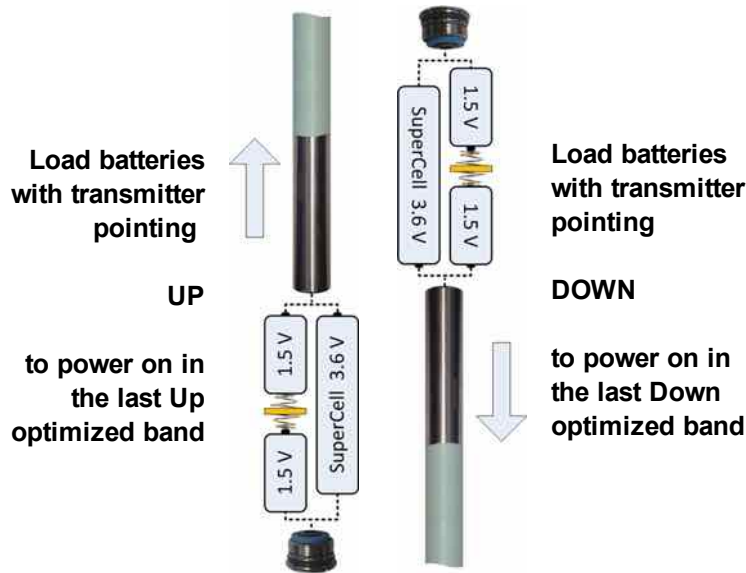

Selecting the Startup Frequency of the Transmitter

To power on the transmitter in the last band used, install the batteries with the transmitter horizontal.

- Replace the battery cap and maintain orientation for at least 10 seconds. Do not overtighten the cap.



Starting the **Frequency Optimizer** will not change the transmitter's optimized frequency bands until the receiver and transmitter are paired. Once paired, the transmitter automatically begins using the new optimized frequency band. With two new bands, the system defaults to using the Down band first.

Transmitter Battery Strength

The battery strength icon  at the bottom of the receiver's Depth screen indicates the battery life remaining for alkaline batteries. It also appears at the bottom left of the Locate screen for the first five minutes the transmitter is powered on. Until the transmitter is installed in a housing and therefore drawing normal current, this strength reading will not be accurate.



Because the battery strength for a lithium battery (SuperCell and 123) will appear full until just before it is depleted, you must track its hours of use.

Transmitter Current Draw Warning

Transmitter over-current—drawing too much current from the batteries, which shortens battery life—may occur due to weak or used batteries or use of an incompatible drill housing. Excessive current is indicated by a lightning bolt over the transmitter battery strength icon on the Locate screen.



The Falcon transmitter only performs this current draw test for five minutes after powering on. The transmitter must be installed in the drill head for this test to be valid. Different drill heads and slot arrangements will affect current draw and battery life.

This feature does not work with 8-inch transmitters.

Sleep Mode

All battery-powered DigiTrak transmitters go into sleep mode and stop transmitting to conserve battery power if they are stationary for longer than 15 minutes. To wake the transmitter, rotate the drill string a half turn; a transmitter will not awake if it lands on the same roll position at which it went to sleep.

A small amount of charge will continue to drain from the batteries while the transmitter is in sleep mode so it can monitor roll position. To conserve battery life, do not leave batteries in the transmitter when they can be easily removed. Always remove batteries when the transmitter is not being used to turn it off.

Sleep time does not count towards the hours-based warranty runtime.



A transmitter will continue sending data for up to 10 seconds after the batteries are removed. If you have removed the batteries and intend to restart the transmitter in another frequency, wait until data has stopped displaying on the receiver before reinstalling the batteries.

DucTrak transmitters do not use sleep mode.

Transmitter Drill Head Requirements

For maximum transmitter range and battery life, the slots in the drill head must meet minimum length and width requirements and be correctly positioned. DCI's transmitters require a minimum of three slots equally spaced around the circumference of the drill head for optimal signal emission and maximum battery life. Measure slot lengths on the *inside* of the drill head; slots must be at least $\frac{1}{16}$ in. wide. DCI transmitters fit standard housings but may require a battery cap adapter in some cases.

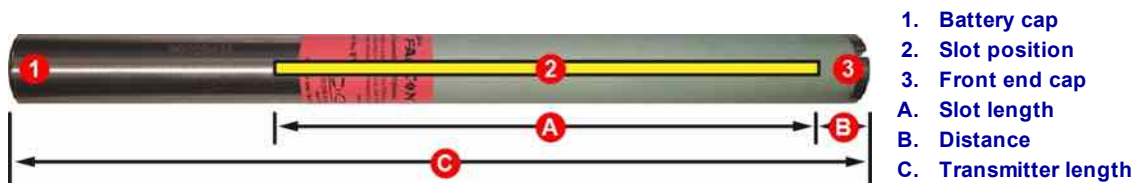

	A Minimum	B Maximum	C
Falcon F2 15-inch transmitter	9.0"*	1.0"*	15"
Falcon F2 8-inch transmitter	4.0"	1.0"	8"
* Ideal measurement. The DCI standard slot length of 8.5" (A) and distance of 2.0" (B) remain acceptable.			

A transmitter must fit snugly in its drill head. It may be necessary to wrap the transmitter with tape or O-rings and/or use a drill head adapter for larger drill heads. Contact DCI Customer Service for more information.

The index slot in the front end cap of the transmitter should fit onto the anti-roll pin (key) in the drill head for proper alignment. Use roll offset if the transmitter's 12:00 position does not match that of the drill head.

[Roll Offset Menu](#)
Page 24

Use only the battery cap that accompanied the Falcon transmitter; other battery caps may look similar but crush the batteries or make the transmitter too long to fit in a standard housing.

Temperature Status and Overheat Indicator

Most DigiTrak transmitters are equipped with an internal digital thermometer. The temperature displays on the bottom right of the receiver and remote display screens next to the transmitter temperature symbol . Normal drilling temperatures range from 64 to 104° F. Suspend drilling when temperatures exceed 97° F to permit cooling.





Because the digital thermometer is inside the transmitter, temperature increases due to external drilling conditions will take time to transfer to the transmitter. Resolve increases in temperature quickly to avoid irreversible damage.

If the temperature reaches 118° F, the thermometer icon will change to show that the transmitter is becoming dangerously hot . The transmitter must be allowed to cool immediately or it will be damaged.

To cool the transmitter, stop drilling and retract the drill a few feet and/or add more drilling fluid.

Transmitter Temperature Warning Tones

The Falcon receiver and remote display emit the following audible tones to indicate increases in the transmitter temperature:

Icon	Temperature	Warning Tones
	Below 61° F	None
	61 – 97° F	Double-beep sequence (beep-beep) for every 7° F increase in temperature.
 <i>flashing</i>	104 – 111° F	Two double-beep sequences (beep-beep, beep-beep) for every 7° F increase in temperature. Action is required to cool the transmitter.
	118 – 133° F	Three double-beep sequences (beep-beep, beep-beep, beep-beep) for every 7° F increase in temperature. Cooling is critical to avoid irreversible damage.
 <i>flashing</i>	140° F or above	Three double-beep sequences every 5 seconds on the remote display, and every 20 seconds on the receiver. This warning signifies dangerous drilling conditions; irreversible damage may have already been done to the transmitter.
	220° F	15-inch – None: transmitter overheat indicator (temp dot) turns black.
	180° F	8-inch – None: transmitter overheat indicator (temp dot) turns black.

Transmitter Overheat Indicator (Temp Dot)

Most DigiTrak transmitters have a temperature overheat indicator (temp dot) on the front end cap. The temp dot has an outer yellow ring with a $\frac{1}{8}$ in. white dot in the center.

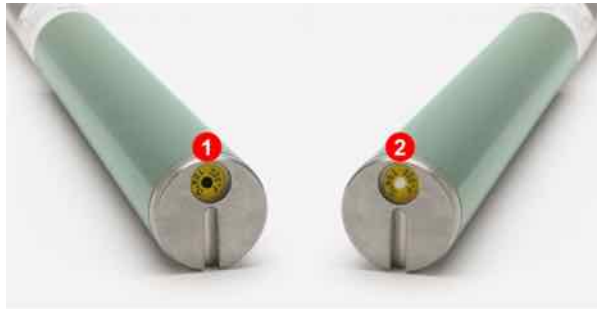

1. Black temp dot voids warranty
2. Normal temp dot

Transmitter Temp Dot

If the temp dot changes to silver or gray, the transmitter has been exposed to heat but not in excess of specifications. If the temp dot is black, the transmitter has been exposed to excessive temperatures and can no longer be used. The DCI warranty does not cover any transmitter that has been overheated (black dot) or had its temp dot removed.

Avoid transmitter overheating by practicing proper drilling techniques. Abrasive soils, clogged jets, inadequate mud flow, and improperly mixed mud all contribute significantly to the overheating of a transmitter.

The Falcon transmitter stores the maximum temperature, which you can view using the Transmitter Info function. Note that the external temp dot can overheat and turn black before the *internal* temperature reaches the maximum allowed.

[Transmitter Information](#)

Page 25

Transmitter Warranty Timer

The timer used for the transmitter hours-based warranty is viewable under [Transmitter Information](#) on page 26.

Runtime hours accrue whenever the transmitter is sending data; they do not accrue when the transmitter is in Sleep mode. The 3-year/500-hour warranty requires that the transmitter be registered at access.DigiTrak.com within 90 days of purchase. See the warranty at the end of this manual for additional information.

Changing Frequency Bands

Use these procedures to switch between the two optimized frequency bands, such as when performing an [interference check](#) (page 34), or an [AGR test](#) (page 22) in both bands with the transmitter in the drill head prior to drilling. Both optimized bands remain stored on both the receiver and transmitter even after a power cycle.

[Batteries and Power](#)

[On/Off](#)

Page 55

Above Ground (Pre-Bore) Tilt Method

Do not roll the transmitter more than two clock positions (CP) during this procedure.

1. Place the transmitter on an approximately level surface ($0\pm 10^\circ$) for at least five seconds with the receiver at the Locate screen and transmitter data being displayed.
2. Tilt the transmitter up at approximately 65° (over 100%, or nearly vertical).
3. Hold the transmitter steady for 10–18 seconds.
4. Return the transmitter to level within 10 seconds.
5. After 10–18 seconds, all transmitter data disappears from the receiver's screen, indicating the transmitter frequency has changed.
6. Select the new frequency band in the receiver's Transmitter Options menu. The new band displays at the top of the Main menu. It may take up to 30 seconds for the transmitter to begin sending data on the new frequency; return to the Locate screen and verify that transmitter data appears on the display.



[Transmitter Options Menu](#)
Page 25

Below Ground (Mid-Bore) Roll Methods

Switching between bands on the Falcon F2 transmitter may provide better data results while drilling in a section of the bore with a high level of interference. Use these methods to switch between transmitter frequency bands mid-bore. Practice these roll methods *before* sending the drill head below ground.

Frequency Change, 10-2-7

1. Ensure roll offset is disabled and transmitter roll data is displayed on the receiver.
2. Position the transmitter at 10:00 (± 1 clock position, or CP) for 10–18 seconds.
3. Roll the transmitter clockwise to its 2:00 position (± 1 CP) within 10 seconds and remain there for 10–18 seconds.
4. Roll the transmitter clockwise to its 7:00 position (± 1 CP) within 10 seconds.
5. When transmitter data disappears from the receiver, the transmitter frequency has changed. This will take approximately 10–18 seconds.
6. Select the new frequency band in the receiver's Transmitter Options menu. The new band displays at the top of the Main menu. It may take up to 30 seconds for the transmitter to begin sending data on the new frequency; return to the Locate screen and verify that transmitter data appears on the display.

[Roll Offset Menu](#)
Page 24

[Transmitter Options Menu](#)
Page 25

7. Re-enable roll offset, if applicable.

Frequency Change, Repeating Roll Sequence (RRS3)

1. Remain at any clock position (CP) for at least 40 seconds to clear all timers.
2. Make a reference mark on the drill string.
3. Complete one full clockwise rotation (± 2 CP) of the reference mark within 0.5–30 sec., then wait 10–20 seconds.
4. Repeat step 3 two more times, for a total of three rotations (RRS3).
5. After the third rotation, leave the drill string at rest for a total of 60 seconds, after which the transmitter changes frequency.

6. Select the new frequency band in the receiver's Transmitter Options menu. The new band displays at the top of the Main menu. It may take up to 30 seconds for the transmitter to begin sending data on the new frequency; return to the Locate screen and verify that transmitter data appears on the display.

[Transmitter Options](#)

[Menu](#)

Page 25









If any rotation is not completed within the prescribed time, or if any rotation continues for more than one full revolution, the transmitter frequency change is canceled.



A warning symbol  in the roll indicator after changing bands on the receiver means the transmitter has not yet been [calibrated](#) in this band. While locate positions and roll/pitch data will be correct, depth readings will be incorrect.

Appendix A: System Specifications

Power Requirements

Device (Model Number)	Operational Voltage	Operational Current
DigiTrak Falcon F2 (FAR2)	14.4 V 	300 mA max
DigiTrak SE NiMH Battery Charger (SBC)	Input 100 – 240 VAC Output 25 V  (nominal)	350 mA max 700 mA max
DigiTrak SE NiMH Battery Pack (SBP)	14.4 V  (nominal)	2.0 Ah 29 Wh max
DigiTrak F Series Battery Charger (FBC)	Input 10 – 28 V  Output 19.2 V 	5.0 A max 1.8 A max
DigiTrak F Series Lithium-Ion Battery Pack (FBP)	14.4 V  (nominal)	4.5 Ah 65 Wh max
DigiTrak Transmitter (BTW)	1.2 – 4.2 V 	1.75 A max
DigiTrak Transmitter (BTS)	1.2 – 4.2 V 	0.4 A max

Environmental Requirements

Device	Relative Humidity	Operating Temperature
DigiTrak Falcon F2 Receiver (FAR2) and Falcon Compact Display (FCD) with NiMH Battery Pack with Lithium Battery Pack	<90%	14 – 149 °F -4 – 140 °F
DigiTrak Aurora Remote Display (AF8/AF10)	<90%	-4 – 140 °F
DigiTrak Transmitter (BTW)	<100%	-4 – 220 °F
DigiTrak Transmitter (BTS)	<100%	-4 – 180 °F
DigiTrak SE NiMH Battery Charger (SBC)	<90%	32 – 104 °F
DigiTrak SE NiMH Battery Pack (SBP)	<99%, <50 °F <95%, 50 – 95 °F <75%, 95 – 149 °F	14 – 149 °F
DigiTrak F Series Battery Charger (FBC)	<99%, 32 – 50 °F <95%, 50 – 95 °F	32 – 95 °F
DigiTrak F Series Lithium-Ion Battery Pack (FBP)	<99%, <50 °F <95%, 50 – 95 °F <75%, 95 – 140 °F	-4 – 140 °F

System working altitude: rated up to 6561 ft.

Storage and Shipping Requirements

Temperature

Storage and transportation temperature must remain within -40 – 149 °F.

Packaging

Ship in original carrying case or packaging of sufficient durability to prevent mechanical shock to equipment during transportation.

Approved for transportation by vehicle, boat, and aircraft.

SuperCell batteries are regulated UN3090 lithium metal batteries and F Series FBP batteries are regulated UN3480 and UN3481 lithium-ion batteries. Lithium batteries are considered Class 9 Miscellaneous Dangerous Goods under International Air Transportation Association (IATA) regulations; IATA regulation and Ground Transportation regulations 49 CFR 172 and 174 apply. These batteries must be packaged and shipped by trained and certified personnel only. Never ship damaged batteries.

Equipment and Battery Disposal



This symbol on equipment indicates that the equipment must not be disposed of with your other household waste. Instead, it is your responsibility to dispose of such equipment at a designated collection point for the recycling of batteries or electrical and electronic equipment. If the equipment contains a banned substance, the label will show the pollutant (Cd = Cadmium; Hg = Mercury; Pb = Lead) near this symbol. Before recycling, ensure batteries are discharged or the terminals are covered with adhesive tape to prevent shorting. The separate collection and recycling of your waste equipment at the time of disposal will help conserve natural resources and ensure it is recycled in a manner that protects human health and the environment. For more information about where you can drop off your waste equipment for recycling, please contact your local city office, your household waste disposal service, or the shop where you purchased the equipment.













U.S.: Contact the Rechargeable Battery Recycling Corporation's (RBRC) Battery Recycling Program at 800.8.BATTERY or visit www.rbrc.org to recycle your used battery.







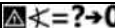



Transmitter Pitch Resolution

Transmitter pitch resolution decreases with increased grade.

±% Grade	± Degrees Grade	% Resolution
0 – 3%	0 – 1.7°	0.1%
3 – 9%	1.7 – 5.1°	0.2%
9 – 30%	5.1 – 16.7°	0.5%
30 – 50%	16.7 – 26.6°	2.0%
50 – 90%	26.6 – 42.0°	5.0%

Appendix B: Receiver Screen Symbols

Symbol	Description
A	Attenuated Signal – Indicates signal attenuation is in effect due to the presence of excessive interference, or when locating within 3 ft. of the transmitter. The receiver automatically attenuates the transmitter signal when locating at shallow depths to reduce excessive signal strength. The A displays at the bottom left of the frequency optimizer results (page 14) or at the bottom left of the roll indicator (page 31) on the locate screen. Attenuation while locating in close proximity to the transmitter is normal; attenuation during calibration or frequency optimization is a warning to relocate to a location with less interference. The receiver will not calibrate when the signal strength is flashing, indicating the presence of extreme interference. <i>Page 19</i>
	Calibration Signal High – Displays after a failed calibration, often because the transmitter is too close to the receiver. <i>Page 22</i>
	Calibration Signal Low – Displays after a failed calibration, often because the transmitter is not powered on or is on a different (Up or Down) frequency band than the receiver. <i>Page 22</i>
	Calibration Attenuation Error – Displays after a failed calibration. If attenuation is in effect due to only moderate interference, the system will still calibrate; however, it is best practice to relocate to a quieter location where attenuation is not in effect. If the signal strength on the locate screen is flashing, this indicates extreme interference, and a calibration will fail. <i>Page 20</i>
	Globe Icon – Shown on the receiver startup screen, the number inside (shown blank here) identifies the regional designation, which must match that on the transmitter battery compartment. <i>Page 6</i>
	Ground Level – Represents the ground for the HAG function and depth readings. <i>Page 31</i>
	Locate Line – The locate line (LL) always displays perpendicular to the transmitter. The locate line (LL) is found between the front and rear locate points only after a reference lock (see below) has been obtained. May also include the transmitter yaw angle in degrees. <i>Page 31</i>
	Locating Ball/Target – Represents the front and rear locate points (FLP and RLP). When the locate line appears, the locating ball will become a solid circle (ball) representing the approximate locate point. <i>Page 30</i>
	Locating Icon (the receiver) – Represents a bird's-eye view of the receiver. The square at the top of this icon is referred to as the "box" in the terms <i>Ball-in-the-Box™</i> and <i>Line-in-the-Box</i> locating. <i>Page 30</i>
	Max Mode – Max Mode begins when the trigger is held longer than five seconds during a depth reading. <i>Page 32</i>
	Max Mode Timer – Provides a visual indication that Max Mode is active (trigger held). Replaces the roll/pitch update meter. <i>Page 32</i>
	Pitch Assumed Zero – Indicates that since no pitch data is currently available, the pitch is assumed to be zero for depth, predicted depth, and AGR calculations. <i>Page 30</i>
	Receiver Battery Strength – Shows the remaining battery life of the receiver. Appears above the main menu. When battery life is low, the icon will flash on the Locate screen. <i>Page 12</i>
	Receiver Icon – Indicates the position of the receiver relative to the ground for the HAG function, depth readings, and the Target Steering function. <i>Page 31</i>
R	Reference Lock – Indicates a reference signal has been obtained for displaying the locate line. Displays at the top of the Locate screen. <i>Page 40</i>
RO	Roll Offset – Indicates roll offset is enabled. Displays at the bottom right of the roll indicator. <i>Page 24</i>

Symbol	Description
	Roll/Pitch Update Meter – Shows the quality of data reception from the transmitter (specifically, data rate). A full bar is the best signal. A shorter bar indicates the receiver is in an area of interference or you are reaching the range limit of the transmitter, relative to interference. <i>Page 30</i>
	Transmitter Battery Strength/Drill Head – Depicts the remaining battery life of the transmitter when alkaline batteries are used. Also represents the position of the drill head relative to the receiver in the Depth screen. Appears for five minutes at the bottom left of the Locate screen and also on depth screens. <i>Page 31</i>
	Telemetry Channel – The channel used to communicate with the remote display on the drill rig. Select whichever channel offers the best performance. Select channel 0 to turn telemetry off. <i>Page 27</i>
	Transmitter Current Draw Warning – Indicates transmitter over-current, perhaps due to weak batteries or use of an incompatible drill housing. <i>Page 31</i>
	Transmitter Pitch – The number next to this icon on the Locate screen is the transmitter pitch angle. It is also the Settings menu icon for changing the pitch angle units between percent and degrees. <i>Page 30</i>
	Transmitter Roll Indicator – Shows the transmitter's roll position. The roll value appears in the center of the clock. When roll offset is enabled, the letters "RO" appear at the bottom right and the solid round indicator becomes a circle. <i>Page 30</i>
	Transmitter Signal Strength – The number next to this icon on the Locate screen is the transmitter signal strength. During a calibration failure, an up or down arrow with this icon indicates signal strength is too high or too low, respectively. Maximum signal strength is about 1285. <i>Page 30</i>
	Transmitter Temperature – The number next to this icon shows the transmitter temperature. An up or down arrow indicates the trend from the last reading. The icon will display steam and flash when the transmitter becomes dangerously hot, indicating the transmitter must be cooled immediately or it will be damaged. <i>Page 58</i>
	Trigger Click Prompt – Appears on the calibration screens to indicate that a trigger click is required. Allowing this screen to time out opens the AGR screen. <i>Page 21</i>
	Warning – This error symbol indicates a failure in a self-test or a need to calibrate the receiver to one or both transmitter bands. <i>Page 31</i>

Appendix C: Projected Depth Versus Actual Depth and the Fore/Aft Offset

What Happens When the Transmitter Is Steep and Deep

The signal field emitted by the transmitter consists of a set of elliptical signals, or “flux lines”. The flux lines indicate the position of the transmitter. When the transmitter is level with respect to the ground, the locate line (LL) is directly over the transmitter, the depth displayed on the receiver is the actual depth, and the locate points (FLP and RLP) are at equal distances from the transmitter. The location of the LL is found at the intersection of the ground and the horizontal component of the flux field; the FLP and RLP are found where the vertical components of the flux field intersect with the ground. Some of the horizontal and vertical components are identified below by short yellow lines.

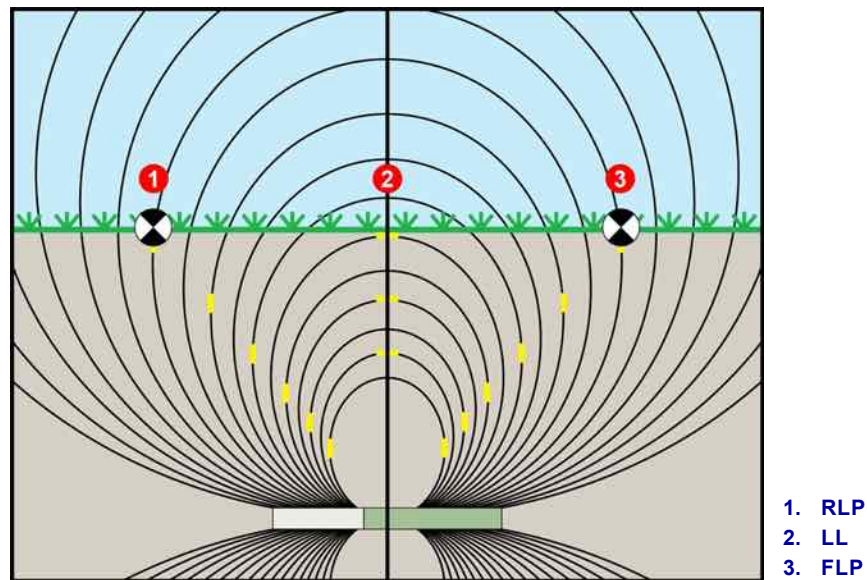

Side View of Flux Field and Geometry of FLP, RLP, and LL

Due to the shape of the transmitter’s signal field, when it is at a pitch greater than $\pm 10\%$ ($\pm 5.7^\circ$) and/or a depth of 15 ft. or more, the position of the locate line will be some distance ahead of or behind the transmitter’s actual position. In this case, the depth displayed on the receiver becomes what is called the projected depth. The transmitter’s distance ahead of or behind the locate line is called the fore/aft offset.

The projected depth and fore/aft offset must be accounted for when the transmitter is steep and/or deep. See [Table C1](#) and [Table C2](#) to determine the actual depth and fore/aft offset when you know the displayed (projected) depth and pitch of the transmitter.

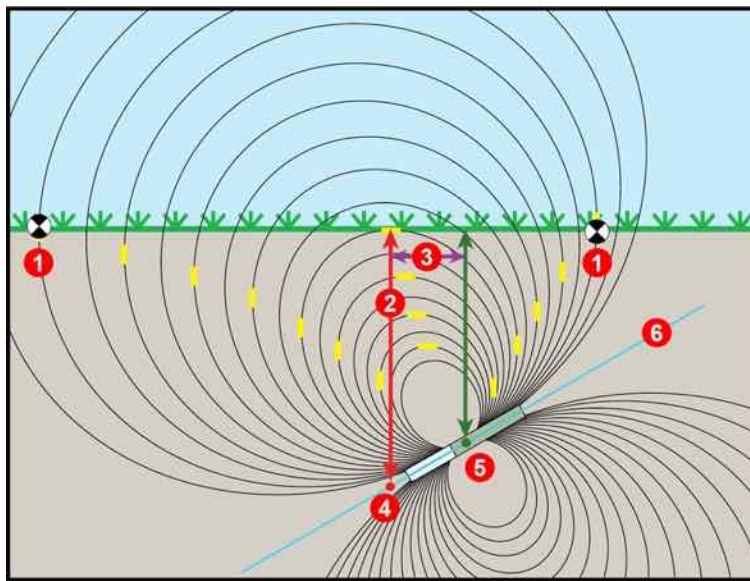

1. LP
2. LL
3. Fore/aft offset
4. Projected depth
5. Actual depth
6. 30% (17°) pitch

Side View of Actual Depth due to Fore/Aft Offset When Steep and Deep

The above figure shows a transmitter positioned in a drill string that is drilling at either a positive or a negative pitch—the pitch is positive if you are drilling left to right, negative if you are drilling right to left. The transmitter's signal field is also pitched at the same angle as the transmitter. The locate line (LL), which is where the depth measurement is taken, is the horizontal component of the transmitter's signal field flux lines. That is, the LL is found where the flux lines are horizontal, illustrated by short horizontal yellow lines above.

The locate points (FLP and RLP) are also shown above. These points are located at the vertical components of the signal field illustrated by short vertical yellow lines above. Note how the locate points are not the same distance from the LL when the transmitter is pitched. Again, this situation requires compensation for the projected depth and the fore/aft offset.

Using the following tables to find:

- **actual depth** based on the receiver's depth reading (projected depth) and the transmitter pitch – [Table C1](#)
- **fore/aft offset** based on the receiver's depth reading (projected depth) and the transmitter pitch – [Table C2](#)
- **projected depth** that you will see on the receiver during drilling if you know the required depth (actual depth) of your installation – [Table C3](#)
- **conversion factors** for determining the projected depth from the actual depth, or the actual depth from the projected depth at various transmitter pitches – [Table C4](#)

These "steep and deep" calculations for projected depth are important when using a bore plan that has specified target depths on steeper and deeper bores.

Pitch → Displayed Depth ↓	±10% (5.7°)	±20% (11°)	±30% (17°)	±40% (22°)	±50% (27°)	±60% (31°)	±75% (37°)	±90% (42°)	±100% (45°)
5'	5'	4' 11"	4' 9"	4' 6"	4' 4"	4' 2"	3' 10"	3' 6"	2' 6"
10'	9' 11"	9' 9"	9' 5"	9' 1"	8' 8"	8' 3"	7' 7"	7'	5'
15'	14' 11"	14' 8"	14' 2"	13' 7"	13'	12' 5"	11' 5"	10' 6"	7' 6"
20'	19' 11"	19' 6"	18' 10"	18' 1"	17' 4"	16' 6"	15' 3"	14'	10'
25'	24' 11"	24' 5"	23' 7"	22' 8"	21' 8"	20' 8"	19'	17' 6"	12' 6"
30'	29' 10"	29' 3"	28' 3"	27' 2"	26'	24' 9"	22' 10"	21'	15'
35'	34' 10"	34' 2"	33' 1"	31' 8"	30' 4"	28' 11"	26' 8"	24' 6"	17' 6"
40'	39' 10"	39'	37' 9"	36' 2"	34' 8"	33'	30' 5"	28'	20'
45'	44' 9"	43' 11"	42' 5"	40' 9"	39'	37' 2"	34' 3"	31' 7"	22' 6"
50'	49' 9"	48' 9"	47' 2"	45' 3"	43' 4"	41' 3"	38' 1"	35' 1"	25'

Table C1: Determining Actual Depth from Displayed (Projected) Depth and Pitch

Use the projected/displayed depth values in the first column and transmitter pitches in the first row to find actual depth.

Pitch → Displayed Depth ↓	±10% (5.7°)	±20% (11°)	±30% (17°)	±40% (22°)	±50% (27°)	±60% (31°)	±75% (37°)	±90% (42°)	±100% (45°)
5'	4"	8"	11"	1' 3"	1' 7"	1' 9"	2' 1"	2' 5"	2' 6"
10'	8"	1' 4"	1' 11"	2' 6"	3' 1"	3' 6"	4' 2"	4' 9"	5'
15'	1'	2'	2' 11"	3' 9"	4' 7"	5' 4"	6' 3"	7' 1"	7' 6"
20'	1' 4"	2' 7"	3' 10"	5'	6' 1"	7' 1"	8' 4"	9' 6"	10'
25'	1' 8"	3' 3"	4' 10"	6' 3"	7' 7"	8' 10"	10' 5"	11' 10"	12' 6"
30'	2'	3' 11"	5' 10"	7' 6"	9' 2"	10' 7"	12' 6"	14' 2"	15'
35'	2' 4"	4' 7"	6' 9"	8' 9"	10' 8"	12' 5"	14' 8"	16' 7"	17' 6"
40'	2' 8"	5' 3"	7' 9"	10'	12' 2"	14' 2"	16' 9"	18' 11"	20'
45'	3'	5' 11"	8' 8"	11' 4"	13' 8"	15' 11"	18' 10"	21' 3"	22' 6"
50'	3' 4"	6' 7"	9' 4"	12' 7"	15' 3"	17' 8"	20' 11"	23' 8"	25'

Table C2: Determining Fore/Aft Offset from Displayed (Projected) Depth and Pitch

Use the projected/displayed depth values in the first column and transmitter pitches in the first row to find fore/aft offset values.

Pitch → Actual Depth ↓	±10% (5.7°)	±20% (11°)	±30% (17°)	±40% (22°)	±50% (27°)	±60% (31°)	±75% (37°)	±90% (42°)	±100% (45°)
5'	5'	5' 2"	5' 3"	5' 6"	5' 8"	5' 11"	6' 3"	6' 6"	7' 6"
10'	10' 1"	10' 3"	10' 7"	10' 11"	11' 4"	11' 9"	12' 5"	13'	15'
15'	15' 1"	15' 5"	15' 10"	16' 5"	17'	17' 8"	18' 7"	19' 6"	22' 6"
20'	20' 1"	20' 6"	21' 2"	21' 11"	22' 8"	23' 6"	24' 9"	26'	30'
25'	25' 2"	25' 8"	26' 5"	27' 5"	28' 4"	29' 5"	31'	32' 6"	37' 6"
30'	30' 2"	30' 9"	31' 9"	32' 10"	34'	35' 3"	37' 2"	39'	45'
35'	35' 2"	35' 11"	37'	38' 4"	36' 8"	41' 2"	43' 4"	45' 6"	52' 6"
40'	40' 2"	41'	42' 3"	43' 10"	45' 4"	47'	49' 7"	52'	60'
45'	45' 3"	46' 2"	47' 7"	49' 3"	51'	52' 2"	55' 9"	58' 6"	67' 6"
50'	50' 3"	51' 3"	52' 10"	54' 9"	56' 8"	58' 9"	61' 11"	64' 11"	75'

Table C3: Determining Projected Depth from Actual Depth and Pitch

Use the actual depth values in the first column and transmitter pitches in the first row to find projected depth values.

Pitch →	±10% (5.7°)	±20% (11°)	±30% (17°)	±40% (22°)	±50% (27°)	±60% (31°)	±75% (37°)	±90% (42°)
From Actual to Projected Depth	1.005	1.025	1.06	1.105	1.155	1.212	1.314	1.426
From Projected to Actual Depth	0.995	0.975	0.943	0.905	0.866	0.825	0.761	0.701

Table C4: Conversion Factors for Calculating Exact Projected Depth or Actual Depth

Table C4 helps calculate the exact projected depth reading as well as the actual depth using a multiplier (conversion factor) at different transmitter pitches.

For example, if you have a required (actual) depth of 24 ft. and want the receiver's projected depth reading at a 30% (17°) pitch, use the first row of conversion factors to select the corresponding value for a pitch of 30%, which is 1.06. Multiply this value by the required depth of 24. The result, 25 ft. 5 in., is what the receiver's projected depth reading should be at the locate line.

Using the projected depth displayed on the receiver, you can calculate the actual depth of the transmitter using the second row of conversion factors. For example, if your pitch is 30% and your projected depth reading is 24 ft., multiply depth 24 by conversion factor 0.943. The result, 22 ft. 8 in., is the actual depth of the transmitter.

Appendix D: Calculating Depth Based on Distance Between FLP and RLP

If you know the transmitter pitch, the positions of the front locate point (FLP) and the rear locate point (RLP), and if the ground surface is level, you can still estimate the transmitter depth even if the depth information displayed on the receiver becomes unreliable.

To estimate the transmitter depth, first measure the distance between the FLP and the RLP. The pitch of the transmitter must also be reliably known. Using the Depth Estimation Table below, find the divider that most closely corresponds to the transmitter pitch. Then use the following formula to estimate the depth:

$$\text{Depth} = \text{Distance between FLP and RLP} / \text{Divider}$$

For example, if the transmitter pitch is 34% (or 18.8°) then the corresponding divider value (from the table) is 1.50. In this example, the distance between the FLP and the RLP is 11.5 ft. The depth would be:

$$\text{Depth} = 11.5 \text{ ft.} / 1.50 = 7.66 \text{ ft.}$$

Pitch (% / °)	Divider	Pitch (% / °)	Divider	Pitch (% / °)	Divider
0 / 0.0	1.41	34 / 18.8	1.50	68 / 34.2	1.74
2 / 1.1	1.41	36 / 19.8	1.51	70 / 35.0	1.76
4 / 2.3	1.42	38 / 20.8	1.52	72 / 35.8	1.78
6 / 3.4	1.42	40 / 21.8	1.54	74 / 36.5	1.80
8 / 4.6	1.42	42 / 22.8	1.55	76 / 37.2	1.82
10 / 5.7	1.42	44 / 23.7	1.56	78 / 38.0	1.84
12 / 6.8	1.43	46 / 24.7	1.57	80 / 38.7	1.85
14 / 8.0	1.43	48 / 25.6	1.59	82 / 39.4	1.87
16 / 9.1	1.43	50 / 26.6	1.60	84 / 40.0	1.89
18 / 10.2	1.44	52 / 27.5	1.62	86 / 40.7	1.91
20 / 11.3	1.45	54 / 28.4	1.63	88 / 41.3	1.93
22 / 11.9	1.45	56 / 29.2	1.64	90 / 42.0	1.96
24 / 13.5	1.46	58 / 30.1	1.66	92 / 42.6	1.98
26 / 14.6	1.47	60 / 31.0	1.68	94 / 43.2	2.00
28 / 15.6	1.48	62 / 31.8	1.69	96 / 43.8	2.02
30 / 16.7	1.48	64 / 32.6	1.71	98 / 44.4	2.04
32 / 17.7	1.49	66 / 33.4	1.73	100 / 45.0	2.06

Depth Estimation Table

Appendix E: Reference Tables

Depth Increase in Inches per 10-foot Rod

Percent	Depth Increase	Percent	Depth Increase
1	1"	28	32"
2	2"	29	33"
3	4"	30	34"
4	5"	31	36"
5	6"	32	37"
6	7"	33	38"
7	8"	34	39"
8	10"	35	40"
9	11"	36	41"
10	12"	37	42"
11	13"	38	43"
12	14"	39	44"
13	15"	40	45"
14	17"	41	46"
15	18"	42	46"
16	19"	43	47"
17	20"	44	48"
18	21"	45	49"
19	22"	46	50"
20	24"	47	51"
21	25"	50	54"
22	26"	55	58"
23	27"	60	62"
24	28"	70	69"
25	29"	80	75"
26	30"	90	80"
27	31"	100	85"

Depth Increase in Inches per 15-foot Rod

Percent	Depth Increase	Percent	Depth Increase
1	2"	28	49"
2	4"	29	50"
3	5"	30	52"
4	7"	31	53"
5	9"	32	55"
6	11"	33	56"
7	13"	34	58"
8	14"	35	59"
9	16"	36	61"
10	18"	37	62"
11	20"	38	64"
12	21"	39	65"
13	23"	40	67"
14	25"	41	68"
15	27"	42	70"
16	28"	43	71"
17	30"	44	72"
18	32"	45	74"
19	34"	46	75"
20	35"	47	77"
21	37"	50	80"
22	39"	55	87"
23	40"	60	93"
24	42"	70	103"
25	44"	80	112"
26	45"	90	120"
27	47"	100	127"

DCI Standard Warranty

DCI warrants that it will either repair or replace any product that fails to operate in conformity to DCI's published specifications at the time of shipment due to a defect in materials or workmanship during the warranty period for that product, subject to the terms set forth below.

Category	Warranty Period
Falcon Transmitters (19" and 15")	Three years from date of purchase or first 500 hours of use, whichever occurs first.
All Other Transmitters	Ninety days from date of purchase
Receivers, Remote Displays, Battery Chargers and Rechargeable Batteries	One year from date of purchase
Software*	One year from date of purchase
Other Accessories	Ninety days from date of purchase
Service/Repair	Ninety days from date of repair

* For software products, in lieu of the warranty set forth above, DCI warrants that it will either update any defective software to bring it into material compliance with DCI's specifications for such software, or refund the purchase price paid for the software.

Terms

- The 3-yr/500-hr warranty period for a Falcon transmitter is conditioned on registration of the purchase with DCI within 90 days of the date of purchase. *If the customer fails to register the purchase during this time frame, the warranty period for the transmitter will instead be ninety days from date of purchase.*
- Warranty coverage for a warranty **replacement** transmitter shall tie back to the original transmitter(s) submitted for warranty coverage. For example, if a Falcon transmitter is owned for one year and used for 250 hours, the warranty coverage for the replacement will be an additional two years or an additional 250 hours of use, whichever comes first.
- "Hours of use" for purposes of the Falcon transmitter warranty means active run-time hours, as measured internally by Falcon transmitters.
- In the event of a valid warranty submission, the choice of remedy (for example, to repair or replace a defective product or, in the case of defective software, to update or refund), shall be at DCI's sole discretion. DCI reserves the right to use remanufactured replacement parts for repairs.
- The above warranties only apply to new products purchased directly from DCI or from a DCI-authorized dealer.
- The ultimate determination of whether a product qualifies for warranty replacement shall be at DCI's sole discretion.

Exclusions

- Transmitters that have exceeded the maximum temperature, as indicated by the system.
- Defect or damage caused by misuse, abuse, improper installation, improper storage or transport, neglect, accident, fire, flood, use of incorrect fuses, contact with high voltages or injurious substances, use of system components not manufactured or supplied by DCI, failure to follow the operator's manual, use other than that for which the product was intended or other events beyond the control of DCI.
- Any transmitter used with an improper housing, or damage caused to a transmitter from improper installation into or retrieval from a housing.
- Damage during shipment to DCI.

Any modification, opening up, repair or attempted repair of a product, or any tampering or removal of any serial number, label or other identification of the product, will void the warranty.

DCI does not warrant or guarantee the accuracy or completeness of data generated by HDD guidance/locating systems. The accuracy or completeness of such data may be impacted by a variety of factors, including (without limitation) active or passive interference and other environmental conditions, failure to calibrate or use the device properly and other factors. DCI also does not warrant or guarantee, and disclaims liability for, the accuracy and completeness of any data generated by any external source that may be displayed on a DCI device, including (without limitation) data received from a drill rig.

DCI may make changes in design and improvements to products from time to time. DCI shall have no obligation to upgrade any previously manufactured DCI product to include any such changes.

THE FOREGOING IS THE SOLE WARRANTY FOR DCI PRODUCTS (OTHER THAN THE 5-YR/750-HR EXTENDED WARRANTY FOR FALCON 15/19" TRANSMITTERS). DCI DISCLAIMS ALL OTHER WARRANTIES, EXPRESS OR IMPLIED, INCLUDING BUT NOT LIMITED TO IMPLIED WARRANTIES OF MERCHANTABILITY AND FITNESS FOR A PARTICULAR PURPOSE, IMPLIED WARRANTY OF NON-INFRINGEMENT, AND ANY IMPLIED WARRANTY ARISING FROM COURSE OF PERFORMANCE, COURSE OF DEALING, OR USAGE OF TRADE, ALL OF WHICH ARE HEREBY DISCLAIMED.

In no event shall DCI or anyone else involved in the creation, production, sale or delivery of the DCI product ("partners") be liable for any damages arising out of the use or inability to use the DCI product, including but not limited to indirect, special, incidental, or consequential damages, or for any cover, loss of information, profit, revenue or use, based upon any claim for breach of warranty, breach of contract, negligence, strict liability, or any other legal theory, even if DCI has been advised of the possibility of such damages. In no event shall DCI or its partners' liability exceed the purchase price for the product.

This warranty is not assignable or transferable. This warranty is the entire agreement between DCI and purchaser, and may not be expanded or amended in any way other than in writing by DCI.

Product demonstrations

DCI personnel may be present at a job site to demonstrate basic usage, features, and benefits of DCI products. DCI personnel are present only to demonstrate a DCI product. DCI does NOT provide locating services or other consulting or contracting services. DCI does not assume any duty to train the user or any other person, and does not assume responsibility or liability for the locating or other work performed at a job site at which DCI personnel or equipment are or have been present.