

TransPort® PT878

Portable Liquid Flowmeter

User's Manual



GE

Measurement & Control

TransPort® PT878

Portable Liquid Flowmeter

User's Manual

910-219 G

February 2015



www.ge-mcs.com

©2015 General Electric Company. All rights reserved.
Technical content subject to change without notice.

[no content intended for this page - proceed to next page]

Information Paragraphs

Note: *These paragraphs provide additional information about the topic which is helpful but is not essential to proper completion of the task.*

Important: *These paragraphs provide emphasis to instructions that are essential to proper setup of the equipment. Failure to follow these instructions carefully may cause unreliable performance.*



WARNING! Indicates a potentially hazardous situation which can result in serious personal injury or death, if it is not avoided.



CAUTION! Indicates a potentially hazardous situation which can result in minor or moderate injury to personnel or damage to the equipment, if it is not avoided.

Safety Issues



WARNING! It is the responsibility of the user to make sure all local, county, state and national codes, regulations, rules and laws related to safety and safe operating conditions are met for each installation.

Auxiliary Equipment

Local Safety Standards

The user must make sure that he operates all auxiliary equipment in accordance with local codes, standards, regulations, or laws applicable to safety.

Working Area



WARNING! Auxiliary equipment may have both manual and automatic modes of operation. As equipment can move suddenly and without warning, do not enter the work cell of this equipment during automatic operation, and do not enter the work envelope of this equipment during manual operation. If you do, serious injury can result.



WARNING! Make sure that power to the auxiliary equipment is turned OFF and locked out before you perform maintenance procedures on the equipment.

Qualification of Personnel

Make sure that all personnel have manufacturer-approved training applicable to the auxiliary equipment.

Personal Safety Equipment

Make sure that operators and maintenance personnel have all safety equipment applicable to the auxiliary equipment. Examples include safety glasses, protective headgear, safety shoes, etc.

Unauthorized Operation

Make sure that unauthorized personnel cannot gain access to the operation of the equipment.

Environmental Compliance

Waste Electrical and Electronic Equipment (WEEE) Directive

GE Measurement & Control is an active participant in Europe's *Waste Electrical and Electronic Equipment (WEEE)* take-back initiative, directive 2012/19/EU.



The equipment that you bought has required the extraction and use of natural resources for its production. It may contain hazardous substances that could impact health and the environment.

In order to avoid the dissemination of those substances in our environment and to diminish the pressure on the natural resources, we encourage you to use the appropriate take-back systems. Those systems will reuse or recycle most of the materials of your end life equipment in a sound way.

The crossed-out wheeled bin symbol invites you to use those systems.

If you need more information on the collection, reuse and recycling systems, please contact your local or regional waste administration.

Visit <http://www.ge-mcs.com/en/about-us/environmental-health-and-safety/1741-weee-req.html> for take-back instructions and more information about this initiative.

[no content intended for this page - proceed to next page]

Chapter 1. Features and Capabilities

1.1 Overview	1
1.2 System Description	2
1.2.1 The Flowcell	2
1.2.2 Electronics Package	3
1.3 Theory of Operation	4

Chapter 2. Initial Setup

2.1 Making Electrical Connections	6
2.1.1 Power Connections	7
2.1.2 Transducer Connections	7
2.1.3 Input/Output Connections	7
2.1.4 The USB Port	8
2.2 Caring for the PT878 Batteries	12
2.2.1 Charging and Storing the Batteries	12
2.2.2 Replacing the Batteries	13
2.2.3 Disposing of Batteries	14
2.3 Powering ON and OFF	15
2.4 Using the Screen and Keypad	18
2.4.1 Screen	18
2.4.2 Keypad	20
2.5 Obtaining On-Line Help	22

Chapter 3. Programming Site Data

3.1	Entering the Program Menu	22
3.2	Entering Transducer Parameters	23
3.2.1	Parameters for Special Transducers	26
3.2.2	Confirming Entries	30
3.3	Entering Pipe Parameters	30
3.4	Entering Pipe Lining Parameters.....	35
3.5	Entering Fluid Types and Speeds	37
3.6	Entering the Signal Path Parameters.....	39
3.6.1	Path Parameters for Clamp-On Transducers	40
3.6.2	Path Parameters for Wetted Transducers	41
3.7	Entering the Energy Option Parameters.....	42
3.7.1	Entering Inputs in the Energy Option	44
3.7.2	Entering Custom Cp Data in the Energy Option	46
3.8	Entering Analog Inputs.....	50
3.8.1	Entering General-Purpose Analog Inputs	50
3.8.2	Entering Analog Inputs in the Energy Option.....	52
3.9	Entering the Analog Output	54
3.10	Entering the Digital Output.....	57
3.11	Entering User Functions.....	61
3.11.1	Entering Correction Factors.....	65
3.11.2	Entering Reynolds Correction	65
3.11.3	Entering a Calibration Factor	67

Chapter 4. Creating and Managing Sites

4.1 The Site Manager	72
4.1.1 Creating a New Site	74
4.1.2 Opening an Existing Site	76
4.1.3 Saving a Site	77
4.1.4 Saving a Site with a Different Name	78
4.1.5 Refreshing a Site	79
4.1.6 Renaming a Site	79
4.1.7 Deleting a Site	80
4.1.8 Creating a Site Message	81
4.1.9 Transfer Files Between the PT878 and a PC	83
4.1.10 Listing Files by Name	86
4.1.11 Listing Files in Chronological Order	87

Chapter 5. Displaying and Configuring Data

5.1 The Format Option	90
5.2 The View Option	92
5.3 The Limits Option	93
5.4 The Measurement Option	95
5.5 Customizing the Display Screen	97
5.5.1 Specifying the Number of Displayed Parameters	98
5.5.2 Customizing Softkeys	99
5.6 Managing Files — The Drive Manager	102
5.6.1 Transferring a File to a PC	104
5.6.2 Transferring a File from a PC to the PT878	105
5.6.3 Refreshing a File	106
5.6.4 Deleting a File	107
5.6.5 Listing Files by Name	108
5.6.6 Listing Files in Chronological Order	108
5.7 Accessing Meter Data —The About Option	109

Chapter 6. Programming Meter Settings

6.1	Entering the Meter Menu	112
6.2	Selecting Measurement Units	113
6.3	The Battery Charger	114
6.4	Entering Date and Time	115
6.5	Changing Date and Time Appearance	117
6.6	Adjusting the Contrast	120
6.7	Setting Backlight Timeout	121
6.8	Changing the Display Language	122
6.9	Changing Communications Settings	123
6.10	Resetting Forward and Reverse Totals	126
6.11	Setting Up User Tables	127
6.12	Taking a Bitmap Capture of a Current Screen	130

Chapter 7. Logging Data

7.1	Entering the Logging Menu.....	132
7.2	The Log Manager.....	133
7.3	The File Menu.....	134
7.3.1	Setting up a New Log.....	135
7.3.2	Copying (Cloning) a Selected Log.....	140
7.3.3	Renaming a Log.....	141
7.3.4	Deleting a Log.....	141
7.3.5	Deleting All Logs.....	142
7.3.6	Refreshing the Log Manager Screen.....	142
7.3.7	Transferring a Log to a PC.....	143
7.4	The Log Menu.....	146
7.4.1	Stopping (Pausing) a Log.....	147
7.4.2	Restarting a Log.....	147
7.4.3	Ending a Log.....	147
7.4.4	Stopping All Logs.....	148
7.4.5	Restarting All Logs.....	148
7.4.6	Ending All Logs.....	148
7.4.7	View All Sites.....	148
7.5	The View Menu.....	149
7.5.1	Displaying Log Details.....	150
7.5.2	Displaying Log Data in Graphical Form.....	151
7.5.3	Displaying Log Data in Spreadsheet Form.....	154
7.6	The Sort Menu.....	155
7.6.1	Listing Logs by Name.....	155
7.6.2	Listing Logs in Chronological Order.....	155

Chapter 8. Servicing the PT878

8.1	Entering the Service Menu	158
8.2	Transferring Reports	159
8.3	Setting up the Thickness Gauge	162
8.4	Measuring Pipe Wall Thickness	163
8.4.1	Entering the Material and Soundspeed	163
8.4.2	Measuring Thickness in Numeric Format	165
8.4.3	Displaying the Receive Signal in Graphical Format	166
8.4.4	Calibrating the Thickness Gauge Transducer	168
8.4.5	Calculating Velocity (Pipe Material Soundspeed)	171
8.5	Programming the Thickness Gauge	173
8.6	Displaying Diagnostic Parameters	176
8.7	Calibrating the Analog Output and Inputs	177
8.7.1	Calibrating the Analog Output	177
8.7.2	Calibrating Inputs	179
8.8	Setting up Signal Parameters	181
8.8.1	Setting up Signal Parameters	182
8.8.2	Setting up Peak Detection	184
8.8.3	Selecting the Transmit Code	186
8.9	Setting Error Limits	187
8.10	The Test Option	190
8.10.1	Testing the Screen	191
8.10.2	Testing the Keys	192
8.10.3	Testing the Watchdog Timer Circuit	193
8.10.4	Setting Impulse Response	194
8.10.5	Taking Wave Samples for Diagnosis	195
8.10.6	Transferring a Wave Snapshot	196
8.10.7	Testing the Battery	198
8.11	Resetting to Factory Default Parameters	199
8.12	Updating PT878 Firmware	200

Chapter 9. Diagnostics and Troubleshooting

9.1 Error Code Messages	202
9.2 Displaying Diagnostic Parameters	204
9.3 Flowcell Problems	206
9.3.1 Fluid Problems	206
9.3.2 Pipe Problems	207
9.4 Transducer Problems	208
9.4.1 Wetted Transducer Problems	208
9.4.2 Clamp-on Transducer Problems	209
9.4.3 Relocating Transducers	210

Chapter 10. Specifications

10.1 Overall	213
10.1.1 Hardware Configuration	213
10.1.2 Size/Weight	213
10.1.3 Enclosure	213
10.1.4 Flow Accuracy (Velocity, % of reading):	213
10.2 Electrical	214
10.3 Operational Specifications	216
10.4 Transducer	217
10.4.1 Clamp-On Ultrasonic Flow Transducers	217
10.4.2 Temperature Transducers	217
10.5 Pipe Size and Material	217
10.5.1 Clamp-On Transducers:	217
10.6 Available Options	218

Appendix A. Menu Maps

Appendix B. Measuring P and L Dimensions

Appendix C. Temperature Transmitter Installation

C.1 Guidelines for RTD Installation	243
C.2 Mounting RTDs on the Pipe	244
C.2.1 Assembling the Clamping Fixture	244
C.2.2 Mounting the RTD to the Pipe	245
C.3 Making Electrical Connections	245
C.3.1 Connecting the RTD to the 4 to 20-mA Transmitter	246
C.3.2 Connecting the Transmitter to the PT878	247

Appendix D. Ultrasonic Thickness Gauge Theory of Operation

D.1 Factors Affecting Performance and Accuracy	250
D.1.1 Transducer Positioning/Alignment	251
D.1.2 Calibration	252
D.1.3 Taper or Eccentricity	252
D.1.4 Acoustic Properties of the Material	252

Appendix E. Material Safety Data Sheet for Couplant

E.1 Product Identification	253
E.2 Hazardous Ingredients	253
E.3 Physical Data (nominal)	254
E.4 Fire and Explosion Hazard Data	254
E.5 Reactivity Data	254
E.6 Health Hazard and First Aid Data	255
E.7 Storage and Handling Information	255
E.8 Control Measures	256

Appendix F. Glossary

Chapter 1. Features and Capabilities

The TransPort® Model PT878 is a transit-time flowmeter which combines all the features of a full-size flowmeter with the advantages of a portable instrument.

This section describes the TransPort features and general system, and explains the theory of operation.

1.1 Overview

The PT878 measures the flow rate of acoustically conductive single-phase fluids. This includes most clean liquids, sewage, some slurries, some oil/water mixtures, and liquids with a small percentage of entrained gas bubbles. The flowmeter provides one linear (0/4-20 mA) analog output of flow velocities or volumetric flow rate of these fluids, measuring velocities from ± 0.03 to ± 12 m/sec (± 0.1 to ± 40 ft/sec), along with one selectable frequency output or pulsed totalizer output.

The PT878 also provides two 4 to 20-mA analog inputs in order to connect temperature transmitters to measure energy flow rate of liquids. Energy flow rate may be calculated for water, glycol, and water/glycol mixtures.

The PT878 has the ability to store site data in files which can be accessed at a later time. Within the Main Menu, a set of forms (windows) asks you all the necessary setup information for a particular site. Once the necessary questions are answered, you simply save the information to a file.

The PT878 stores these files and other data in non-volatile memory, which retains the information even if power is off. The flowmeter itself runs on rechargeable or alkaline batteries for up to 10 hours.

This small lightweight flowmeter displays measurements in both numeric and graphical form on a EL-backlit, 240 x 200 pixel LCD graphic screen. The PT878 also has the capability of logging over 100,000 flow data points internally.

Using the USB communications port, the PT878 can transmit logged data, as well as real time data and other stored data. It is also computer-programmable via GE's PanaView™ software.

1.1 Overview (cont.)

To assist you, the PT878 is fully equipped with context-sensitive on-line help which is accessible at any time by simply pressing the “?” (Help) key. Internal diagnostic and troubleshooting features help isolate and remedy common flowcell and transducer problems.

The PT878 operates with all standard GE transducers - wetted, clamp-on, hybrids (Pan-Adapta[®] plug), and buffered styles.

A built-in ultrasonic thickness gauge capability measures the pipe wall thickness when used with the optional thickness transducer.

1.2 System Description

The PT878 is one part of the flowmeter system. The flowmeter system consists of two essential subsystems: the flowcell and the electronics package (the PT878).

1.2.1 The Flowcell

The flowcell is that part of the system that uses ultrasonic pulses to interrogate the flow. It consists of the flowcell pipe and the transducers.

- A. FLOWCELL PIPE - The flowcell can either be created in the existing piping (for example, by inserting wetted transducers into the pipe, or clamping non-wetted transducers onto the pipe), or inserted as a substitute pipe section (spoolpiece). The flowcell must provide mechanical support for the transducers and assure stable fluid conditions for accurate flow measurement.
- B. TRANSDUCERS - The transducers convert electrical energy into ultrasonic pulses when in a transmit cycle, and convert the ultrasonic pulses back to electrical energy when in a receive cycle. In other words, they act like loudspeakers when transmitting the signal and microphones when receiving it. In the PT878 system, each transducer acts as both a receiver and transmitter, since a series of ultrasonic pulses are alternately sent upstream and then downstream through the flowcell.

1.2.2 Electronics Package

The PT878 consists of circuits that generate, receive, and measure the travel time of the ultrasonic pulses. It also contains a microcomputer that controls operation and calculates flow measurement parameters. Specific circuits function as follows:

- **TRANSMIT SIGNAL GENERATOR** - The transmit signal generator, under control of the microcomputer and timing circuit, synthesizes the signal that drives the transmitter.
- **TRANSMITTER** - The transmitter amplifies the signals from the transmit signal generator to a signal that drives the transmit transducer.
- **RECEIVER** - The receiver amplifies the received signals to a level suitable for the data acquisition circuitry.
- **DATA ACQUISITION** - The data acquisition circuitry digitizes the received signal and stores it in a buffer for processing by the microcomputer.
- **TIMING CIRCUIT** - The timing circuit generates the transmitter frequency, receive window, controls the data acquisition circuit and the direction of the transmission.
- **MICROCOMPUTER** - The microcomputer controls the PT878 flowmeter's operation and calculates flow measurements derived from the transmitted and digitized received signals. Also, the microcomputer continually checks for faults and allows the use of built-in diagnostics for troubleshooting.
- **INPUT/OUTPUT** - The input/output circuitry allows the flowmeter to indicate the measured flow with the 0/4-20 mA current loop, and to output to a remote device. The digital output supports frequency or pulse output, as well as use as a gate input; it can also act as a test point for triggering an oscilloscope from the transmit or receive window.

1.3 Theory of Operation

The PT878 is a transit-time ultrasonic flowmeter. When ultrasonic pulses are transmitted through a moving liquid, the pulses that travel in the same direction as the fluid flow (downstream) travel slightly faster than the pulses that travel against the flow (upstream). The PT878 uses various digital signal processing techniques, including cross-correlation, to determine transit times and then uses the transit times to calculate flow velocity.

During operation, two transducers serve as both ultrasonic signal generators and receivers. When mounted on a pipe, they are in acoustic communication with each other, so that each transducer can receive ultrasonic signals transmitted by the other transducer. Each transducer thus functions as a transmitter generating a certain number of acoustic pulses, and as a receiver for an identical number of pulses.

The flowmeter measures the time interval between transmission and reception of the ultrasonic signals in both directions. When the liquid in the pipe is not flowing, the transit-time downstream equals the transit-time upstream. When the liquid is flowing, the transit-time downstream is less than the transit-time upstream. The difference between the downstream and upstream transit-times is proportional to the velocity of the flowing liquid, and its sign indicates the direction of flow.

Chapter 2. Initial Setup

Before making measurements, you must prepare the PT878 for operation. This includes the following procedures:

- Making Electrical Connections
- Charging and/or Replacing Batteries
- Powering On and Off
- Using the Screen and Keypad
- Obtaining On-Line Help

Figure 1 below shows the PT878 in its standard soft case (a) and in the optional solid case (b). In the solid case, the interior is structured for optimal protection of the PT878 and its accessories.



Figure 1: The PT878 and Accessories

2.1 Making Electrical Connections

Before making measurements with the PT878, you must make all the necessary connections to the unit. This section describes how to connect the following:

- Power
- Transducers
- Input/Output
- USB Interface

Make all connections to the top of the PT878 unit as shown in Figure 2 below. Please note that you need to make the proper power and transducer connections only. The other connections are required for particular functions, but are not necessary for basic operation.

Note: For a listing of Input/Output connections, see Table 1 on page 8.

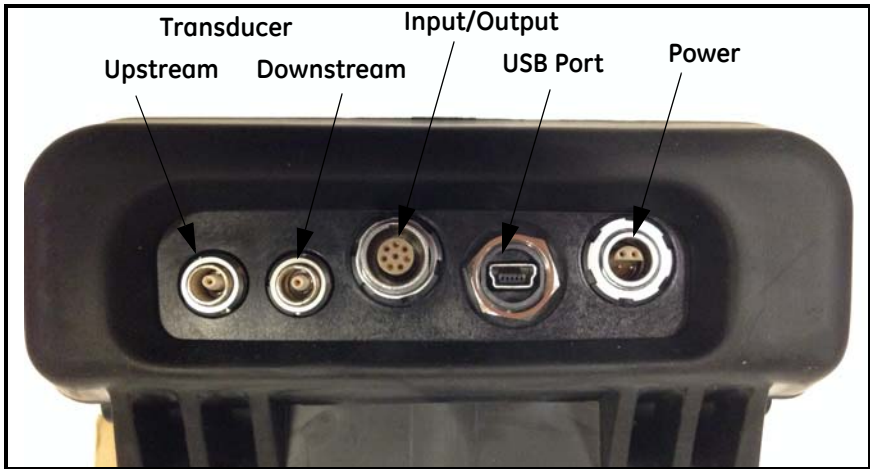

Figure 2: Connection Locations

2.1.1 Power Connections

The PT878 is powered by either a 100-120/200-260 VAC wall mount plug-in module, or by 5 internal C₅-size NiCad high-energy rechargeable batteries or by a pack of 3.0 Ahr NiMH batteries. (An optional power supplement, part #703-1283, uses 6 AA alkaline batteries.) When you receive the PT878, the batteries are not charged; therefore, to make remote measurements using the batteries, follow the instructions on page 12 to charge the batteries. In either case, you must connect the power cord to the appropriate terminal as shown in Figure 2 on page 6.



WARNING! To ensure the safe operation of the PT878, you must install and operate it as described in this manual. In addition, be sure to follow all applicable safety codes and regulations for installing electrical equipment in your area. The PT878 and its transducers are designed for use only in general-purpose locations.

2.1.2 Transducer Connections

The transducer cables connect to the PT878 with LEMO[®] coaxial type connectors. Each color-coded cable should have a collar labeled UPSTREAM or DOWNSTREAM. Make transducer cable connections to the top of the flowmeter as shown in Figure 2 on page 6. Because there are various types of transducers and installations, transducer installation is discussed separately in the *Liquid Transducer Installation Guide* (916-055).

2.1.3 Input/Output Connections

The PT878 provides one 0/4-20 mA current output and two 4 to 20-mA analog inputs with switchable 16-V supply for loop- powered temperature transmitters. It also supports digital, frequency, and totalizer outputs.

Connect the inputs/outputs using a LEMO[®] multi-pin connector as in Figure 2 on page 6. The pin numbers for the connector and the color code for the standard input/output cable are shown in Table 1 on page 8.

2.1.3 Input/Output Connections (cont.)

Table 1: Cable Assembly for Analog Inputs/Outputs

Pin Number	Wire Color	Description
1	Black	Analog Out 1
2	Red	16 V (switched)
3	White	Supply or Return Temperature (Input A)
4	Yellow	Supply or Return Temperature (Input B)
5	Green	Analog Ground
6	Orange	Digital Output (frequency output, pulse totalizer, diagnostic output or calibration gate)
7	Blue	Digital Ground
8	Violet	Receive Monitor

2.1.4 The USB Port

The TransPort™ PT878 portable ultrasonic flowmeter allows the user to update firmware, communicate with a PC running the GE PanaView™ graphical user interface software and transfer files via a built-in *USB Interface*. This manual provides instructions for performing these actions.

The PT878 USB design uses an RS232 to USB converter, which converts the USB data to standard serial port data. The RS232 communications protocol is used, which allows the meter to operate with both the GE PanaView graphical user interface software as well as commercially available terminal emulation programs such as HyperTerminal. The PT878 communications parameters, such as baud rate (300 to 38400 baud), can be set via the PT878 keypad.

Important: *All PC and PT878 communications parameters must match for successful data transfer.*

2.1.4 The USB Port (cont.)

The PT878 always ships with the latest firmware version installed. However, as new firmware versions become available, your PT878 firmware is easily updated via its USB interface.

The USB connector installed in the PT878 is IP67 rated and is leak-resistant, even if the instrument is exposed to water for a short period of time.



CAUTION! Be sure to use caution when connecting a USB cable to the PT878, if the meter's USB connector has been exposed to water.

2.1.4a USB Setup

The initial step for communicating with the PT878 through its USB interface is to make sure that the PC operating system recognizes the USB device in the PT878. This is done by connecting the PT878 to the PC with a USB cable and verifying that the PC operating system loads the correct drivers for the PT878 USB interface device.

USB Cable

The recommended USB cable for use between the PT878 and a PC is a USB A male to mini USB B male cable, such as GE p/n 238-407-LF or equivalent.

USB Drivers

To set up the USB drivers in Microsoft Windows®, complete the following steps:

1. Power on PT878.
2. Plug the mini B USB male connector into the PT878 USB port.
3. Plug the USB A male connector into any USB port on the PC.
4. Verify that Windows automatically loads the driver for the FTDI chip in the PT878.
5. Open the Control Panel>>Device Manager window and then select Ports (see Figure 3 below). Verify that the PT878 USB port is installed.

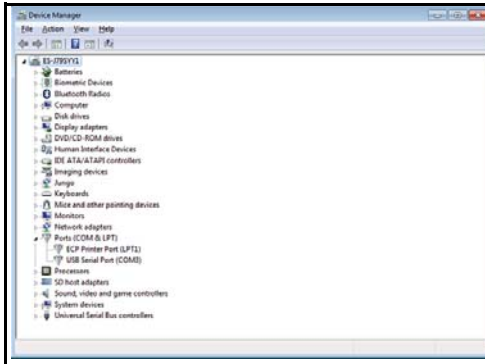

Figure 3: Device Manager Window

Note: *If the USB port is not automatically installed, the driver may be installed manually from the FTDI website.*

Install the drivers for the FT230XS UART from <http://www.ftdichip.com>.

Note: *For operation with the GE PanaView software, set the Com Port between COM1 and COM 9.*

Open the USB serial port settings window (see Figure 2 below) and match those listed in the PT878\Meter\Communications window at the PT878 UI. Note that the COM port settings may vary with the PC configuration.

USB Drivers (cont.)

The USB driver setup is now complete.

Note: *The USB driver should recognize the flowmeter each time the PT878 is reconnected to the PC, but the COM port number may change depending on the PC configuration.*

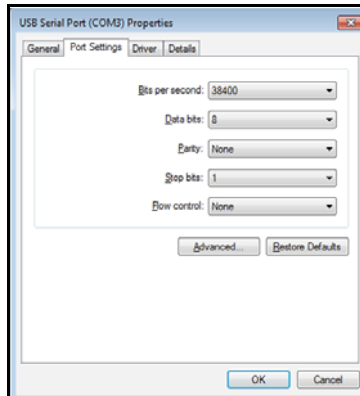

Figure 4: USB Serial Port Properties

2.2 Caring for the PT878 Batteries

The PT878 comes with self-contained, built-in rechargeable batteries to support portable operation. For optimum performance, these batteries require a minimum of maintenance.



CAUTION! Use only GE-approved batteries and desktop chargers. These chargers are designed to maximize battery life. Using other batteries or chargers voids the warranty and may cause damage.

Important: *For CE compliance, the PT878 is classified as a battery-powered device, not to be used with the AC adaptor.*

2.2.1 Charging and Storing the Batteries

When you receive the PT878, you will need to initially charge the batteries. Also, the battery may need recharging if it has not been used for a long period of time. The batteries must be charged up to 8 hours to receive the maximum charge. When fully charged, the batteries provide 8 to 10 hours of continuous operation. An internal battery gauge indicates the remaining power in the batteries.

To charge the batteries, simply plug the AC power module cord into the power jack (shown in Figure 2 on page 6) and be sure the battery pack is installed. When the PT878 is plugged into line voltage, the internal battery charger automatically charges the batteries, whether the PT878 is on or off. If the PT878 is on, the Battery icon in the upper right corner of the screen indicates battery status (as shown in Table 2 on page 13).









Note: *For version 1B of the PT878 software, you must also press the red power key in the upper right corner of the keypad. (See page 109 to determine your software version.)*

For optimal run time, charge the batteries only in temperatures from 50°F to 104°F (10°C to 40°C). Otherwise, the batteries will not be properly charged and will have a significantly reduced run time.

2.2.1 Charging and Storing the Batteries (cont.)

Store the batteries at temperatures from -4°F to 131°F (-20°C to 55°C) for periods of less than one month, or from 32°F to 104°F (0°C to 40°C) for longer periods. (If you are transporting them for two days or less, the batteries can withstand temperatures from -40°F to 158°F (-40°C to 70°C).

Table 2: Battery Status Icons

Icon	Battery Status
	Full battery
	Partially full battery
	Empty battery
	Fully charged battery, connected to AC power
	Charging battery
	Discharging battery
	Failure/missing battery
	Notification to check battery form (see page 114)

2.2.2 Replacing the Batteries



CAUTION! Replace batteries only with the specified rechargeable batteries. The battery charges when the unit is off. Do not attempt to recharge non-rechargeable batteries.

If you need to replace the rechargeable batteries, use the recommended 3.0 Ahr NiMH batteries (part number 200-081). While the batteries can be recharged up to 600 times, it is best to replace them when they no longer provide acceptable performance. To replace the batteries, remove the rubber boot, open the panel located on the back of the PT878 unit, disconnect the batteries, and replace with new ones (see Figure 5 on page 14).

2.2.2 Replacing the Batteries (cont.)

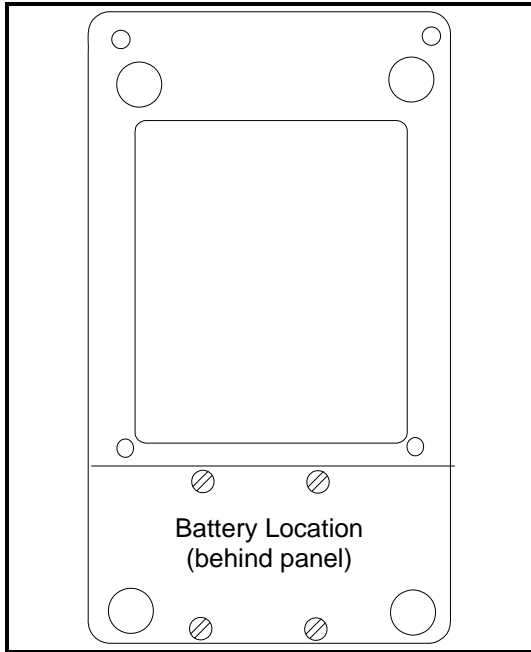

Figure 5: Battery Location

To further extend the battery power on the PT878, the GE Part #705-1283 option uses 6 AA alkaline batteries.

2.2.3 Disposing of Batteries



CAUTION! Never dispose of the batteries by incineration. Do not attempt to disassemble or short-circuit the batteries. For safety, do not handle a damaged or leaking battery.

Important: *Be sure to dispose of your battery properly. In some areas, battery disposal in business or household trash may be prohibited. For safe disposal options, contact your nearest GE-authorized service center.*

2.3 Powering ON and OFF

To operate the PT878, the power cord must be plugged into line voltage or the battery must be charged as described previously.

Important: *For CE compliance, the PT878 is classified as a battery-powered device, not to be used with the AC adapter. To comply with CE certification, do not operate the meter with the charger plugged in.*

To turn the PT878 on, press the red button in the upper-right-hand corner of the keypad. Immediately upon power up the PT878 emits a short beep and displays a “PCI Loader” message. It then validates the instrument programming, and then displays the GE logo and the software version and emits a long beep. If the meter fails any of these tests, contact the factory.



WARNING! If the meter fails the backup battery test, you must send the unit back to the factory for a battery replacement. Make sure you keep the batteries charged until you are ready to ship the unit back to the factory. Before shipping, transfer all the log and site data to your PC.

2.3 Powering ON and OFF (cont.)

After the meter conducts all the self checks, the screen then appears similar to the one shown in Figure 6 below.

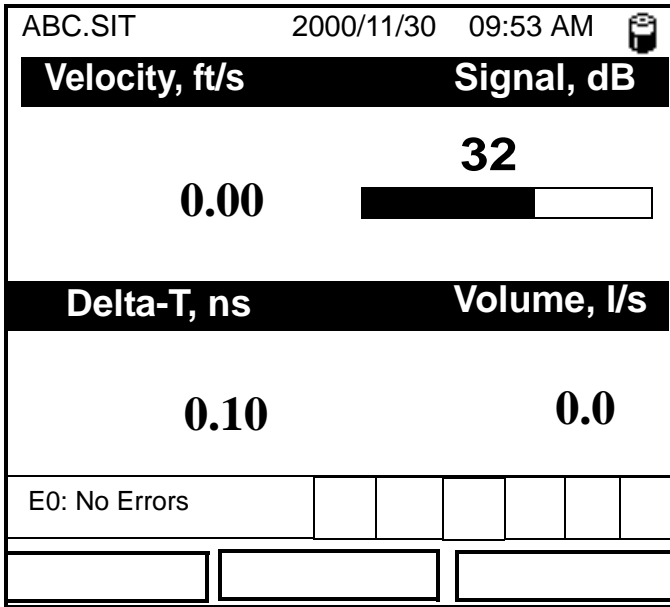

Figure 6: Screen After Powering ON

2.3 Powering ON and OFF (cont.)

To turn the PT878 off, press the red key for 3 seconds. The screen now appears similar to Figure 7 below.

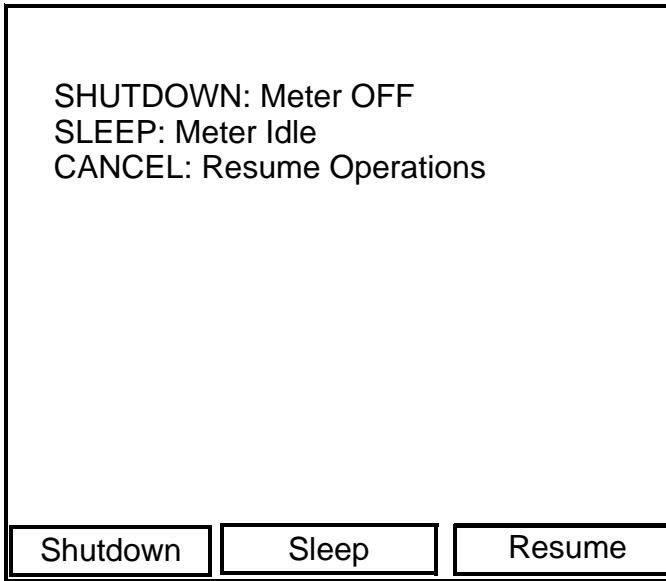

Figure 7: Shutdown Menu

Three options are available:

- Press [F1] to shut down the PT878, turning it completely off.
- Press [F2] to send the PT878 into sleep mode. In this mode, some of the power supplies shut down, but the PT878 remains in a standby mode. Users can resume taking measurements immediately by pressing the power button.
- Press [F3] to cancel the command and return the PT878 to normal operation.

If the PT878 locks up, you can reset it by holding the power key (the red key in the upper right corner) for 15 seconds.

2.4 Using the Screen and Keypad

The essential features for operating the PT878 are the screen and keypad. Although these features are common on portable instruments, the PT878 design offers particular features to simplify and speed operation.

2.4.1 Screen

The primary function of the screen is to display information in order for you to accurately and easily take measurements. The PT878 screen consists of seven parts (see Figure 8 below).

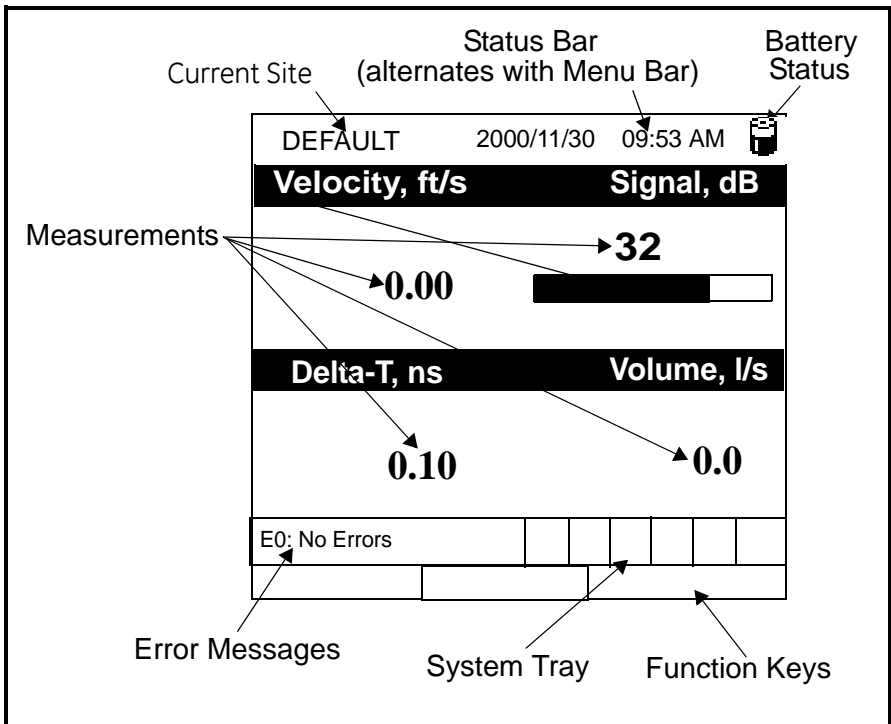

Figure 8: PT878 Screen in Operate Mode





The top line of the screen is the **status bar**, which normally displays the time and date. However, when you press [MENU] (the menu key), the **Menu Bar** replaces the status line.

2.4.1 Screen (cont).

The middle of the screen shown in Figure 8 on page 18 is the **work area**, which displays the measured parameters, numeric measurements, and both bar and line graphs. (When you enter a selection on the Menu Bar discussed in Chapter 3, *Programming Site Data*, this area displays menu prompts.) A line at the bottom of the area also displays error code messages, which are described in more detail in Chapter 9, *Diagnostics and Troubleshooting*.

The **system tray** displays icons that indicate meter operations not otherwise shown. Table 3 below lists the icons and their meanings.

Table 3: Icons in the System Tray

Icon	Function	Meaning
	Alert	Indicates the meter encountered an error in operation.
	Log	Indicates a log is pending (no marks) or running (marks).
	Heating/ cooling	Indicates heating or cooling energy mode.
	Stopwatch	Calibration Gate Operation: Watch is stopped when the gate is closed, or runs when it is open.
	Snapshot (To file)	Indicates that the Snapshot function has been activated, so users can take screen captures (see page 130).

The bottom of the screen displays the three **function key** options: F1, F2 and F3. These keys have different functions, depending on the task you are performing.

2.4.2 Keypad

The PT878 keypad has 25 keys. The functions for each key are as follows (see Figure 9 on page 21):

- 3 function keys ([F1], [F2], [F3]) — enable you to select the special functions which appear at the bottom of the screen.
- 12 numeric keys (including – and .) — enable you to enter numeric data.
- 4 arrow keys ([◀], [▶], [▲], [▼]) — enable you to move through the menu options.
- [?] Help key— enables you to access on-line help (discussed on page 22).
- [MENU] Menu key — enables you to access the Main Menu.
- [ENTER] — enables you to enter a particular menu, and enters selected values into the PT878 memory.
- [SEL] — enables you to move between data measurements on the screen.
- [ESC] — enables you to exit menus or menu options at any time; cancels a numeric entry.
- Red key [Ⓜ] — turns the power on or off, and toggles the backlight on or off.

2.4.2 Keypad (cont.)

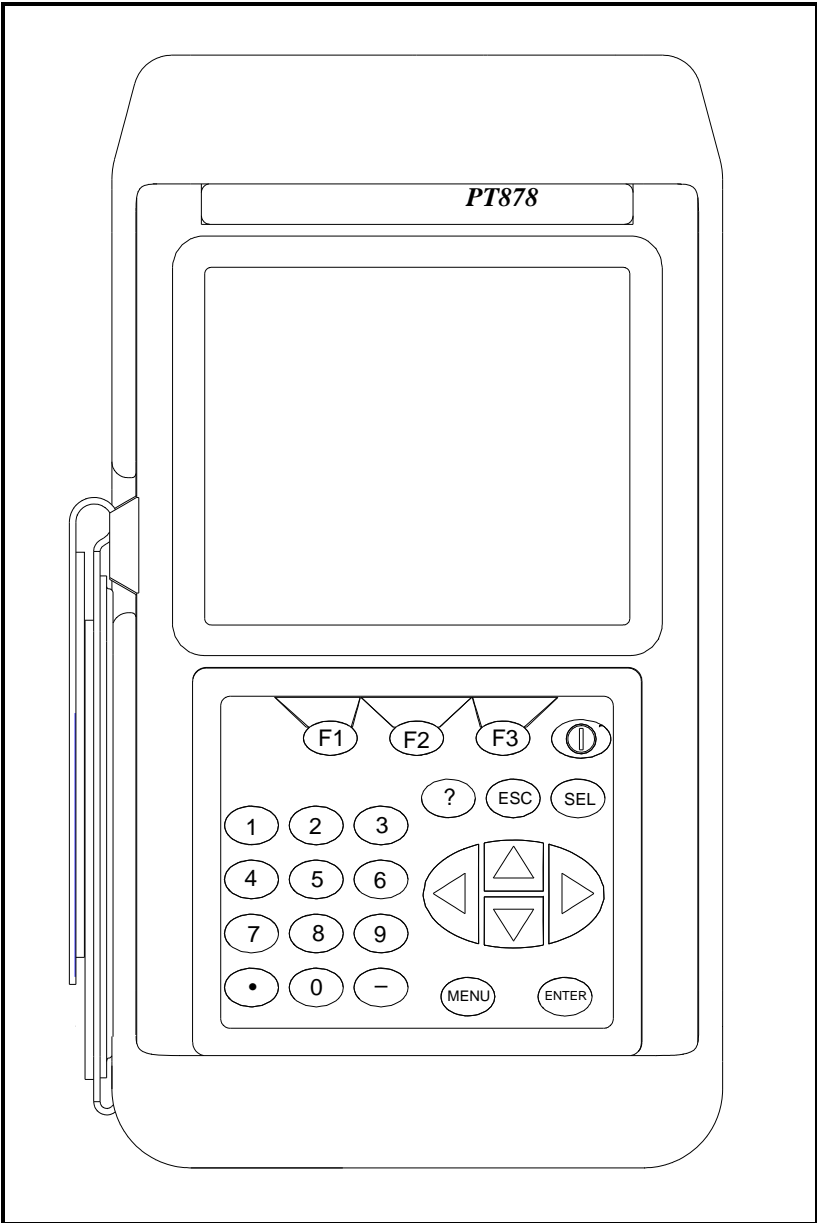

Figure 9: PT878 Keypad

2.5 Obtaining On-Line Help

The PT878 offers context-sensitive on-line help screens that describe various features. You can access on-line help at any time by pressing the [?] key. The screen appears similar to Figure 10 below.

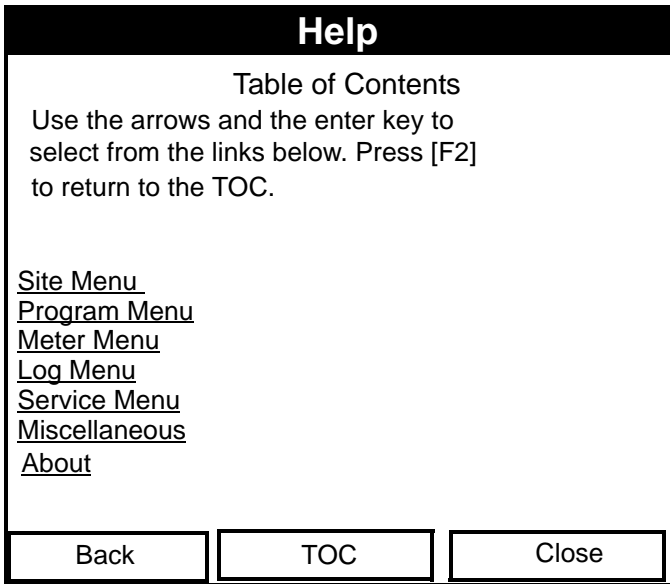

Figure 10: Main Help Menu

Use the three function keys and the [▲] and [▼] arrow keys to navigate to the desired menu, and press [ENTER]. Repeat this procedure to access the desired topic within the menu. When you have finished using the Help menu:

- Press [F1], Back, to move back one level.
- Press [F2], TOC, to return to the Table of Contents.
- Press [F3], Close, to return to the previous screen.

Chapter 3. Programming Site Data

On the PT878, a Program Menu (part of the Main Menu) enables you to enter information that is specific to each site:

- Transducer types and paths
- Pipe materials and linings
- Fluid types
- Heating or cooling energy flow rate
- Analog input and output parameters
- Digital output parameters
- User functions
- Correction factors

For immediate operation, the PT878 requires only transducer, pipe and fluid data. However, additional information allows you to tailor measurements as specifically as possible to your particular application. Once you have entered this data, you can save it in files and recall these files for later use. The PT878 can store up to 1 MB (or 32 site files) of data in the meter at any one time. But through the USB link, users can store an unlimited number of sites in a PC, and then upload the sites they will actually use.

This chapter covers entering:

- Transducer, pipe, and fluid parameters
- Input/output and other setup parameters
- User functions.

3.1 Entering the Program Menu

To enter the Program Menu, press the [MENU] key at the lower right of the PT878 keypad. The Menu Bar replaces the Status Bar at the top of the screen. Press the [▶] arrow key once to scroll from the Site Menu to the Program Menu. At the Program Menu, press [ENTER]. The screen appears similar to Figure 9 below. While following the programming instructions, see Figure 139 on page 222 of Appendix A, *Menu Maps*.

Site	Program	Meter Logging	Service
Vel	Transducer	Signal, dB	
	Pipe Lining Fluid Path	32	
	Energy	<input type="text"/>	
D	Analog Input	Volume, l/s	
	Analog Output	0.0	
	Digital Output		
	User Functions		
	Correction Factors		
E0: No Errors		<input type="text"/>	<input type="text"/>
		<input type="text"/>	<input type="text"/>

Figure 9: Program Menu

To scroll to a particular option, press the [▼] or [▲] arrow keys until you reach the option. Then press [ENTER] to open the option window.

When entering parameters in an option, press:

- The [▼] key to step through the available parameters
- The [▲] key to scroll back to a previously entered parameter
- The [F2] key (Cancel) or the [ESC] key to exit an option at any time and return to Operate Mode without changing the parameters.

Note: *If you enter an incorrect numeric value, press the [◀] key to erase the last digit entered.*

3.2 Entering Transducer Parameters

To enter the Transducer option, scroll to the Transducer entry on the Program Menu and press [ENTER]. The screen appears similar to Figure 10 below. To step through each parameter, press the [▼] key. Refer to Figure 143 on page 227 of Appendix A.

Note: Refer to the Liquid Transducer Installation Guide (916-055) for additional information about transducers and configurations.

Figure 10: Transducer Option Window

1. The first prompt asks you to select whether you are using a wetted or a clamp-on transducer.
 - a. Use the [◀] and [▶] keys to scroll between the two types.
 - b. Press [ENTER] to confirm the choice.

3.2 Entering Transducer Parameters (cont.)

Note: *The choices made early in the Transducer and Pipe options determine the prompts available later. If the PT878 does not scroll to a particular parameter, it is not necessary for that transducer or pipe type. For example, the Lining window is not available if you select a wetted transducer.*

2. The next prompt asks you to enter the transducer number (printed on the transducer itself), or to specify that you are using a special application transducer.
 - a. From the Type prompt, press the [▼] key to reach the Transducer prompt, and press [ENTER].
 - b. A drop-down list of transducer numbers opens as in Figure 11 on page 25. (The list varies, depending on whether you have selected wetted or clamp-on in the previous prompt. See Table 4 on page 25.) Press the [▼] or [▲] keys to scroll to the appropriate number, or scroll to “Special” for a special application transducer. To speed scrolling, you can press the [▶] key to scroll down by a page, or the [◀] key to scroll up by a page.
 - c. Press [ENTER] to confirm your selection.

The program now varies, depending on whether you have selected standard or special transducers.

- If you have selected a standard wetted or clamp-on transducer, the PT878 comes programmed with the needed parameters. Proceed to *Confirming Entries* on page 30.
- However, if you have selected a special application transducer, go to page 26.

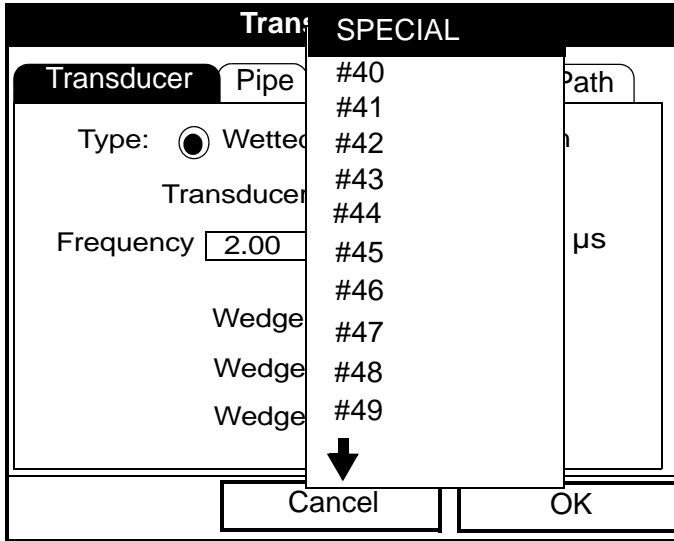

Figure 11: Transducer Numbers Drop-Down List

Table 4: Transducer Numbers Available

WETTED			CLAMP-ON			
SPECIAL	64		SPECIAL	23 (Shear)	113 (Shear)	307 (Shear)
40	52	65	1 (Rayleigh)	24 (Shear)	114 (Shear)	308 (Shear)
41	53	66	2 (Rayleigh)	25 (Shear)	115 (Shear)	309 (Shear)
42	54	67	3 (Rayleigh)	26 (Shear)	116 (Shear)	310 (Shear)
43	55	68	10 (Shear)	27 (Shear)	117 (Shear)	311 (Shear)
44	56	69	10 (Shear)	28 (Shear)	125 (Shear)	312 (Shear)
45	57	70	11 (Shear)	29 (Shear)	126 (Shear)	313 (Shear)
46	58	71	12 (Shear)	30 (Shear)	127 (Shear)	314 (Shear)
47	59	72	13 (Shear)	31 (Shear)	133 (Shear)	315 (Shear)
48	60	73	14 (Shear)	32 (Shear)	136 (Shear)	401 (Shear)
49	61	74	15 (Shear)	33 (Shear)	137 (Shear)	402 (Shear)
50	62	75	16 (Shear)	34 (Shear)	139 (Shear)	403 (Shear)
51	63	76	17 (Shear)	35 (Shear)	301 (Shear)	407 (Shear)
			18 (Shear)	36 (Shear)	302 (Shear)	408 (Shear)
			19 (Shear)	37 (Shear)	303 (Shear)	409 (Shear)
			20 (Shear)	38 (Shear)	304 (Shear)	410 (Shear)
			21 (Shear)	39 (Shear)	305 (Shear)	
			22 (Shear)	112 (Shear)	306 (Shear)	

3.2.1 Parameters for Special Transducers

Note: *The factory will supply the information required below with the transducers.*

3. The prompt asks for the transducer frequency, to transmit a signal at a frequency to which the transducer can respond.
 - a. From the Transducer prompt, press the [▼] key to reach the Frequency prompt, and press [ENTER].
 - b. A drop-down list of five frequencies opens, ranging from 0.50 to 4.00 MHz. Scroll to the desired frequency, and press [ENTER].
4. The next prompt asks for Tw, the time delay. This parameter is actually the time the transducer signal spends travelling through the transducer and cable. The PT878 calculates the flow rate from the upstream and downstream transit times in the fluid, so the Tw (time delay) must be subtracted out for an accurate measurement. The factory supplies the time delay on a sheet of paper inside the transducer case.
 - a. From the Frequency prompt, press the [▶] key to reach the Tw prompt, and press [ENTER].
 - b. Use the numeric keys to enter the GE-supplied time delay and press [ENTER].

The program now varies, depending on whether you have selected a wetted or a clamp-on transducer.

- If you have selected a special wetted transducer, proceed to *Confirming Entries* on page 30.
 - Special clamp-on transducers require three more inputs: wedge angle, wedge temperature, and wedge soundspeed.
5. When calculating the flow rate, the PT878 must take into account the wedge angle, the angle of the ultrasonic transmission.
 - a. From the Tw prompt, press the [▼] key to reach the Wedge Angle prompt, and press [ENTER].
 - b. Use the numeric keys to enter the factory-supplied wedge angle (in degrees) and press [ENTER].

3.2.1 Parameters for Special Transducers (cont.)

Note: *If the error message in Figure 12 below, or one similar to Figure 13 on page 28 appears, the Pipe Soundspeed, Wedge Soundspeed, and/or the Wedge Angle may be in error. Review the pipe and wedge parameters currently entered and change one or more as necessary.*

Note: *To change pipe information, see Entering Pipe Parameters on page 30.*

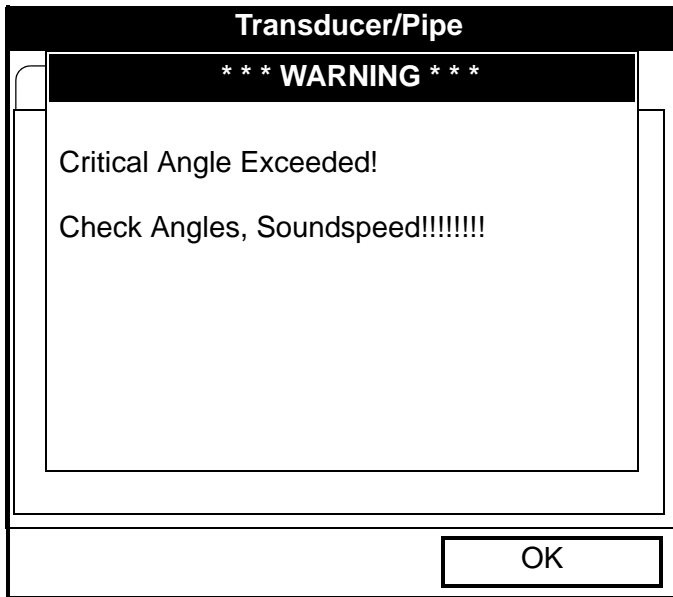

Figure 12: High Angle Error Message Window

3.2.1 Parameters for Special Transducers (cont.)

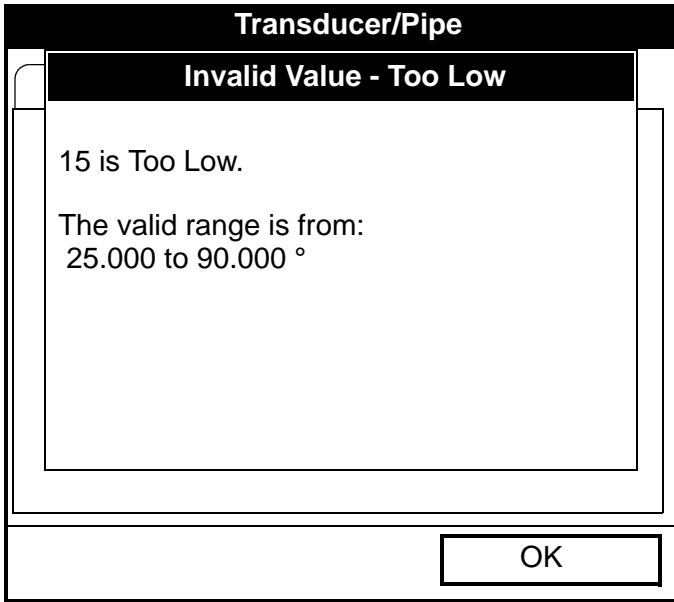

Figure 13: Low Angle Error Message Window

Note: *When the corrected information is entered, a message similar to Figure 14 appears. Press [F3] (OK).*

3.2.1 Parameters for Special Transducers (cont.)

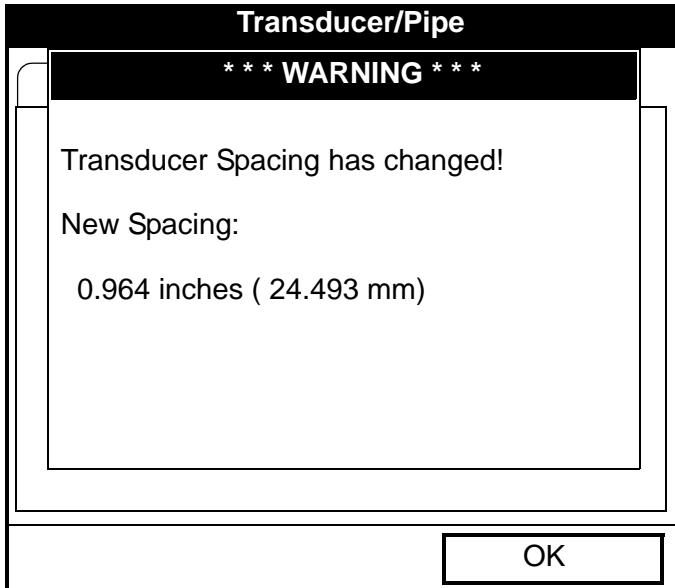

Figure 14: Transducer Spacing Change Window

6. The PT878 must also take into account the wedge temperature.
 - a. From the Wedge Angle prompt, press the [▼] key to reach the Wedge Temperature prompt, and press [ENTER].
 - b. Use the numeric keys to enter the wedge temperature (in degrees F or C) and press [ENTER].
7. Finally, the PT878 requires the wedge soundspeed.
 - a. From the Wedge Temp prompt, press the [▼] key to reach the Wedge SS prompt, and press [ENTER].
 - b. Use the numeric keys to enter the factory-supplied wedge soundspeed (in ft/sec or m/sec) and press [ENTER].

Pressing the [▼] key returns the meter to the Transducer tab at the top.

3.2.2 Confirming Entries

- To confirm the entries and return to Operate mode, press [F3] (OK).
- To leave the window without confirming the entries, press [F2] (Cancel) or the [ESC] key.

In either case, the PT878 returns to Operate Mode.

3.3 Entering Pipe Parameters

To enter the Pipe option, scroll to the Pipe entry on the Program Menu and press [ENTER]. (From the Transducer window, you can scroll back up to the Transducer tab and press the [▶] arrow key to reach the Pipe window, and press [ENTER].) The screen appears similar to Figure 15 below. To step through each parameter, press the [▼] key. Refer to Figure 139 on page 222 of Appendix A, *Menu Maps*.

Note: Refer to the brochure *Soundspeeds and Pipe Size Data (914-004)* for additional information about pipe sizes and soundspeeds.

The screenshot shows a window titled "Transducer/Pipe" with five tabs: "Transducer", "Pipe" (selected), "Lining", "Fluid", and "Path". The "Pipe" tab contains the following fields and options:

- Material: Other
- Sound Speed: 600.3 m/s
- Measure Wall with TGauge: (checkbox)
- OD, mm: 5
- OD x PI, mm: 15.708
- Wall, mm: 2
- Nominal: (checkbox)
- Schedule: (checkbox)
- ANSI: (checkbox)

At the bottom of the window are two buttons: "Cancel" and "OK".

Figure 15: Pipe Option Window

3.3 Entering Pipe Parameters (cont.)

1. The first prompt asks you to select the pipe material.
 - a. Press [ENTER] to enter the material prompt.
 - b. A drop-down list of materials opens. Table 5 below lists the available preprogrammed materials on the list. Press the [▼] or [▲] keys to scroll to the appropriate material, or scroll to “Other” for a material not on the list. You can press the [▶] key to scroll down by a page, or the [◀] key to scroll up by a page.

Table 5: Preprogrammed Pipe Materials

Pipe Material Category	Specific Material
Al - Aluminum	Rolled
Brass	None
Cu - Copper	Annealed or Rolled
CuNi - Copper/Nickel	70% Cu 30% Ni or 90% Cu 10% Ni
Glass	Pyrex, Flint, or Crown
Gold	Hard-drawn
Inconel	None
Iron	Armco, Ductile, Cast, Electrolytic
Monel	None
Nickel	None
Plastic	Nylon, Polyethylene, Polypropylene, PVC (CPVC), or Acrylic
Steel	Carbon Steel or Stainless Steel
Tin	Rolled
Titanium	None
Tungsten	Annealed, Carbide, Drawn
Zinc	Rolled
Other*	Any material

- c. Press [ENTER] to confirm the choice.

3.3 Entering Pipe Parameters (cont.)

- d. If you have selected “Other,” the meter prompts you to enter the soundspeed. Use the numeric keys to type the desired soundspeed in the text box, and press [ENTER] to confirm the choice.

Note: *If the “Other” Pipe soundspeed entered is too large, given the previously entered Wedge soundspeed and angles, an error message similar to Figure 16 below will appear. Press [F3] (OK) (the error message disappears), and enter another soundspeed within the range specified.*

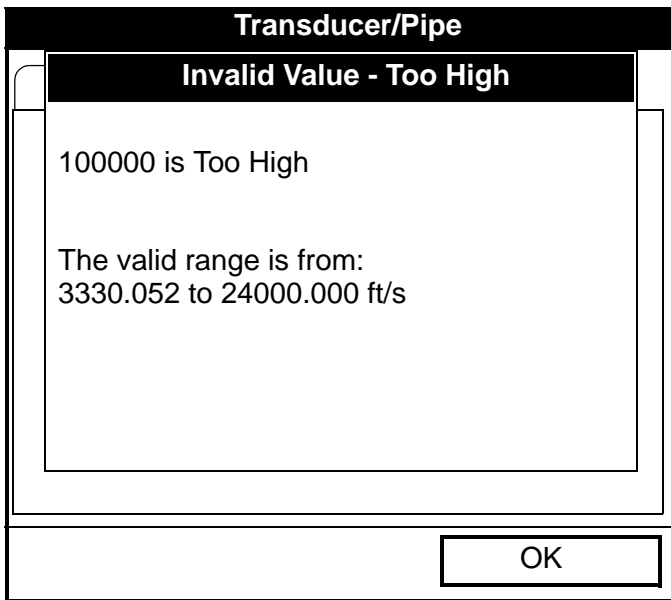

Figure 16: Soundspeed Error Message Window

Note: *When the corrected soundspeed is entered, a message similar to Figure 17 on page 33 appears. Press [F3] (OK).to return to the Site Menu.*

3.3 Entering Pipe Parameters (cont.)

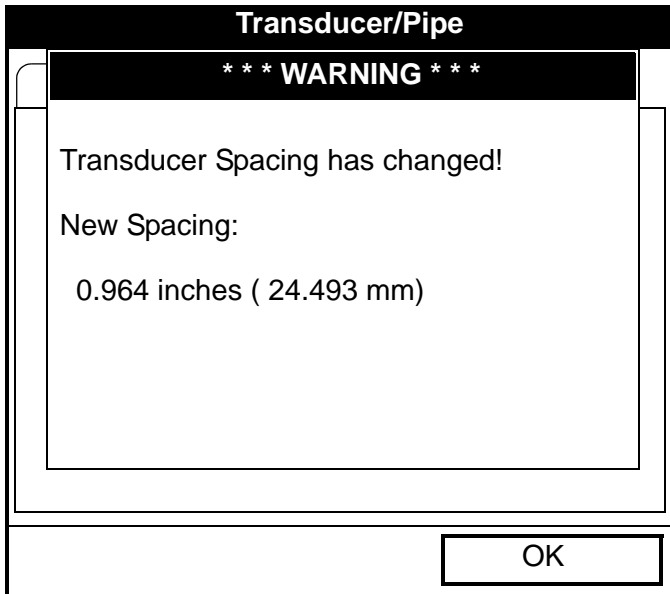

Figure 17: Transducer Spacing Change Window

2. The next prompt asks if you wish to measure the pipe wall with the internal thickness gauge. If you press [ENTER], the program moves to the T-Gauge Display option (as covered on page 162). When you have completed setting up and using the thickness gauge (as discussed in Chapter 8), press [F2] or [F3] to return to the Pipe tab.
3. For pipe diameter, two alternatives are available. At the Diameter prompt, the meter asks for the pipe outside diameter and thickness. But if you have selected certain pipe materials (carbon or stainless steel, cast iron, PVC and CPVC), you have the option of entering the pipe dimensions by a standardized schedule. Once you enter the nominal pipe size and identification, the PT878 determines the OD and wall thickness from an internal table.

3.3 Entering Pipe Parameters (cont.)

If you select a material that uses the Diameter alternative:

- a. You must select from two choices, outside diameter or circumference.
 - The prompt moves to the OD (outside diameter) text box. Type the thickness (in mm or in.) into the text box, and press [ENTER] to confirm the choice, or
 - Move the prompt to the OD X PI (circumference) text box. Type the OD (in mm or in.) into the box, and press [ENTER] to confirm your choice.
- b. In either case, the next prompt asks for the wall thickness. Type the value (in mm or in.) into the box, and press [ENTER] to confirm your choice.

Note: *The measurement units shown depend on the choices you have made in the English/Metric window or the Meter Settings menu.*

If you select a material that has the Schedule option:

- a. The prompt asks if you wish to apply ANSI (the ANSI schedule). Press [ENTER] to select (or deselect) the ANSI box. (If you do not select the ANSI option, the prompt moves to the OD text box, and you enter the parameters for the Diameter alternative as discussed above.)
- b. Press the [◀] key twice to move the prompt to the Nominal pipe size drop-down menu. Press [ENTER] to open the menu. Scroll to the desired pipe size, and press [ENTER] to confirm your choice.
- c. Press the [▶] key to move the prompt to the Schedule drop-down menu. Press [ENTER] to open the menu. Scroll to the desired schedule, and press [ENTER] to confirm the choice.

After entering either diameter or schedule settings, pressing the [▲] key returns the meter to the Pipe Material prompt.

3.3 Entering Pipe Parameters (cont.)

- To confirm the entries and return to Operate Mode, press [F3] (OK).
- To leave the window without confirming the entries, press [F2] (Cancel) or the [ESC] key.

In either case, the PT878 returns to Operate Mode.

- To return to the Pipe tab and scroll to other windows, press the [▲] key.

3.4 Entering Pipe Lining Parameters

To enter the Lining option, scroll to the Lining entry on the Program Menu and press [ENTER]. (From the Pipe window, you can scroll back up to the Pipe tab and press the [▶] arrow key to reach the Lining window, and press [ENTER].) The screen appears similar to Figure 18 below. To step through each parameter, press the [▼] key. While programming, refer to Figure 144 on page 228 of Appendix A, *Menu Maps*.

Note: *The Lining option is only available for clamp-on transducers.*

The screenshot shows a window titled "Transducer/Pipe" with five tabs: "Transducer", "Pipe", "Lining", "Fluid", and "Path". The "Lining" tab is selected. The window contains the following parameters:

- Material: Tar/Epoxy
- Sound Speed: 2000 m/s
- Thickness: 0 mm

At the bottom of the window are two buttons: "Cancel" and "OK".

Figure 18: Pipe Lining Window

3.4 Entering Pipe Lining Parameters (cont.)

1. The PT878 first prompts you to select the pipe lining material.
 - a. Press [ENTER] to open the drop-down list of lining materials.
 - b. Scroll to the appropriate material. If you do not see your lining material on the list, select “Other.”
 - c. Press [ENTER] to confirm your choice.

Note: *If your pipe lining is not on the drop-down list, consult the factory for further information.*

2. The menu now follows one of two paths:
 - If you have selected a preprogrammed material, the PT878 automatically supplies the correct soundspeed, and you can proceed to step 3.
 - If you have selected “Other,” the meter prompts you to enter the soundspeed. Use the numeric keys to type the desired soundspeed in the text box, and press [ENTER] to confirm the choice.
3. The meter now asks for the lining thickness. Use the numeric keys to enter the desired value in the text box, and press [ENTER] to confirm your entry.

Pressing the [▼] key returns the meter to the Lining tab.

- To confirm the entries and return to Operate Mode, press [F3] (OK). The PT878 returns to Operate Mode.
- To leave the window without confirming the entries, press [F2] (Cancel) or the [ESC] key. The PT878 returns to Operate Mode.
- To scroll to other windows, press the [◀] or [▶] key. Your changes will remain until you select OK or Cancel from one of the tabbed windows in the Transducer/Pipe form.

3.5 Entering Fluid Types and Speeds

To access the Fluid option, scroll to the Fluid entry on the Program Menu and press [ENTER]. (If you are already in the Transducer/Pipe form, press the [▶] arrow key to reach the Fluid window, and press [ENTER].) The screen appears similar to Figure 19 below. To step through each parameter, press the [▼] key. Refer to Figure 145 on page 229 of Appendix A, *Menu Maps*.

Transducer/Pipe

Transducer Pipe Lining **Fluid** Path

Tracking Windows? No Yes

Fluid

Sound Speed m/s

Speed Min m/s

Speed Max m/s

Temp °F Glycol %

Figure 19: Fluid Type Window

1. The first prompt asks you to select whether or not you want Tracking Windows. These windows are used to detect the receive signal when you are unsure of the fluid soundspeed. (Default operation is “No.”)
 - a. Use the [◀] and [▶] keys to scroll to the appropriate radio button.
 - b. Press [ENTER] to confirm your selection.

3.5 Entering Fluid Types and Speeds (cont.)

2. Next, you must select the fluid type.
 - a. Press [ENTER] to open the drop-down menu. Table 6 below lists the available choices, which vary with your selection of Tracking Windows or the Energy option.

Table 6: Fluid Type Selection

	Tracking Windows Off	Tracking Windows On
Energy Off	Other	Water (0-260°C)
	Water (0-260°C)	Oil
	Sea Water	Other
	Oil (22°C)	
	Crude Oil	
	Lube Oil (X200)	
	Methanol	
	Ethanol	
	LN2 (-199°C)	
	Freon (R-12)	
Energy On	Water/0-260°C	Water/0-260°C
	Water/Glycol (with glycol percentage)	Water/Glycol (with glycol percentage)
	Other (with single soundspeed)	Other (with minimum and maximum soundspeeds)

- b. Scroll to the appropriate fluid. If you do not see your fluid on the list, select “Other.”

Note: Depending on your selection, additional prompts may appear, as specified in Table 6 above.

- c. Press [ENTER] to confirm your selection.

At the end of any sequence, pressing the [▼] key returns you to the Tracking Windows prompt.

- To confirm the entries and return to Operate Mode, press [F3] (OK). The PT878 returns to Operate Mode.
- To leave the window without confirming the entries, press [F2] (Cancel) or the [ESC] key. The PT878 returns to Operate Mode.
- To scroll to other windows, press the [◀] or [▶] key.

3.6 Entering the Signal Path Parameters

To enter the Path option, scroll to the Path entry on the Program Menu and press [ENTER]. (From the Lining window, you can scroll back up to the Lining tab and press the [▶] arrow key to reach the Path window, and press [ENTER].) The screen appears similar to Figure 20 below. To step through each parameter, press the [▼] key. Refer to Figure 146 on page 230 of Appendix A, *Menu Maps*.

The screenshot shows a window titled "Transducer/Pipe" with four tabs: "Transducer", "Pipe", "Lining", and "Path". The "Path" tab is selected. The window contains the following parameters and values:

Path Length	<input type="text" value="248.92"/>	mm
Axial Length	<input type="text" value="203.2"/>	mm
Traverses	<input type="text" value="1"/>	
Spacing	<input type="text" value="90"/>	mm

At the bottom of the window are two buttons: "Cancel" and "OK".

Figure 20: Signal Path Window

The prompts available for the Path option depend on whether you have selected clamp-on or wetted transducers in the Transducer menu. (If the PT878 does not scroll to a particular parameter, it is not necessary for that transducer type.)

3.6.1 Path Parameters for Clamp-On Transducers

Note: *For wetted transducers, go to page 41.*

If you are using clamp-on transducers, the PT878 path menu includes two parameters:

- Traverses
 - Spacing
1. The PT878 first prompts for traverses, the number of times the ultrasonic signal crosses the pipe (see the *Liquid Transducer Installation Guide* (916-055) for more details).
 - a. Press [ENTER] to open the drop-down list of traverse numbers.
 - b. Scroll to the appropriate number.
 - c. Press [ENTER] to confirm the entry.
 2. The next prompt displays the spacing of the transducers, as calculated from the information entered.
 - a. Record this number and use it to space the transducers. (Use the *Liquid Transducer Installation Guide* (916-055) to assist in installing transducers on the pipe.) Press the [▼] key to scroll to the next parameter.
 - b. If necessary, you can overwrite the spacing to match the actual physical spacing of the transducers. (Do not change the spacing by more than $\pm 10\%$ from that calculated by the meter.) Use the numeric keys to enter the desired value, and press [ENTER] to confirm the entry. If you have entered an invalid entry, the PT878 rejects the entry and displays an error message.
- Note:** *It is not recommended that you use a spacing other than the one calculated by the PT878.*

After you enter the spacing, pressing the [▲] key returns the prompt to the Traverses box, and then to the Path tab at the top of the screen.

3.6.2 Path Parameters for Wetted Transducers

If you are using wetted transducers, the PT878 path menu includes the following set of parameters:

- Path Length
 - Axial Length
1. The meter first prompts for the path length (P) of the ultrasonic signal. GE has calculated the path length based on the transducer configuration for your particular application. Find the path length on the flowcell or on other supplied documentation.
 - a. Press [ENTER] to enter the text box.
 - b. Use the numeric keys to enter the appropriate number.
 - c. Press [ENTER] to confirm the entry.

Note: *If the documentation does not supply the path or axial lengths, refer to Appendix B, Measuring P and L Dimensions, to measure these lengths.*

2. The next prompt asks for the axial dimension (L) of the ultrasonic signal. Again, GE has calculated the axial dimension based on the transducer configuration for your particular application. Find the axial dimension on the flowcell or from other supplied documentation.
 - a. Press [ENTER] to enter the text box.
 - b. Use the numeric keys to enter the appropriate number.
 - c. Press [ENTER] to confirm the entry.

After you enter the axial length, press the [▲] key to return to the main Path tab at the top of the screen.

- To confirm the entries and return to Operate Mode, press [F3] (OK). The PT878 returns to Operate Mode.
- To leave the window without confirming the entries, press [F2] (Cancel) or the [ESC] key. The PT878 returns to Operate Mode.
- To scroll to other windows, press the [◀] or [▶] key.

3.7 Entering the Energy Option Parameters

The Energy Option enables you to calculate the energy of a system based on the temperature at a supply point, the temperature at a return point, and the flow of fluid through the system. To enter the Energy Option, scroll to the Energy entry on the Program Menu and press [ENTER]. The screen appears similar to Figure 21 below. To step through each parameter, press the [▼] key. While programming, refer to Figure 147 on page 231 of Appendix A, *Menu Maps*.

The screenshot shows a window titled "Energy Options" with three tabs: "Energy Option", "Inputs", and "Custom Cp". The "Energy Option" tab is selected. The window contains the following settings:

- Energy:** Disabled, Enabled
- System:** Heating, Cooling
- Flow Measurement at:** Supply, Return
- Calculation Method:** Standard, Custom Cp

At the bottom of the window are two buttons: "Cancel" and "OK".

Figure 21: Energy Option Window

1. The first prompt asks if you want to disable or enable the Energy Option.
 - a. Use the [◀] and [▶] keys to scroll to the appropriate radio button.
 - b. Press [ENTER] to confirm your selection.

Note: *If you select "Disabled," you cannot select any other prompt in this window.*

3.7 Entering the Energy Option Parameters (cont.)

2. The next prompt asks if you are using a heating or cooling system.
 - a. Use the [◀] and [▶] keys to scroll to the appropriate radio button.
 - b. Press [ENTER] to confirm your selection.
3. The program now asks if you are measuring flow at the point of supply or return.
 - a. Use the [◀] and [▶] keys to scroll to the appropriate radio button.
 - b. Press [ENTER] to confirm your selection.
4. The final prompt asks if you wish to use the standard or Custom Cp method for energy calculations. If you choose Custom Cp, you must enter tables for fluid enthalpy and density in the Custom Cp tab (see page 46).
 - a. Use the [◀] and [▶] keys to scroll to the appropriate radio button.
 - b. Press [ENTER] to confirm your selection.

Pressing the [▲] key returns the meter to the Energy prompt, and then to the Energy Option tab.

- To confirm the entries and return to Operate mode, press [F3] (OK). The PT878 returns to Operate Mode.
- To leave the window without confirming the entries, press [F2] (Cancel) or the [ESC] key. The PT878 returns to Operate Mode.

3.7.1 Entering Inputs in the Energy Option

To enter input parameters in the Energy Option, return to the Energy Option tab at the top of the Energy Option window. Press the [▶] arrow key to reach the Inputs window, and press [ENTER]. The screen appears similar to Figure 22 below. To step through each parameter, press the [▼] key.

Important: *The supply and return must be on separate inputs.*

The screenshot shows a window titled "Energy Options" with three tabs: "Energy Option", "Inputs", and "Custom Cp". The "Inputs" tab is selected. The window contains the following controls:

- Supply:** Two radio buttons, "Fixed" (unselected) and "Active" (selected).
- Temp:** A text input field containing an empty box followed by "°C".
- Input #:** A text input field containing "A".
- T Return:** Two radio buttons, "Fixed" (selected) and "Active" (unselected).
- Temp:** A text input field containing "90" followed by "°C".
- Input #:** A text input field containing "B".

At the bottom of the window are two buttons: "Cancel" and "OK".

Figure 22: Inputs Tab in the Energy Option

1. The first prompt asks if the temperature supply is fixed or active.
 - a. Use the [◀] and [▶] keys to scroll to the appropriate radio button.
 - b. Press [ENTER] to confirm your selection.

3.7.1 Entering Inputs in the Energy Option (cont.)

2. The next prompt depends on whether you have selected a fixed or an active supply.
 - If you have selected a fixed supply, the PT878 asks for the desired temperature. Use the numeric keys to enter the desired temperature (in degrees C), and press [ENTER] to confirm the entry.
 - If you have selected an active supply, the PT878 asks for the desired input.
 - a. Press [ENTER] to open the drop-down menu.
 - b. Scroll to Input A or B.
 - c. Press [ENTER] to confirm the entry.
3. The next prompt asks if the temperature return is fixed or active.
 - a. Use the [◀] and [▶] keys to scroll to the appropriate radio button.
 - b. Press [ENTER] to confirm your selection.
4. The next prompt depends on whether you have selected a fixed or an active return.
 - If you have selected a fixed return, the PT878 asks for the desired temperature. Use the numeric keys to enter the desired temperature (in degrees C), and press [ENTER] to confirm the entry.
 - If you have selected an active return, the PT878 asks for the desired input.
 - a. Press [ENTER] to open the drop-down menu.
 - b. Scroll to Input A or B.
 - c. Press [ENTER] to confirm the entry.

Note: *If either input is fixed, the analog input(s) not used by the Energy Option can act as general-purpose inputs.*

Pressing the [▼] key returns the meter to the Inputs tab.

3.7.1 Entering Inputs in the Energy Option (cont.)

- To confirm the entries and return to Operate mode, press [F3] (OK). The PT878 returns to Operate Mode.
- To leave the window without confirming the entries, press [F2] (Cancel) or the [ESC] key. The PT878 returns to Operate Mode.

To enter data for Custom Cp calculations, proceed to the Custom Cp tab, discussed on page 46.

3.7.2 Entering Custom Cp Data in the Energy Option

To program Custom Cp tables in the Energy Option, return to the tabs at the top of the Energy Option window. Press the [▶] arrow key until you have highlighted the Custom Cp tab, and press [ENTER]. The screen appears similar to Figure 23 below. To step through each parameter, press the [▼] key.

The screenshot shows a window titled "Energy Options" with three tabs: "Energy Option", "Inputs", and "Custom Cp". The "Custom Cp" tab is selected and highlighted. The main area contains the following elements:

- "Custom Cp" label with an "Edit Table" button to its right.
- "Density Source" label with two radio buttons: "Fixed" (unselected) and "Table" (selected).
- "Static Density" label with an empty text input field to its right.
- "Density Table" label with an "Edit Table" button to its right.

At the bottom of the window, there are two buttons: "Cancel" and "OK".

Figure 23: Custom Cp Tab in the Energy Option

3.7.2 Entering Custom Cp Data in the Energy Option (cont.)

1. The first prompt asks if you wish to enter or edit data in the Custom Cp (enthalpy) table.
 - a. Press [ENTER] to open the Custom Cp table, shown in Figure 24 on page 47.
 - b. Use the numeric keys to enter the desired temperature in degrees Kelvin, and press [ENTER] to confirm the entry.
 - c. Press the [▶] key to move to the kJ/kg/°K column (enthalpy in KiloJoules/Kilogram/°Kelvin). Use the numeric keys to enter the desired value, and press [ENTER].

Custom Cp		
	°Kelvin	kJ/kg/°K
1		
2		
3		
4		
5		
<input type="button" value="Cancel"/>		<input type="button" value="OK"/>

Figure 24: Custom Cp (temperature vs. enthalpy) Table

- d. Repeat steps b and c for the remainder of the table.
- e. When you have completed entering values, press [F3] (OK) to confirm the table and return to the Custom Cp window.

3.7.2 Entering Custom Cp Data in the Energy Option (cont.)

2. The next prompt asks from which source — a fixed value or table — the PT878 will use for fluid density values. Use the [◀] and [▶] keys to scroll to the appropriate radio button, and press [ENTER].
3. The menu now varies, depending on your selection in step 2.
 - If you selected “Fixed,” the PT878 asks for the fixed fluid density. Use the numeric keys to enter the desired value, and press [ENTER].
 - If you selected “Table,” the meter highlights the “Edit Table” button.

Edit Density		
	°Kelvin	kg/m ³
1		
2		
3		
4		
5		
Cancel		OK

Figure 25: Fluid Density Table

- a. Press [ENTER] to open the Edit Density table, shown in Figure 25 above.
- b. Use the numeric keys to enter the desired temperature in degrees Kelvin, and press [ENTER].
- c. Press the [▶] key to move to the kg/m³ column (density in Kilogram/cubic meters). Use the numeric keys to enter the desired value, and press [ENTER].

3.7.2 Entering Custom Cp Data in the Energy Option (cont.)

- d. Repeat steps b and c for the remainder of the table.
- e. When you have completed entering up to 20 values, press [F3] (OK) to confirm the table and return to the Custom Cp window.
- To confirm the entries and return to Operate mode, press [F3] (OK). The PT878 returns to Operate Mode.
- To leave the window without confirming the entries, press [F2] (Cancel) or the [ESC] key. The PT878 returns to Operate Mode.

3.8 Entering Analog Inputs

The Analog Input option enables you to specify parameters for general purpose or energy inputs. To enter the Inputs option, scroll to the Analog Input entry on the Program Menu and press [ENTER]. If you have not enabled the Energy Option (see page 42), the screen appears similar to Figure 26 below. To step through each parameter, press the [▼] key. Refer to Figure 148 on page 232 of Appendix A, *Menu Maps*.

3.8.1 Entering General-Purpose Analog Inputs

The screenshot shows a window titled "Analog Input" with two tabs, "Input A" and "Input B". The "Input A" tab is selected. The window contains the following fields and values:

Function	General Purpose
Label	Inlet Temp
Units	*C
Zero	0 °C
Span	100 °C

At the bottom of the window are two buttons: "Cancel" and "OK".

Figure 26: Analog Inputs Option Window

1. The first prompt asks you to select whether the desired function is off or general purpose.
 - a. Press [ENTER] to open the drop-down menu.
 - b. Scroll to the desired response.
 - c. Press [ENTER] to confirm your selection.

3.8.1 Entering General-Purpose Analog Inputs (cont.)

2. The next prompt asks if you want to label the input.
 - a. Press [ENTER] to enter the text box. The text creation window appears, as shown in Figure 27 below.

A	B	C	D	E	F	G	H	I	J
K	L	M	N	O	P	Q	R	S	T
U	V	W	X	Y	Z	0	1	2	3
4	5	6	7	8	9	.	,	"	'
=	<	>							
Delete			Cancel			OK			

Figure 27: Text Creation Window

- b. Use the four arrow keys to scroll to the desired letter or symbol, and press [ENTER] to add the letter to the name.

Note: *Pressing [SEL] causes the screen to show successively a set of upper-case (capital) letters, a set of lower-case letters, and a set of symbols. Use all three screens to create a desired label.*

- c. Repeat this procedure for each letter or symbol you wish to add to the name. If you wish to delete a letter, press [F1] (Delete) to erase each letter or symbol, from right to left on the label.
- d. When you have completed the label, press [F3] (OK) to confirm the label, or [F2] (Cancel) to leave the window without adding the label.

3.8.1 Entering General-Purpose Analog Inputs (cont.)

3. The next prompt asks you to create a label for the units, if desired. (This label will appear to the right of the zero and span value boxes.) Press [ENTER] to reopen the text creation window, and follow the same steps covered in Step 2 on page 51.
4. The next prompt asks for the zero input value.
 - a. Press [ENTER] to enter the text box.
 - b. Use the numeric keys to enter the desired value.
 - c. Press [ENTER] to confirm the entry.
5. The final prompt asks for the span input value.
 - a. Press [ENTER] to enter the text box.
 - b. Use the numeric keys to enter the desired value.
 - c. Press [ENTER] to confirm the entry.

You have completed entering data for general-purpose inputs.

3.8.2 Entering Analog Inputs in the Energy Option

If you have enabled the Energy Option, the screen displays fewer options, as shown in Figure 28 below.

The screenshot shows a window titled "Analog Input" with two tabs: "Input A" and "Input B". The "Input A" tab is selected. Inside the window, there are five input fields:

- Function: Supply Temp
- Label: Supply Temp
- Units: °C
- Zero: 0 °C
- Span: 100 °C

At the bottom of the window, there are two buttons: "Cancel" and "OK".

Figure 28: Analog Inputs Option Window - Energy Option Activated

3.8.2 Entering Analog Inputs in the Energy Option (cont.)

The screen displays the function (supply or return temperature), label (supply or return temperature) and units selected in the Inputs form of the Energy Option (see page 44). You cannot change these parameters in this form. Press the [▼] key to step through these parameters.

1. The first prompt asks for the zero input value.
 - a. Press [ENTER] to enter the text box.
 - b. Use the numeric keys to enter the desired value.
 - c. Press [ENTER] to confirm the entry.
2. The final prompt asks for the span input value.
 - a. Press [ENTER] to enter the text box.
 - b. Use the numeric keys to enter the desired value.
 - c. Press [ENTER] to confirm the entry.

You have completed entering parameters in the Analog Inputs option.

- To confirm the entries and return to Operate mode, press [F3] (OK). The PT878 returns to Operate Mode.
- To leave the window without confirming the entries, press [F2] (Cancel) or the [ESC] key. The PT878 returns to Operate Mode.

3.9 Entering the Analog Output

The Analog Output option enables you to enter information to set up output parameters. To enter the option, scroll to the Analog Output entry on the Program Menu and press [ENTER]. The screen appears similar to Figure 29 below. To step through each parameter, press the [▼] key. Refer to Figure 149 on page 233 of Appendix A, *Menu Maps*.

Analog Output	
Function	0-20 mA
Data Source	Velocity Meters/sec
Zero	0 m/s
Span	25.5 m/s
On Error	Hold Last Value
Cancel OK	

Figure 29: Analog Output Window

1. The first prompt enables you to select a range to send a current signal to a recording device.
 - a. Press [ENTER] to open the drop-down menu.
 - b. Scroll to the desired output from three choices: Off, 0-20 mA, and 4-20 mA.
 - c. Press [ENTER] to confirm your selection.

Note: *If you select “Off,” you will not be able to access any other parameters in this option.*

3.9 Entering the Analog Output (cont.)

2. The next prompt asks you to select the analog output type from a list of choices, as shown in Figure 30 below.

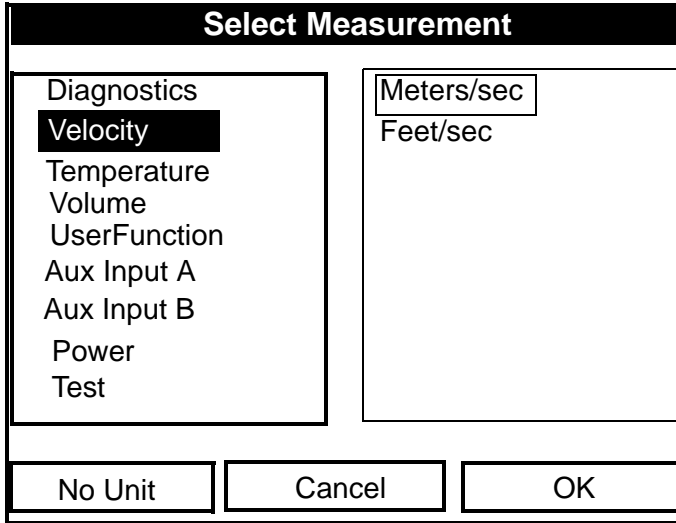

Figure 30: Data Source Selection Window

- a. Press [ENTER] to open the window.
- b. Scroll to the desired output type.
- c. Press [SEL] to confirm your selection.
- d. The prompt then moves to a list of unit types. (The available units depend on the selection made at the Data Source prompt.) Scroll to the desired output unit.
- e. Press [F3] (OK) to confirm your selection.

3.9 Entering the Analog Output (cont.)

3. The next prompt asks you to enter the zero (base) value for the analog output. This value represents the 0/4 mA output (in flow units).
 - a. Press [ENTER] to open the text box.
 - b. Use the numeric keys to enter the desired value.
 - c. Press [ENTER] to confirm your selection.
4. The next prompt asks you to enter the span (full scale) value for the analog output. This value represents the 20 mA output (in flow units).
 - a. Press [ENTER] to open the text box.
 - b. Use the numeric keys to enter the desired value.
 - c. Press [ENTER] to confirm your selection.
5. The last prompt, On Error, asks you to select how the PT878 will handle the analog outputs in the event of a fault condition. The meter offers three alternatives:
 - Hold Last Value (hold the last good reading)
 - Force Low (force the reading to 0 or 4 mA)
 - Force High (force the reading to 20 mA).
 - a. Press [ENTER] to open the drop-down menu.
 - b. Scroll to the desired selection.
 - c. Press [ENTER] to confirm your selection.

You have completed entering data in the Analog Output option.

- To confirm the entries and return to Operate mode, press [F3] (OK). The PT878 returns to Operate Mode.
- To leave the window without confirming the entries, press [F2] (Cancel) or the [ESC] key. The PT878 returns to Operate Mode.

3.10 Entering the Digital Output

While resembling the Analog Output option, the Digital Output option enables you to set up parameters necessary for a digital output. To enter the option, scroll to the Digital Output entry on the Program Menu and press [ENTER]. The screen appears similar to Figure 31 below. To step through each parameter, press the [▼] key. While programming, refer to Figure 150 on page 234 of Appendix A, *Menu Maps*.

Digital Output	
Function	Pulse Totalizer
Data Source	Fwd Totalizer Fwd Gallons
Units/Pulse	10 gal
Pulse Width	10 μs
Polarity	Low to High
Cancel OK	

Figure 31: Digital Output Window

1. The first prompt enables you to select the output function from five choices:
 - Off
 - Pulse Totalizer
 - Frequency
 - Test Points
 - Gate Input

3.10 Entering the Digital Output (cont.)

- a. Press [ENTER] to open the drop-down menu.
- b. Scroll to the desired function.
- c. Press [ENTER] to confirm your selection.

Note: *If you select Off, you will not be able to access any other parameters in this option. If you select Test Points or Gate Input, the program goes at once to Step 4.*

2. The next prompt asks you to select the data source for the digital output. The choices vary with the function. For Pulse Totalizer (shown in Figure 31 on page 57, the available choices include:
 - Forward Totalizer
 - Reverse Totalizer
 - Forward Energy
 - Reverse Energy
 - a. Press [ENTER] to open the data source selection window, shown in Figure 30 on page 55.
 - b. Scroll to the desired source.
 - c. Press [SEL] to confirm your selection.
 - d. The prompt then moves to a list of unit types. (The available units depend on the selection made at the Data Source prompt.) Scroll to the desired output unit.
 - e. Press [F3] (OK) to confirm your selection.
3. The last set of parameters that appears depends on the selection you made at the Function prompt.

If you selected Pulse Totalizer:

The prompt asks for the units/pulse, the pulse width (in microseconds), and the polarity. (Figure 31 on page 57 illustrates a Digital Output window configured for the Pulse Totalizer function.) For the Units/Pulse and Pulse Width parameters:

3.10 Entering the Digital Output (cont.)

- a. Press [ENTER] to open the text box.
- b. Use the numeric keys to enter the desired value.
- c. Press [ENTER] to confirm your selection.

For Polarity:

- a. Press [ENTER] to open the drop-down menu.
- b. Scroll to the desired polarity, either Low to High or High to Low.
- c. Press [ENTER] to confirm your selection.

If you selected Frequency:

The prompt asks for the minimum and maximum frequencies and the duty cycle percentage. For each parameter:

- a. Press [ENTER] to open the text box.
- b. Use the numeric keys to enter the desired value.
- c. Press [ENTER] to confirm your selection.

If you entered Test Points:

The prompt asks for the window (trigger) type from two choices, transmit and receive. These two windows can be used to trigger an oscilloscope to look at the receive signal output on another channel.

- a. Press [ENTER] to open the drop-down menu.
- b. Scroll to the desired signal.
- c. Press [ENTER] to confirm your selection.

3.10 Entering the Digital Output (cont.)

If you entered Gate Input:

Note: *Gate Input is used to synchronize the totalizer with the meter calibration system (discussed on page 67). The gate stops and starts the meter totalizer, so that you can compare the totalizer figure with the measured volume of water in the weight tank.*

1. The prompt asks for the gate active.
 - a. Press [ENTER] to open the drop-down menu.
 - b. Scroll to the desired gate active, whether Contact Open or Contact Closed.
 - c. Press [ENTER] to confirm your selection.
2. The second prompt asks for the mode.
 - a. Press [ENTER] to open the drop-down menu.
 - b. Scroll to the desired mode, either Automatic or Manual.
 - c. Press [ENTER] to confirm your selection.

Stopwatch Totalizer

Through the Gate Input option, you can implement the Stopwatch Totalizer function to measure totals manually. To set up the Totalizer function:

1. At the Gate Active prompt, select Contact Open.
2. At the Mode prompt, select Manual, and press [ENTER]. (Selecting Automatic causes the totalizer to run continuously.)

The stopwatch icon (see page 19) appears in the system tray. To start or stop the function, press the minus (–) key on the keypad.

You have completed entering parameters in the Digital Output option.

- To confirm the entries and return to Operate mode, press [F3] (OK). The PT878 returns to Operate Mode.
- To leave the window without confirming the entries, press [F2] (Cancel) or the [ESC] key. The PT878 returns to Operate Mode.

3.11 Entering User Functions

User functions enable you to program mathematical equations on each measurement. You can also use any parameter in the meter to calculate a different parameter. To enter the User Functions option, scroll to the User Functions entry on the Program Menu and press [ENTER]. The screen appears similar to Figure 32 below. To step through each parameter, press the [▼] key. Refer to Figure 151 on page 235 of Appendix A, *Menu Maps*.

Set User Function

Function **User F1**

Label

Units Sym

Dec.

Delete Check Done

Figure 32: User Functions Window

1. The first prompt asks you to select the function number, 1 through 8.
 - a. Press [ENTER] to open the drop-down menu.
 - b. Scroll to the desired function number (User F1, User F2, etc.).
 - c. Press [ENTER] to confirm the entry.

3.11 Entering User Functions (cont.)

2. The next prompt asks you to create a label for the function. The label corresponds to the measurement type (i.e., velocity or temperature), while the units symbol corresponds to the measurement units (i.e., feet/sec or degrees F).
 - a. Press [ENTER] to open the text creation window, which appears similar to Figure 33 below.

A	B	C	D	E	F	G	H	I	J
K	L	M	N	O	P	Q	R	S	T
U	V	W	X	Y	Z	0	1	2	3
4	5	6	7	8	9	.	,	"	'
=	<	>							
<div style="display: flex; justify-content: space-around; margin-top: 10px;"> <div style="border: 1px solid black; padding: 5px 20px;">Delete</div> <div style="border: 1px solid black; padding: 5px 20px;">Cancel</div> <div style="border: 1px solid black; padding: 5px 20px;">OK</div> </div>									

Figure 33: Text Creation Window

- b. Use the four arrow keys to scroll to the desired letter or symbol, and press [ENTER] to add the letter to the label.
- Note:** *Pressing [SEL] causes the screen to alternate between a set of upper-case (capital) letters, a set of lower-case letters, and a set of symbols. Use all three screens to create a desired label.*
- c. Repeat this procedure for each letter or symbol you wish to add to the label. If you wish to delete a letter, press [F1] (Delete) to erase each letter or symbol, from right to left on the label.

3.11 Entering User Functions (cont.)

- d. When you have completed the label, press [F3] (OK) to confirm the label, or [F2] (Cancel) to leave the window without adding the label.
3. The next prompt asks for the Units Symbol.
 - a. Press [ENTER] to reopen the text creation window.
 - b. Repeat the procedure used for the Label (on page 62) to create the Units Symbol.
 - c. When you have completed the label, press [F3] (OK) to confirm the symbol, or [F2] (Cancel) to leave the window without adding the symbol.
4. The next prompt asks you to select the number of decimal places.
 - a. Press [ENTER] to open the drop-down menu.
 - b. Scroll to the desired number of decimal places, ranging from 0 to 4.
 - c. Press [ENTER] to confirm the entry.
5. The final prompt asks for the function itself.
 - a. Press [ENTER] to open the function creation window, which appears similar to Figure 34 on page 64.
 - b. Use the four arrow keys to scroll to the desired function or table, and press [ENTER] to confirm each entry. Use the numeric keys to enter numeric values. Press [F1] (Delete) to remove any mistaken or unwanted symbols or numbers.

Note: *Pressing [SEL] causes the screen to alternate between a set of symbols and functions and a list of user functions. Use both screens to create the desired function.*

3.11 Entering User Functions (cont.)

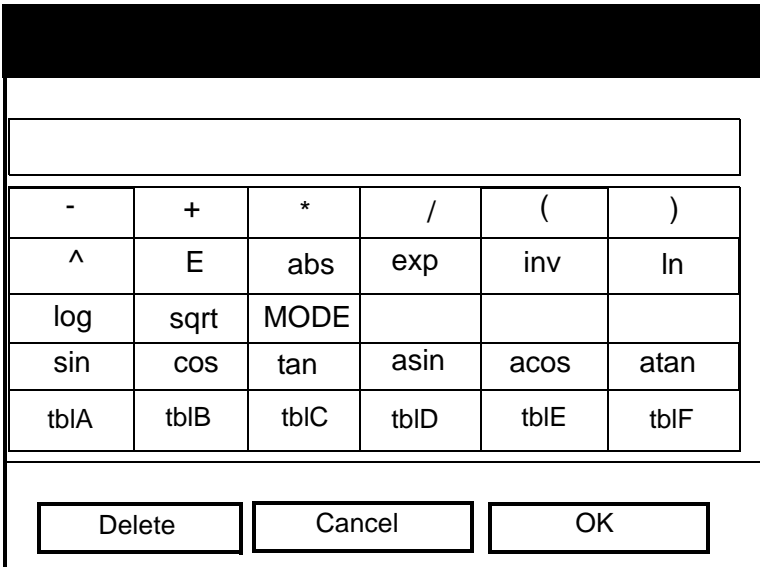

Figure 34: Function Creation Window

- c. To enter a particular measured parameter into the equation, click on the MODE symbol in the middle of the third row. The Data Source Selection window (shown in Figure 30 on page 55) opens. Select the desired data source and unit as discussed on page 55, and press [F3] (OK) to confirm the entry.
 - d. When you have completed entering the function, press [F3] (OK) to confirm the entry and return to the User Function window.
6. GE recommends pressing [F2] (Check) to test the validity of the function. The PT878 displays either “OK” or a message such as “Syntax Error.”
- Press [F1] to delete the entire function, or
 - Press [F3] (Done) to confirm the function and return to Operate Mode.

3.11.1 Entering Correction Factors

The final option in the Program Menu, Correction Factors, allows you to enter and modify three correction factors: Reynolds Correction, Kinematic Viscosity and Calibration Factor. To enter the Correction Factors option, scroll to the Correction Factors entry on the Program Menu and press [ENTER]. The screen appears similar to Figure 35 below. To step through each parameter, press the [▼] key. Refer to Figure 152 on page 236 of Appendix A, *Menu Maps*.

Correction Factors

Reynolds Correctio Calibration Factor

Re Correction On Off

K/V Factor Single Table

K/V (v) m³/s

Data Source

Edit Table

Cancel OK

Figure 35: Reynolds Correction Window

3.11.2 Entering Reynolds Correction

The default for Reynolds Correction is “On.” This correction factor should be on in most applications, including all those that utilize clamp-on transducers. It makes a small adjustment to the flow rate reported by the PT878, based on the Kinematic Viscosity. Reynolds Correction is necessary, as the velocity of the fluid measured along a diametrical path must be related to the total area average velocity over the entire pipe cross-section.

3.11.2 Entering Reynolds Correction (cont.)

1. The first prompt asks if you want to enable the Reynolds Correction factor, a number based on the Kinematic Viscosity and flow rate of the fluid.

Note: *If you are using clamp-on transducers, you should enable Reynolds Correction.*

- a. Use the [◀] and [▶] keys to scroll to the appropriate radio button.
- b. Press [ENTER] to confirm your selection.

Note: *If you disable Reynolds Correction, you will not be able to enter any other values in this window.*

2. If you enable Reynolds Correction, you will also need to enter the Kinematic Viscosity of the fluid (available in the brochure *Soundspeeds and Pipe Size Data*, 914-004). The prompt asks for a kinematic viscosity value.
 - a. Press [ENTER] to open the text box.
 - b. Use the numeric keys to enter the desired value (from *Soundspeeds and Pipe Size Data*).
 - c. Press [ENTER] to confirm your selection.

You have completed entering data for a single Kinematic Viscosity factor. Proceed to *Entering a Calibration Factor* on page 67.

- To confirm the entries and return to Operate Mode, press [F3] (OK). The PT878 returns to Operate Mode.
- To leave the window without confirming the entries, press [F2] (Cancel) or the [ESC] key.

3.11.3 Entering a Calibration Factor

The Calibration Factor is used to calibrate or adjust the readings of the PT878 to another flow reference. To enter a Calibration Factor, return to the Reynolds Correction tab at the top of the Correction Factors option. Press the [▶] arrow key to reach the Calibration Factor window. The window appears similar to Figure 36 below. To step through each parameter, press the [▼] key.

The screenshot shows a window titled "Correction Factors" with two tabs: "Reynolds Correctio" and "Calibration Factor". The "Calibration Factor" tab is active. Inside the window, there are several controls:

- "Calibration Factor" with two radio buttons: "On" (selected) and "Off".
- "K Factor" with two radio buttons: "Single" (selected) and "Table".
- "Meter K-Factor" with a text input field containing the value "10".
- "Data Source" with an empty text input field.
- An "Edit Table" button below the "Data Source" field.

 At the bottom of the window are two buttons: "Cancel" and "OK".

Figure 36: The Calibration Factor Window

1. The first prompt asks if you wish to enable the calibration factor.
 - a. Use the [◀] and [▶] keys to scroll to the appropriate radio button.
 - b. Press [ENTER] to confirm your selection.
2. The next prompt asks if you want a single K factor or a table of K factors.
 - a. Use the [◀] and [▶] keys to scroll to the appropriate radio button.
 - b. Press [ENTER] to confirm your selection.

3.11.3 Entering a Calibration Factor (cont.)

3. The following steps depend on whether you select a single value or a table.

If you entered Single:

The prompt asks for a value. This feature enables a single multiplier to be applied to the flow rate reported by the PT878.

- a. Press [ENTER] to open the text box.
- b. Use the numeric keys to enter the desired value. Generally, if you have enabled the Reynolds Correction factor, the correction factor should be set to 1.00. Otherwise, the typical factor is between 0.5 and 2.00.
- c. Press [ENTER] to confirm your selection.

You have completed entering data for a single Calibration Factor.

- To confirm the entries and return to Operate mode, press [F3] (OK). The PT878 returns to Operate Mode.
- To leave the window without confirming the entries, press [F2] (Cancel) or the [ESC] key. The PT878 returns to Operate Mode.

3.11.3 Entering a Calibration Factor (cont.)

If you entered Table:

The menu asks, first for the data source, and then for the entry of values into the Correction Factor table. This feature allows the user to “curve fit” velocity calibration multiple data points (from several different data sources or flow variables) to the flow rate reported by the PT878.

- a. Press [ENTER] to open the Data Source window.
 - b. Press [F3] (OK) to confirm your selection. (Velocity is the only choice available.)
4. The prompt then asks if you wish to edit the K factor table.
- a. Press [ENTER] to open the table, which appears similar to Figure 37 below.

Edit KFactor Table		
		0
	Data Source	KFactor
1		
2		
3		
4		
5		
<input type="button" value="Cancel"/>		<input type="button" value="OK"/>

Figure 37: KFactor Table

3.11.3 Entering a Calibration Factor (cont.)

- b. Use the numeric keys to enter the desired value for the data source, and press [ENTER] to confirm the entry.
- c. Press the [▶] key to move to the KFactor column. Use the numeric keys to enter the desired value, and press [ENTER] to confirm the entry.
- d. Repeat steps b and c for the remainder of the table.
- e. When you have completed entering values, press [F3] (OK) to confirm the table and return to the Correction Factors window.

You have completed entering data for correction factors.

- To confirm the entries and return to Operate mode, press [F3] (OK). The PT878 returns to Operate Mode.
- To leave the window without confirming the entries, press [F2] (Cancel) or the [ESC] key. The PT878 returns to Operate Mode.

Chapter 4. Creating and Managing Sites

As mentioned in Chapter 1, the PT878 can store site data in files for current and future access. (To learn how to program setup data, refer to Chapter 3, *Programming Site Data*.) After you answer the necessary questions, simply save the information to a site file. The Site Manager option then enables you to recall, rename, revert to, transfer or delete site files as needed.

To open the Site Menu, press the [MENU] key at the lower right of the PT878 keypad. The Menu Bar replaces the Status Bar at the top of the screen. Then press [ENTER]. The screen now appears similar to Figure 38 below. While following the programming instructions, refer to Figure 137 on page 219 and Figure 138 on page 221 of Appendix A, *Menu Maps*.

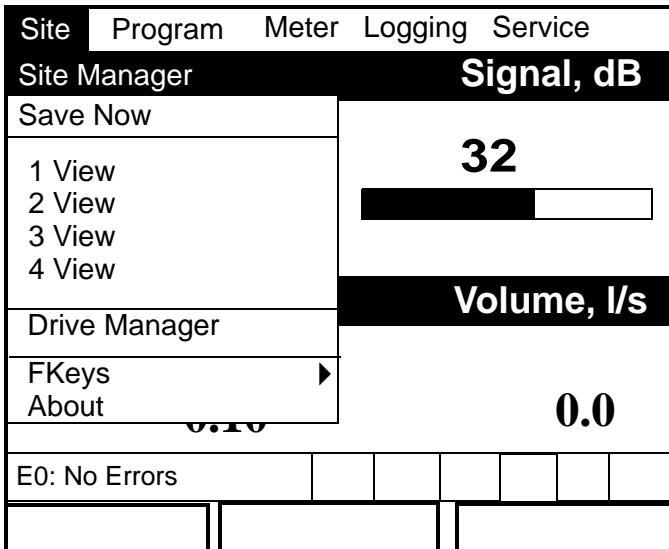

Figure 38: Site Menu

4.1 The Site Manager

From the Site Menu, press [ENTER] to open the Site Manager. The screen appears similar to Figure 39 below.

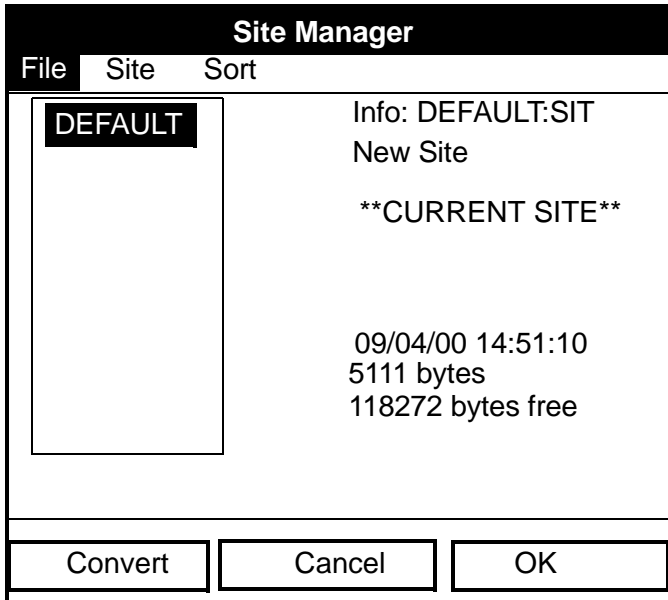

Figure 39: Site Manager Window

Note: *Each PT878 comes preprogrammed with a basic site, Default, which serves as a basis for saving data and creating other sites.*

The right section of the screen supplies information for the site highlighted in the list on the left: its date, time and size, as well as the remaining amount of free memory. You can use the [▼] and [▲] arrow keys to scroll to a particular site and display information pertaining to that site.

To open the Site Manager menu, press [MENU] and then [ENTER]. The screen now appears similar to Figure 40 on page 73.

4.1 The Site Manager (cont.)

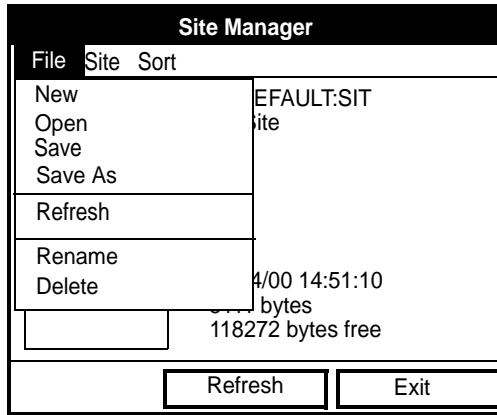

Figure 40: Site Manager Menu

Depending on the choice made above, proceed as follows:

- To create a new site, go to page 74.
- To open an existing site (thus replacing the current site), go to page 76.
- To save a current site, go to page 77.
- To refresh site information, go to page 79.
- To rename a site, go to page 78.
- To delete a site, go to page 80.

You can access five additional functions from the Site submenu (shown in Figure 48 on page 81).

- To add a site message, go to page 81.
- To transfer a site to a PC, go to page 83.
- To transfer a site in text format, go to page 83.
- To transfer a site from a PC to the PT878, go to page 85.

4.1 The Site Manager (cont.)

You can arrange files from the Sort submenu (shown in Figure 53 on page 86)

- To sort files by name, go to page 86.
- To sort files by date, go to page 87.

4.1.1 Creating a New Site

Note: *Be sure you have entered the necessary setup data discussed in Chapter 3, Programming Site Data, before creating and saving a new site.*

To create a new site within the Site Manager, press [MENU] to open the File Menu. Be sure the option New is highlighted, and then press [ENTER]. The screen appears similar to Figure 41 below.

New Site							
Site 01							
A	B	C	D	E	F	G	H
I	J	K	L	M	N	O	P
Q	R	S	T	U	V	W	X
Y	Z	0	1	2	3	4	5
6	7	8	9	-	_	@	#
&	()					
Delete		Cancel			OK		

Figure 41: Name Entry Window for a New Site

1. Use the four arrow keys to scroll to the desired letter or number, and press [ENTER].

4.1.1 Creating a New Site (cont.)

2. Repeat this procedure until you have created the desired site name of up to eight characters. (Press [F1], Delete, to remove any unwanted letters or numbers.)
3. When you have finished, press [F3] (OK) to confirm the entry, or [F2], Cancel, to leave the window without creating a site.

A second screen appears (as shown in Figure 42 below) asking if you want to use the currently highlighted site as a template, with the current display windows, measurements and programmed data. (To modify the display and measurements, refer to Chapter 5, *Displaying and Configuring Data*. To alter programming data, see Chapter 3, *Programming Site Data*.)

- Press [F2] (No) if you do not want to use it, or
- Press [F3] (Yes) if you do want to use it as a template.

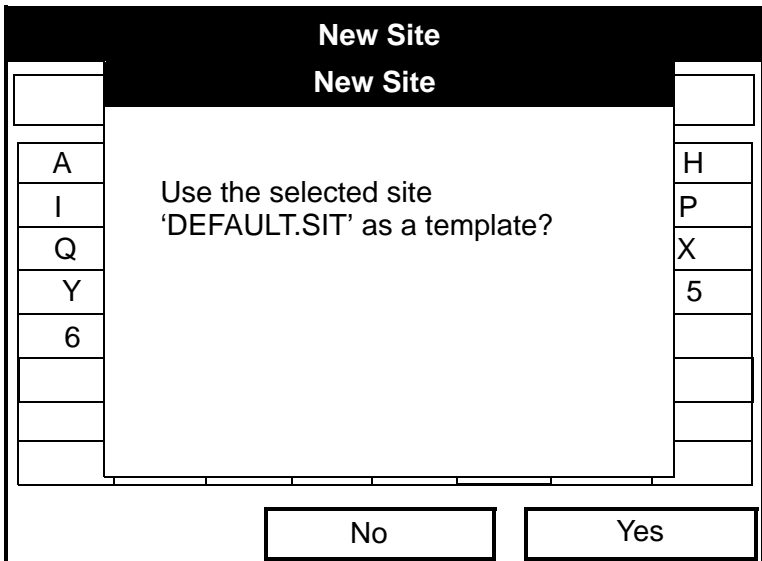

Figure 42: Template Confirmation Window

The meter returns to Operate Mode, with the new site name displayed in the upper left corner of the screen.

4.1.2 Opening an Existing Site

If you want to return to a site you have previously saved, first highlight the replacement site in the left window of the Site Manager. Then press [MENU] to open the File Menu. Scroll to the Open option, and press [ENTER]. The screen appears similar to Figure 43 below.

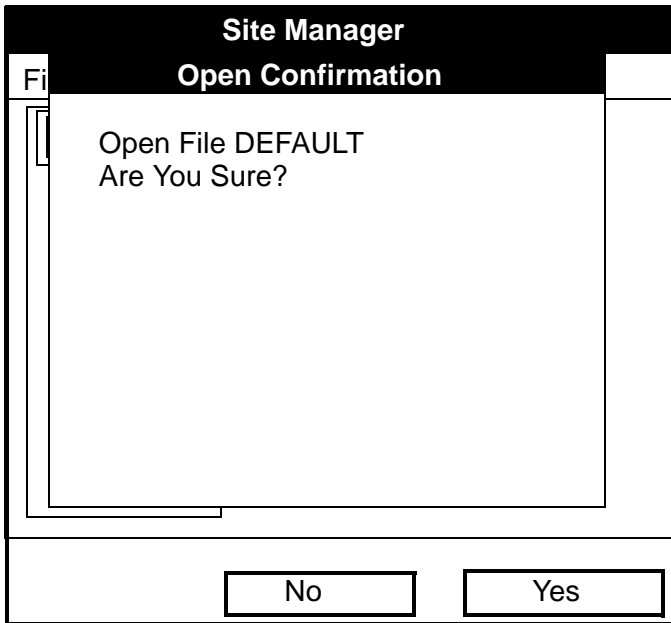

Figure 43: Open Site Confirmation Window

- Press [F2] (No) to cancel opening the site and return to the current site, or
- Press [F3] (Yes) to open the site.

If you have changed the current site, the PT878 asks if you want to save the changes to the previously opened site.

- Press [F2] (No) to cancel the changes, or
- Press [F3] (Yes) to confirm and save the changes.

The PT878 returns to Operate Mode, with the selected site displayed in the upper left corner of the screen.

4.1.3 Saving a Site

You can save the current site in one of two ways:

- From the Site Menu, you can scroll down to the Save Now option and press [ENTER], or
- From within the Site Manager, press [MENU] to open the File Menu, scroll to the Save option, and press [ENTER].

In either case, the screen appears similar to Figure 44 below.

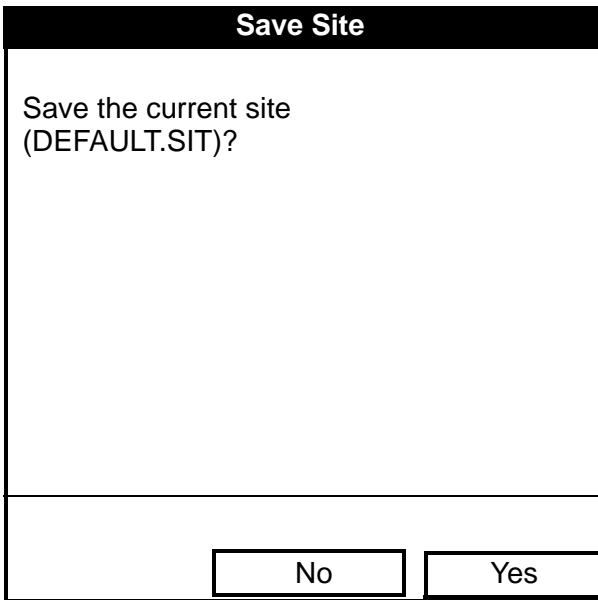

Figure 44: Save Current Site Window

- Press [F2] (No) to cancel saving the site, or
- Press [F3] (Yes) to save the site.

The PT878 remains in the current window (Operate Mode or Site Manager), with the current site saved.

4.1.4 Saving a Site with a Different Name

If you want to save the current site with a different name, open the Site Manager, press [MENU] to open the File Menu, scroll to the Save As option, and press [ENTER]. The screen appears similar to Figure 45 below.

Save Current Site							
A	B	C	D	E	F	G	H
I	J	K	L	M	N	O	P
Q	R	S	T	U	V	W	X
Y	Z	0	1	2	3	4	5
6	7	8	9				
Delete		Cancel			OK		

Figure 45: Save As (Another Name) Window

Use the four arrow keys to scroll to the desired letter or number, and press [ENTER]. Repeat this procedure until you have created the desired site name. (Press [F1], Delete, to remove any unwanted letters or numbers.) When you have finished,

- Press [F2] (Cancel) to erase the entry, or
- Press [F3] (OK) to confirm the entry.

The Save Site window then appears.

- Press [F2] (No) to cancel saving the site, or
- Press [F3] (Yes) to save the site.

The PT878 remains in Site Manager, with the current site saved under both the old and new names.

4.1.5 Refreshing a Site

You can refresh a site (updating the display with the most current information) in one of two ways:

- Press [F2], Refresh, to refresh the highlighted file.
- From the File Menu, scroll to the Refresh option and press [ENTER].

The updated information on the highlighted file appears in the window on the right. However, to save the file, you must use the Save option.

4.1.6 Renaming a Site

If you want to rename a site, first be sure the site has been highlighted in the left window of the Site Manager. Then press [MENU] to enter the File Menu, scroll to the Rename option, and press [ENTER]. The screen appears similar to Figure 46 below.

Rename Site							
DEFAULT							
A	B	C	D	E	F	G	H
I	J	K	L	M	N	O	P
Q	R	S	T	U	V	W	X
Y	Z	0	1	2	3	4	5
6	7	8	9				
Delete		Cancel			OK		

Figure 46: Rename Site Window

Use the four arrow keys to scroll to the desired letter or number, and press [ENTER]. Repeat this procedure until you have created the desired site name. (Press [F1], Delete, to remove any unwanted letters or numbers.) When you have finished,

- Press [F2] (Cancel) to erase the entry, or
- Press [F3] (OK) to confirm the entry.

PT878 remains in Site Manager, with the site listed under the new name.

4.1.7 Deleting a Site

To delete a site in the Site Manager, first be sure you have highlighted that site in the left window of the Site Manager. Then press [MENU] to open the File Menu, scroll to the Delete option, and press [ENTER]. The screen appears similar to Figure 47 below.

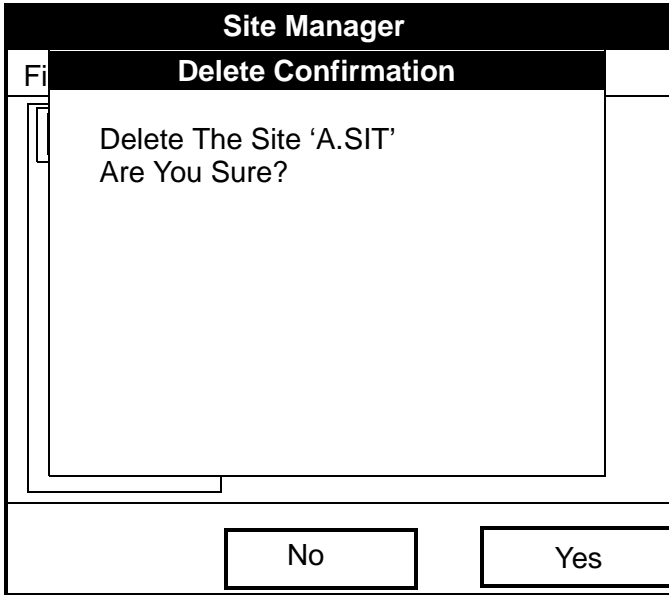

Figure 47: Delete Confirmation Window

- Press [F2], No, to cancel the deletion and return to the Site Manager, or
- Press [F3], Yes, to delete the site.

The Site Manager appears, with the highlighted site now deleted.

4.1.8 Creating a Site Message

The Site Message option allows you to add an explanatory message (with up to 30 characters or spaces) for any given site. To create a site message:

1. Press [MENU] to enter the File Menu. Then press the [▶] arrow key once to scroll from the File Menu to the Site Menu. Press [ENTER]. The screen appears similar to Figure 48 below.

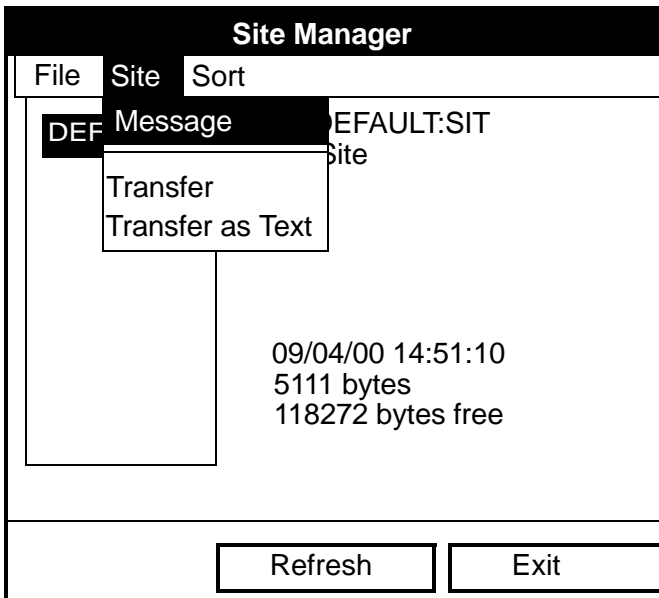

Figure 48: Site Menu in the Site Manager

2. Press [ENTER] to select “Message,” which opens the text creation window, shown in Figure 49 on page 82.

4.1.8 Creating a Site Message (cont.)

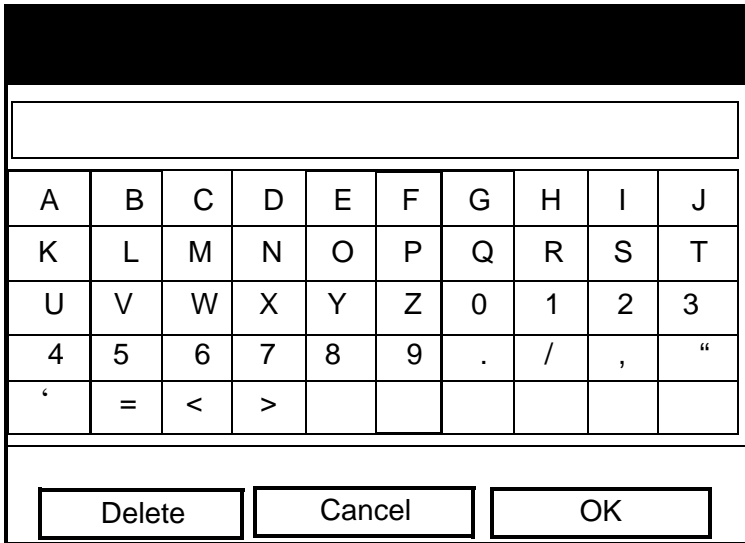

Figure 49: Text Creation Window

- Use the four arrow keys to scroll to the desired letter or symbol, and press [ENTER] to add the letter to the message.

Note: *Pressing [SEL] causes the screen to alternate between a set of upper-case (capital) letters, a set of lower-case letters, and a set of symbols. Use all three screens to create a desired message.*

- Repeat this procedure for each letter or symbol you wish to add to the message. If you wish to delete a letter, press [F1] (Delete) to erase each letter or symbol, from right to left on the label.

When you have completed the message, press [F3] (OK) to confirm the message, or [F2] (Cancel) to leave the window without adding the message.

4.1.9 Transfer Files Between the PT878 and a PC

4.1.9a Site Files

Site files contain configuration parameters for the PT878. These parameters can be changed one at a time and saved in the meter's memory via either PanaView or the PT878 keypad. Site files can be transferred as text to the PC and transferred as files between the PC and the PT878 meter.

4.1.9b Transfer a Site File as Text using HyperTerminal

To transfer a PT878 site file to a PC as text using HyperTerminal, complete the following steps:

1. Connect the PT878 USB port to any USB port on the PC (page 9).
2. Start HyperTerminal and set up the communication link to match the PT878 Com port settings.
3. From the PT878 select Site\Site manager and select the site file you want to print to PC.
4. From Site manager select Site\Transfer as Text. This should print out the site file as text to HyperTerminal.

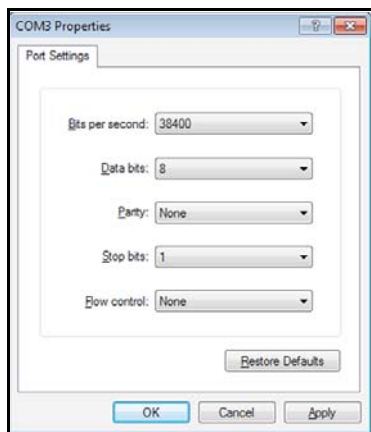

Figure 50: COM Properties

4.1.9b Transfer a Site File as Text using HyperTerminal

To save the site file as text in HyperTerminal, complete the following steps:

1. Select the *Transfer\Capture Text* option.
2. Select the location of the file and the filename. Then, click *Start*.
3. Transfer the site file as text from the PT878 and then select the *Transfer\Capture Text\End* option in HyperTerminal. The site file transfer is now complete.

4.1.9c Transfer a Site File as a File from the PT878 to a PC

To transfer a PT878 site file to a PC as a file, complete the following steps:

1. Connect the PT878 USB port to any USB port on the PC (page 9).
2. Start HyperTerminal and set up the communication link to match the PT878 Com port settings.
3. From the PT878 select *Site\Site Manager* and then select the site file you want to transfer to the PC.

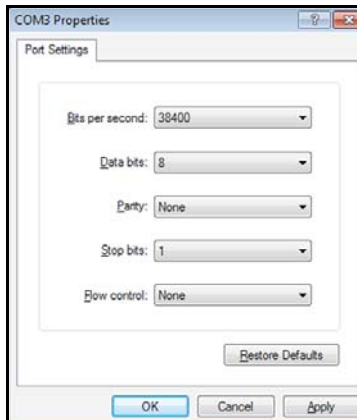

Figure 51: COM Properties

4.1.9c Transfer a Site File as a File from the PT878 to a PC (cont.)

To save the site file as a file using HyperTerminal, complete the following steps:

1. Select the *Transfer\Receive File* option.
2. Select the location of the file and the XModem receiving protocol.
3. Click the *Receive* option and enter the Filename.
4. From *PT878 Site Manager*, select the *Site\Transfer* option. This will allow the PT878 to send the site file to a PC using the secure XModem protocol. File transfer is complete when the XModem Receive dialog box closes.

4.1.9d Transfer a Site File as a File from a PC to the PT878

To transfer a site file from a PC to the PT878 as a file, complete the following steps:

1. Connect the PT878 USB port to any USB port on the PC (page 9).
2. Start HyperTerminal and set up the communication link to match the PT878 Com port settings.
3. From the PT878 select *Site\Site Manager* and then select *Site\Transfer* from the PC. Type in the name of the site file and click OK.

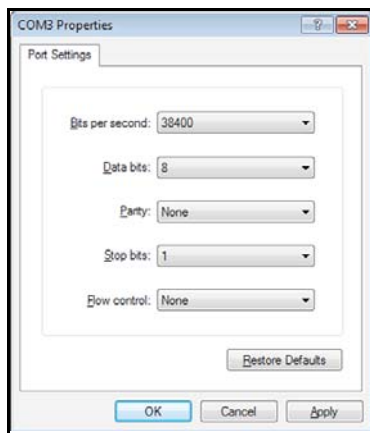

Figure 52: COM Properties

4.1.9d Transfer a Site File as a File from a PC to the PT878 (cont.)

From HyperTerminal, complete the following steps:

1. Select the *Transfer\Send File* option.
2. Select the location of the file and the XModem protocol.
3. Click *Send*. File transfer is complete when the XModem Receive dialog box closes. The file should now appear in the PT878 Site Manager.

4.1.10 Listing Files by Name

If you want to list your files alphabetically by site name within the Site Manager, press [MENU] to open the File Menu. Then press the [▶] arrow key twice to scroll from the File Menu to the Sort Menu, shown in Figure 53 below. Press [ENTER]. The Site Manager screen refreshes, with the sites listed in alphabetical order.

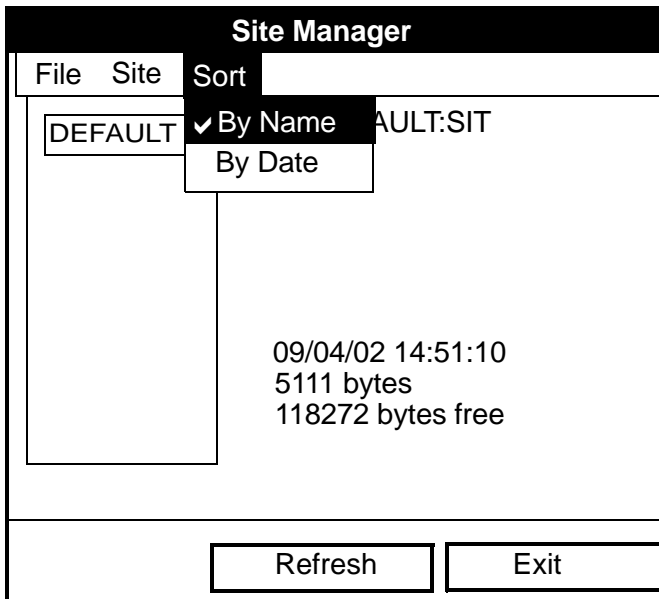

Figure 53: Sort Submenu

4.1.11 Listing Files in Chronological Order

If you prefer to list your files chronologically by time of creation within the Site Manager, press [MENU] to open the File Menu. Then press the [▶] arrow key twice to scroll from the File Menu to the Sort Menu, and scroll to the By Date option. Press [ENTER]. The Site Manager screen refreshes, with the sites listed in chronological order, from the most recent to the earliest.

[no content intended for this page - proceed to next page]

Chapter 5. Displaying and Configuring Data

The PT878 allows you to view from one to four different measurement parameters simultaneously. The screen can show these parameters not only in numeric format, but as line or bar graphs as well.

You can configure any given measurement for your particular requirements. To configure an individual measurement, press [SEL] from the Operate Mode window shown in Figure 6 on page 16. A cursor appears next to the parameter closest to the upper left corner. Continuing to press [SEL] enables the cursor to scroll through the other displayed measurements. Once you have reached a particular window, pressing the [ENTER] button opens the menu for that window, as shown in Figure 54 below. To learn how to use the display window menu, see page 90 to page 94.

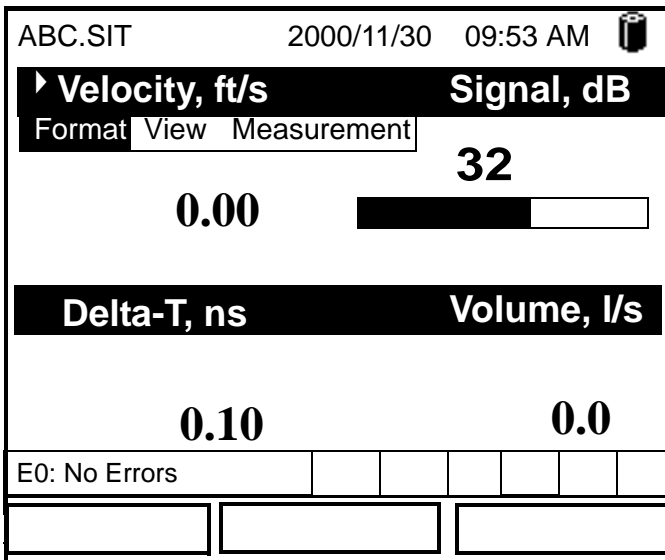
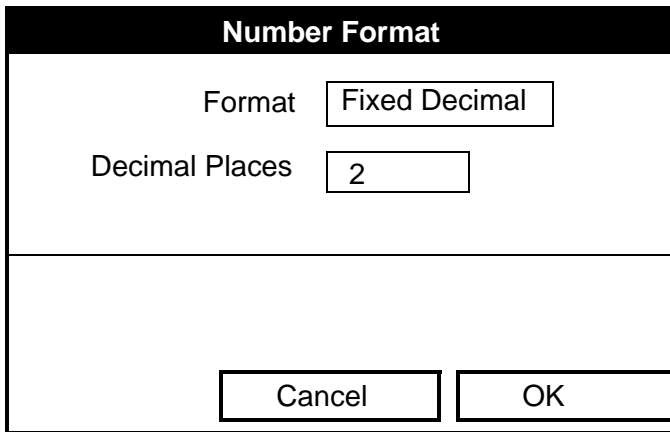

Figure 54: Display Screen After Pressing [SEL]

5.1 The Format Option

The first option on the menu, Format, allows you to specify the type of notation and the number of decimal places for the measurement in that window. Press [ENTER] and the submenu shows two options, Decimal Place and Notation. Press the [▼] or [▲] arrow keys to select either entry, and press [ENTER]. The screen appears similar to Figure 55 below. To scroll to a particular parameter or menu entry, press the [▼] or [▲] key.

Note: *If the window displays a line or bar graph, the Limits option appears instead of Format in the menu.*



The screenshot shows a window titled "Number Format". Inside the window, there are two input fields. The first is labeled "Format" and contains the text "Fixed Decimal". The second is labeled "Decimal Places" and contains the number "2". At the bottom of the window, there are two buttons: "Cancel" and "OK".

Figure 55: Number Format Window

1. The first entry, Format, asks you to select the numeric format from three choices: default, fixed decimal and scientific. Default provides the default resolution, while Fixed Decimal allows users to override the standard resolution. Scientific format displays the value in mantissa and exponent format.
 - a. Press [ENTER] to open the drop-down list of format choices.
 - b. Scroll to the appropriate selection.
 - c. Press [ENTER] to confirm your choice.

5.1 The Format Option (cont.)

2. The second step asks you to choose the number of decimal places to be displayed. Available choices range from 0 to 4 places.
 - a. Press [ENTER] to open the drop-down list.
 - b. Scroll to the appropriate number.
 - c. Press [ENTER] to confirm your choice.
- To confirm the entries and return to Operate mode, press [F3] (OK).
- To leave the window without confirming the entries, press [F2] (Cancel) or the [ESC] key.

5.2 The View Option

The second option, View, allows you to select the presentation of a parameter in one of three formats: numeric, line graph or bar graph.

1. From the Display Menu, press the [▶] key once to reach the View option, and then press [ENTER].
2. A drop-down menu shows the three formats. Scroll to the appropriate selection.
3. Press [ENTER] to confirm your selection.

The screen immediately displays any changes. For example, if you have changed the first parameter to a line graph, the screen appears similar to Figure 56 below.

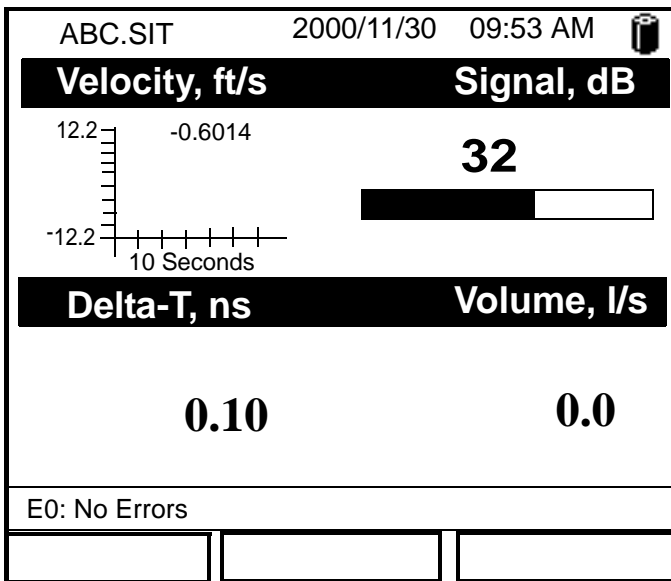

Figure 56: Screen After Format Change

5.3 The Limits Option

Once you have configured a parameter as a line or bar graph, you might need to change its presentation or values. The Limits option (replacing the Format option for line and bar graphs) enables you to program the minimum or maximum values displayed, the time interval and the display of the average value.

To enter the Limits option:

1. Press [SEL] from the Operate Mode window until you have reached the desired measurement.
2. Press [ENTER] to open the Display Menu.
3. Be sure the Limits option is highlighted, and press [ENTER].
4. A drop-down menu entry, Change, appears. Press [ENTER] again.

The screen appears similar to Figure 57 below.

Set Line Graph Parameters

Velocity

Minimum

Maximum

Use Lines

Plot Average Value

Show Minimum and Maximum

Figure 57: Line (or Bar) Graph Parameters Window

5.3 The Limits Option (cont.)

5. The first prompt asks for the minimum value shown in the graph.
 - a. Press [ENTER] to open the text box.
 - b. Use the numeric keys to enter the desired value.
 - c. Press [ENTER] to confirm the value.
6. Repeat the procedure in step 5 to enter the maximum value.

A line graph involves two more prompts.

7. The next prompt asks for the display interval.
 - a. Press [ENTER] to open the text box. Use the numeric keys to enter the desired number. Press [ENTER] to confirm the value.
 - b. The second box asks for the interval in terms of seconds, minutes, hours, or days. Press [ENTER] to open the drop-down menu, and then press the [▼] or [▲] keys to move to the desired parameter. Press [ENTER] to confirm the entry.
8. The final three prompts ask for details of the graph configuration: if you want to use lines, plot the average value, or show the minimum and maximum values. Press the [▼] key to step through each value, and press [ENTER] to add a given detail as part of the graph.
9. When you have configured the graph, press [F3] (OK) to confirm the graph settings.

The screen returns to Operate Mode, and displays any changes.

5.4 The Measurement Option

On occasion, you might need to change the actual parameter measured in a given window. The Measurement option enables you to reconfigure the window with one of five categories of data source (velocity, volume, forward or reverse totalizer, power, energy or diagnostics) and appropriate English or metric measurement units.

To enter the Measurement option:

1. Press [SEL] from the Operate Mode window until you have reached the desired measurement.
2. Press [ENTER] to open the Display Menu.
3. Be sure the Measurement option is highlighted, and press [ENTER].
4. A drop-down menu entry, Change, appears. Press [ENTER] again.

The screen appears similar to Figure 58 on page 96. The left column displays the five measurement data sources, while the right column displays English and metric measurement units (or, with the Diagnostics source shown, a list of diagnostics parameters).

5. Use the [▼] and [▲] arrow keys to reach the desired data source, and press [SEL].
6. Then use the [▼] or [▲] arrow keys to select the desired measurement unit (or diagnostic parameter). Press [F3] (OK) to confirm the entry.
7. The screen returns to Operate Mode, and displays any changes.

5.4 The Measurement Option (cont.)

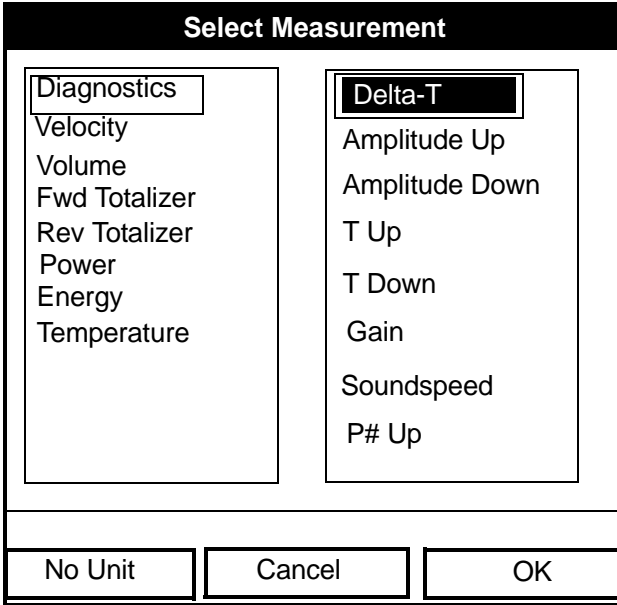

Figure 58: Measurement Menu Window

5.5 Customizing the Display Screen

You might wish to display one or two parameters, or customize the soft keys to quickly access particular menus. The Site Menu enables you to make more comprehensive changes in your display screen.

To enter the Site Menu, press the [MENU] key at the lower right of the PT878 keypad. The Menu Bar replaces the Status Bar at the top of the screen. The Site Menu will be highlighted in the upper left corner. Press [ENTER] or the [▼] arrow key. The screen now appears similar to Figure 59 below. While following the programming instructions, refer to Figure 138 on page 221 of Appendix A, *Menu Maps*.

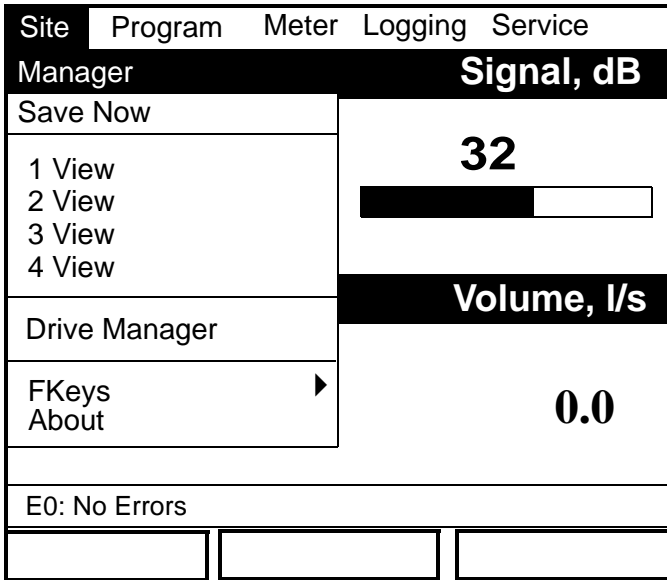

Figure 59: Site Menu

- To specify the number of parameters displayed, go to page 98.
- To customize or clear softkeys (FKeys), go to page 99.

5.5.1 Specifying the Number of Displayed Parameters

As mentioned earlier, the PT878 can display one to four different measurement parameters simultaneously. However, sometimes you might wish to display only one or two parameters. To change the number of open display windows from within the Site Menu (shown in Figure 59 on page 97), use the [▼] or [▲] arrow keys to move to the desired number of views (1 View, 2 Views, etc.) Press [ENTER].

The screen displays the designated number of windows. For example, Figure 60 below shows the screen displayed in Figure 56 on page 92, reconfigured for a single view.

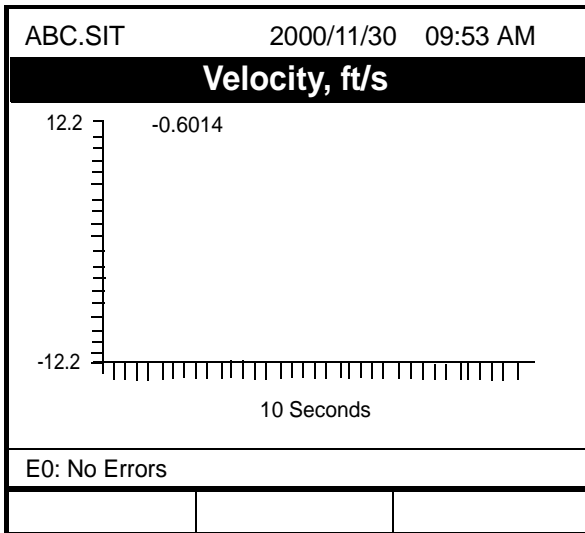

Figure 60: Display Screen Configured for Single View

Note: *The PT878 opens display windows clockwise from the upper left; that is, if you press “1 View,” the parameter displayed in the upper left window appears. If you press “2 Views,” the parameters shown in the two top windows appear. The view for “3 Views” adds the window in the lower left, and that for “4 Views” adds the window in the lower right.*

5.5.2 Customizing Softkeys

When the screen is in Operate Mode, you might wish to access a particular submenu frequently without the trouble of scrolling through menus.

Customizing the softkeys ([F1], [F2] and [F3]) allows you to access up to three submenus by pressing the associated softkey. You can customize a softkey from the Site Menu or from within a particular menu.

- To customize a softkey from within the Site Menu:
 - From the Site Menu (shown in Figure 59 on page 97), use the [▼] or [▲] arrow keys to move to the FKeys entry on the menu. Press [ENTER]. The screen now appears similar to Figure 61 below.

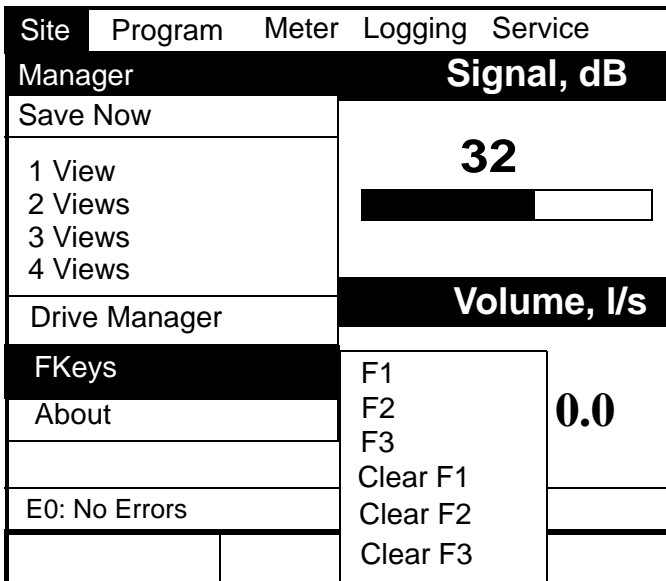

Figure 61: FKeys Menu

- Use the [▼] or [▲] arrow keys to move to the desired FKey (1, 2 or 3) entry on the menu. Press [ENTER]. The Configure FKey window opens, as shown in Figure 62 on page 100.

5.5.2 Customizing Softkeys (cont.)

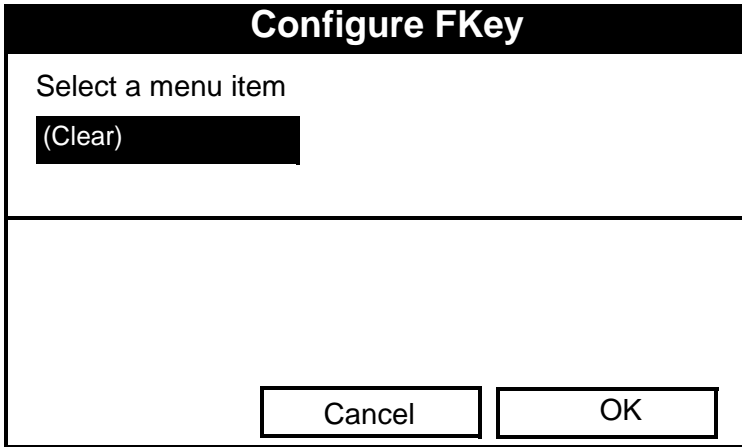

Figure 62: Configure FKey Window

3. Press [ENTER] to open the menu drop-down list. Then use the [▼] or [▲] arrow keys to scroll to the desired submenu (for example, Contrast).
4. Press [ENTER] to confirm the entry, and press [F3] (OK) to confirm the entry and close the window. (Press [F2] (Cancel) to close the window without changing the key.)

The screen now appears similar to Figure 63 on page 101, with the [F1] window displaying “Contrast.” Pressing [F1] opens the Contrast window.

- To customize a softkey from a particular menu:
 1. Open the desired menu on the Menu Bar (see Chapters 3, 4, 6, 7 and 8 for details on particular menus) and scroll to the desired option.
 2. Press the desired softkey. A window appears with the question, “Assign current menu command to FKeyX?”
 3. Press [F3] (Yes) to confirm the assignment and close the window. (Press [F2] (No) to close the window without changing the key.)

5.5.2 Customizing Softkeys (cont.)

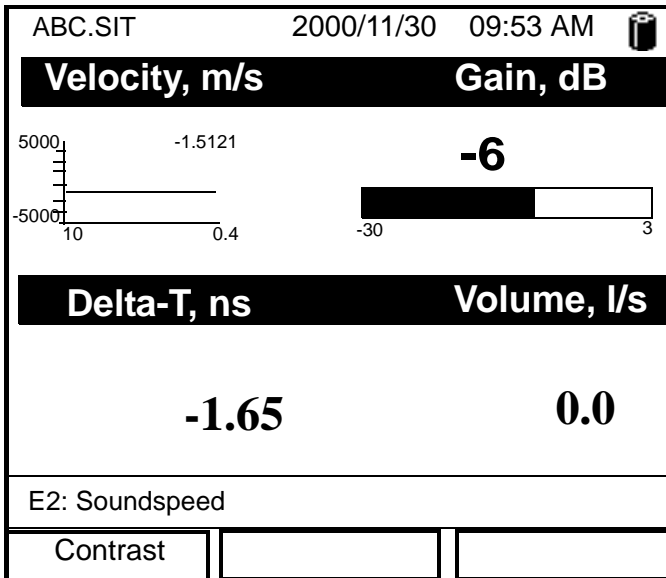

Figure 63: Display Screen with Modified Softkey

- To clear a softkey:
 - From the Site Menu (shown in Figure 59 on page 97), use the [▼] or [▲] arrow keys to move to the FKeys entry on the menu. Press [ENTER]. The screen now appears similar to Figure 61 on page 99.
 - Use the [▼] or [▲] arrow keys to move to the desired Clear FKey (1, 2 or 3) entry on the menu. Press [ENTER].

The softkey window clears. You can also clear the softkey through the Configure FKey window, by selecting (Clear) as an entry, pressing [ENTER] and then [F3] (OK).

Note: *Since the customized softkeys are saved globally, they will remain, even if you change site files.*

5.6 Managing Files – The Drive Manager

On occasion, you might want to review or transfer some or all of the files in the PT878. The Drive Manager allows you to view all the files stored in the meter. While following the programming instructions, refer to Figure 138 on page 221 of Appendix A, *Menu Maps*. To open the Drive Manager:

1. Press [MENU].
2. From the Site Menu (shown in Figure 59 on page 97), use the [▼] or [▲] arrow keys to move to the Drive Manager entry on the menu. Press [ENTER]. The screen now appears similar to Figure 64 below.

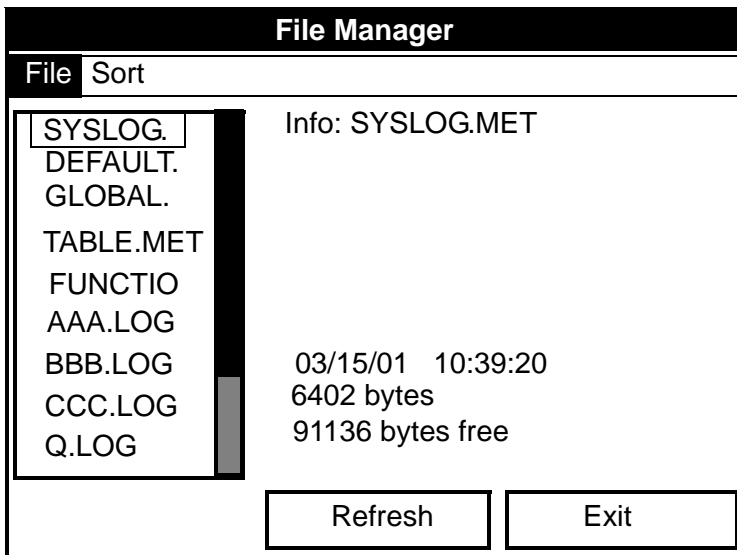

Figure 64: Drive Manager Window

The window on the left lists all the meter, site and log files in the PT878, while the window on the right displays information on the file highlighted in the left window.

5.6 Managing Files — The Drive Manager (cont.)

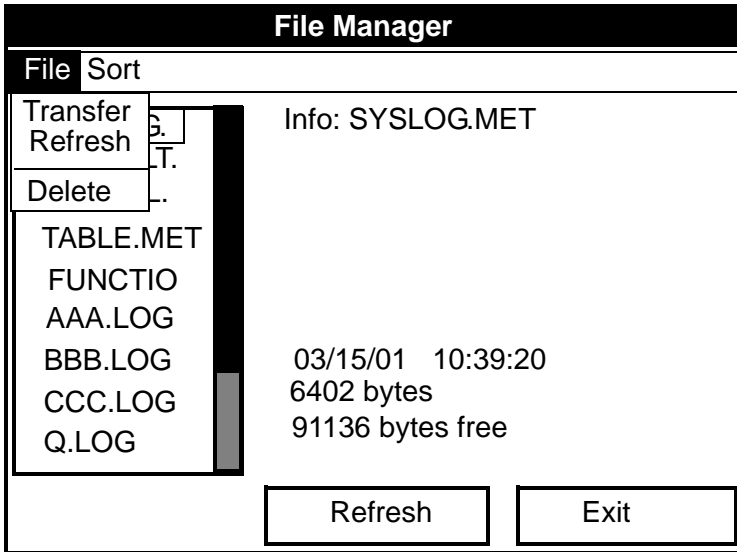

Figure 65: File Manager Menu

To transfer, refresh or delete a file, first be sure the file is highlighted in the window on the left. Then press [MENU] to open the File Menu, and scroll to the appropriate option, as shown in Figure 65 above. Press [ENTER]. The PT878 then performs the desired action with the file.

5.6.1 Transferring a File to a PC

To upload a log, meter, bitmap or site file to a PC:

1. Connect the PT878 USB port to any USB port on the PC (page 9).
2. Start HyperTerminal and set up the communication link to match the PT878 Com port settings.
3. From the PT878 select *Site\Site Manager* and then select the file you want to transfer to the PC.
4. Select the *Transfer\Receive File* option.
5. Select the location of the file and the XModem receiving protocol.
6. Click the *Receive* option and enter the Filename.
7. From PT878 *Site Manager*, select the *Site\Transfer* option. This will allow the PT878 to send the site file to a PC using the secure XModem protocol. File transfer is complete when the XModem Receive dialog box closes.

5.6.2 Transferring a File from a PC to the PT878

Once you have stored site or meter files to a PC, you can then transfer them back to the PT878 over the USB interface. The PT878 only accepts files with a .sit (site) or .met (meter) extension. If you try renaming another type of file with a .sit or .met extension and transfer it, it will be transferred, but it will not function if you open it. Also, if you are transferring a file and the meter already has a file with the identical name, the meter will overwrite its current file with the transferred file. If the transferred file has a name longer than eight characters, the meter will shorten the name to eight characters, and replace any spaces in the name with underbars.

Note: *It is not possible to download log files back to the PT878.*

To download a site or meter file from a PC to a PT878:

1. Connect the PT878 USB port to any USB port on the PC (page 9).
2. Start HyperTerminal and set up the communication link to match the PT878 Com port settings.
3. From the PT878 select Site\Site Manager and then select Site\Transfer from the PC. Type in the name of the site file and click OK.

From HyperTerminal, complete the following steps:

1. Select the *Transfer\Send File* option.
2. Select the location of the file and the XModem protocol.
3. Click *Send*. File transfer is complete when the XModem Receive dialog box closes. The file should now appear in the PT878 Site Manager.

5.6.3 Refreshing a File

To refresh a file so that the PT878 displays the most recent information, you have two options:

- Press [MENU], scroll to the Refresh option, and press [ENTER].
- Press [F2] (Refresh).

In either case, the window on the right of the File Manager displays the most recent file information.

5.6.4 Deleting a File

To delete a file in the File Manager, first be sure you have highlighted that file in the left window of the File Manager. Then press [MENU], scroll to the Delete option, and press [ENTER]. The screen appears similar to Figure 66 below.

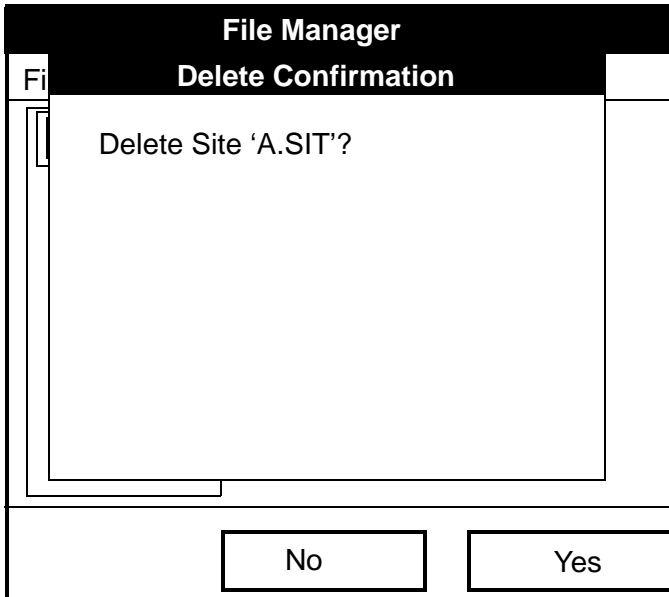

Figure 66: Delete Confirmation Window

- Press [F2], No, to cancel the deletion and return to the File Manager, or
- Press [F3], Yes, to delete the site.

The File Manager appears, with the highlighted site now deleted.

5.6.5 Listing Files by Name

If you want to list your files alphabetically by site name within the File Manager, press [MENU] to open the File Menu. Then press the [▶] arrow key to scroll from the File Menu to the Sort Menu, shown in Figure 67 below. Press [ENTER]. The File Manager screen refreshes, with the sites listed in alphabetical order.

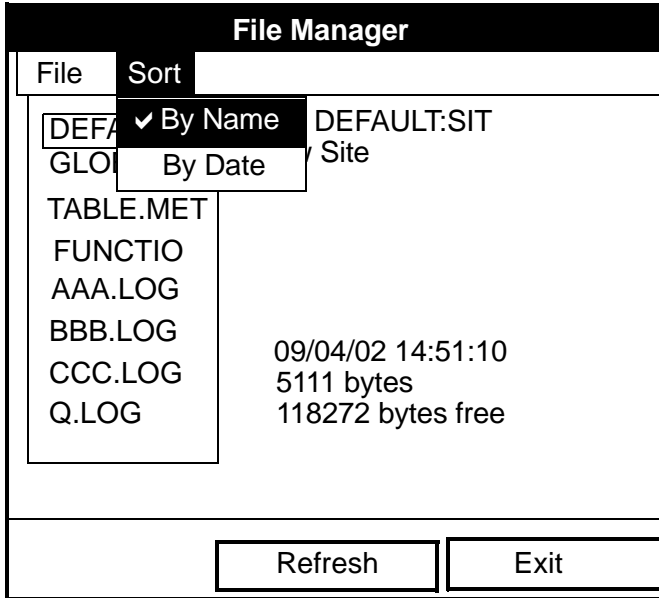

Figure 67: Sort Submenu

5.6.6 Listing Files in Chronological Order

If you prefer to list your files chronologically by time of creation within the File Manager, press [MENU] to open the File Menu. Then press the [▶] arrow key to scroll from the File Menu to the Sort Menu, and scroll to the By Date option. Press [ENTER]. The Site Manager screen refreshes, with the sites listed in chronological order, from the most recent to the earliest.

5.7 Accessing Meter Data —The About Option

The About option displays useful information concerning the model number and software version of any given PT878. While the window normally appears briefly at startup, users might want to access the information for a longer period. To open the About window, scroll to the About option on the Site Menu and press [ENTER]. The screen appears similar to Figure 68 below. To access data on your specific PT878, press [F2] (Next).

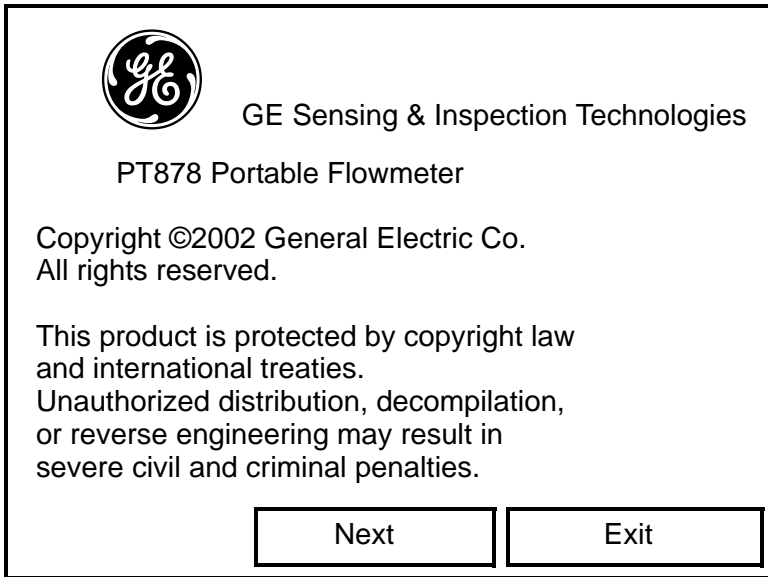

Figure 68: About Window

To return to Operate Mode, press [ESC] or [F3] (Exit).

[no content intended for this page - proceed to next page]

Chapter 6. Programming Meter Settings

Along with display formats and site data, PT878 users can program global settings for the meter that suit their individual preferences. The global settings include:

- English or Metric measurement units
- Battery power
- Date and time parameters and appearance (locale)
- Screen contrast
- Backlight timeout
- Language settings
- USB communications settings
- Resetting forward and reverse totals
- User tables
- Taking a bitmap capture of a screen

6.1 Entering the Meter Menu

To enter the Meter Menu, press the [MENU] key at the lower right of the PT878 keypad. The Main Menu replaces the Status Bar at the top of the screen. Press the [▶] arrow key twice to scroll from the Site Menu to the Meter Menu. At the Meter Menu, press [ENTER]. The screen appears similar to Figure 76 below. While programming, refer to Figure 140 on page 223 of Appendix A, *Menu Maps*.

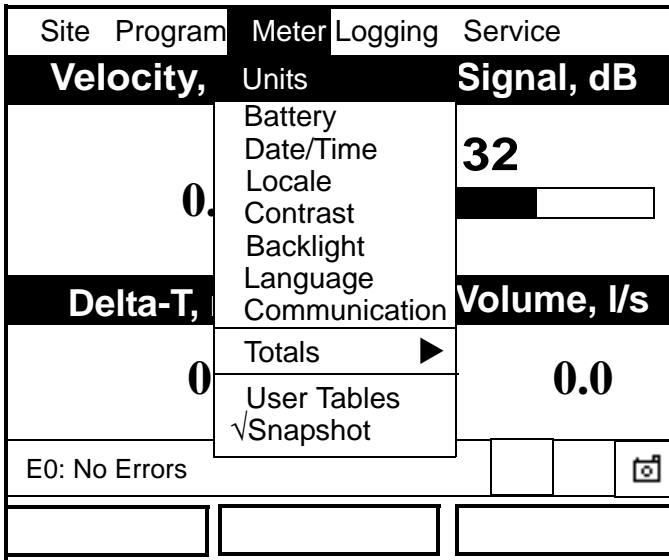

Figure 76: Meter Menu

To scroll to a particular option, press the [▼] or [▲] arrow keys until you reach the option. Then press [ENTER] to open the option window.

When entering parameters in an option, press:

- The [▼] key to step through the available parameters
- The [▲] key to scroll back to a previously entered parameter
- The [F2] key (Cancel) or the [ESC] key to exit an option at any time and return to Operate Mode without changing the parameters.

6.2 Selecting Measurement Units

The first option, Units, enables you to select either English or Metric units as global measurement units for the PT878. The selected units then become the default settings for every measurement that has the option for metric/English units. To select the units, scroll to the Units entry on the Meter menu and press [ENTER]. The Meter Settings window opens, as shown in Figure 77 below.

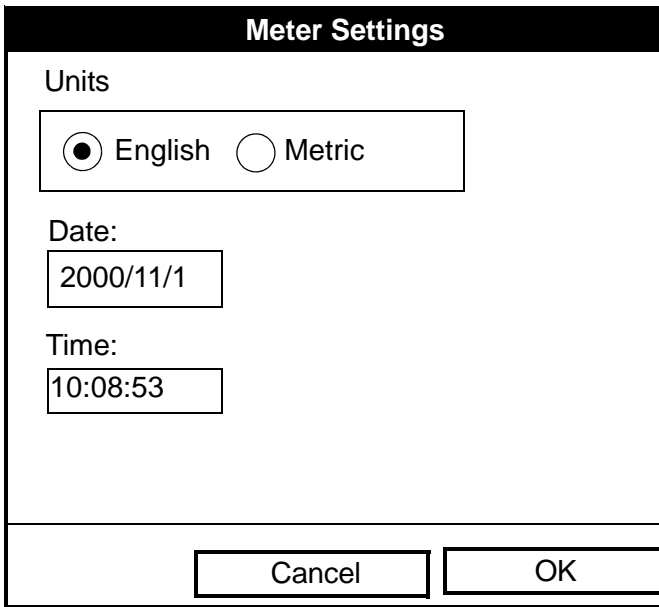

The screenshot shows a window titled "Meter Settings". Inside the window, there is a section labeled "Units" with two radio button options: "English" (which is selected) and "Metric". Below this, there are two input fields: "Date:" with the value "2000/11/1" and "Time:" with the value "10:08:53". At the bottom of the window, there are two buttons: "Cancel" and "OK".

Figure 77: Meter Settings Window

1. Use the [◀] and [▶] keys to scroll between English and Metric units.
2. Press [ENTER] to confirm the choice.

6.3 The Battery Charger

The Battery option allows you to monitor the current run time and status of the internal rechargeable batteries, as well as to condition NiCad batteries to maintain the maximum life possible. Conditioning NiCad batteries (a process that can take up to 12 hours for a fully charged pack) discharges the pack completely and then performs a fast charge.

Note: *When conditioning the batteries, be sure you have plugged the AC adapter into the PT878 and pressed the power key. NiMH batteries normally do not require conditioning.*

To open the option window:

1. From the Meter menu, scroll to the Battery entry and press [ENTER]. The Battery Charger window opens, as shown in Figure 78 below.
2. If you wish to open the Part Number window, press [ENTER]. You can choose from a 1.8 Ahr NiCad battery (part number 200-058) or a 3.0 Ahr NiMH battery (part number 200-081). Scroll to the battery type you have installed and press [ENTER].

Note: *If you do not set the correct battery type in the Part Number window, the battery continues to function, but the battery status icons (see page 13) will not be accurate.*

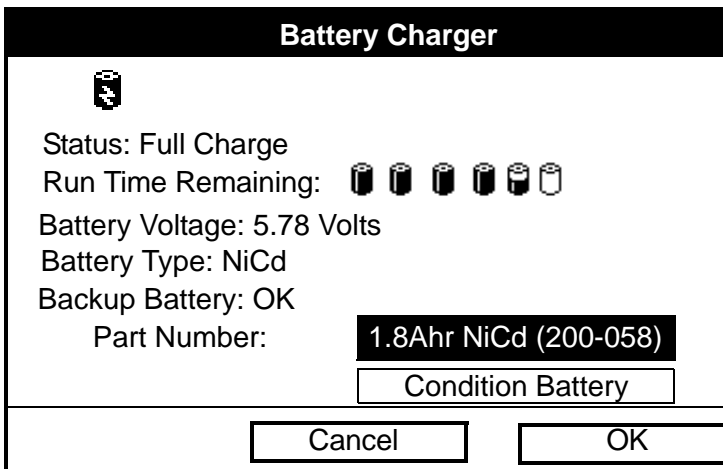

Figure 78: Battery Charger Window

6.3 The Battery Charger (cont.)

3. To condition the batteries, press the [ENTER] key. The “Condition Battery” window should now read “Stop.” The status line should change to “Discharging.” (Updating the status could take up to 30 seconds.)

Note: *It is advisable to condition NiCad batteries when their run time is reduced to 50% of their previous run time.*

4. To stop the discharge cycle, press the [ENTER] key and the “Condition Battery” window reappears. The status now changes to “On Charger.”
5. Press [F3] (OK) to return to Operate Mode.

6.4 Entering Date and Time

In Operate mode, the Status Bar displays the current date and time above the measurements in the upper right corner of the screen. The Date/Time option allows you to set the date or time, which are required for correct data logging operation.

To set the time:

1. From the Meter menu, scroll to the Date/Time entry and press [ENTER]. The Meter Settings window reopens, as shown in Figure 77 on page 113.
2. From the Units option, press the [▼] key once to reach the date text box. This box displays the current meter date.
3. Press [ENTER] to enter the text window. The meter highlights the center number. Use the [◀] and [▶] keys to scroll to any number you wish to change.

6.4 Entering Date and Time (cont.)

4. Two alternatives are available to change a highlighted number:
 - Use the numeric keys to enter the desired number.
 - Use the [▼] or [▲] arrow keys to scroll, in 1-digit increments, to the desired number. (For example, if the text box highlights 09, pressing the [▼] key twice changes the number to 07. You can scroll from 01 to 12 for the month and from 01 to 31 for the day (depending on the number you have selected for the month.)

In either case, press [ENTER] to confirm the entry.

To enter or change the time:

1. From the time text box, press the [▼] key once to scroll to the time text box. This box displays the current meter time.
2. Press [ENTER] to enter the text box. The meter highlights the first number. Use the [◀] and [▶] keys to scroll to any number you wish to change.
3. Two alternatives are available to change a highlighted number:
 - Use the numeric keys to enter the desired number.
 - Use the [▼] or [▲] arrow keys to scroll, in 1-digit increments, to the desired number. (For example, if the text box highlights 09, pressing the [▼] key twice changes the number to 07.) You can scroll from 01 to 12 for the hour and from 01 to 59 for the minute and second inputs.
4. In either case, press [ENTER] to confirm the entry.

Pressing the [▼] or [▲] arrow keys causes the meter to scroll within the Meter Settings options.

- To confirm the entries and return to Operate mode, press [F3] (OK). The PT878 returns to Operate Mode.
- To leave the window without confirming the entries, press [F2] (Cancel) or the [ESC] key. The PT878 returns to Operate Mode.

6.5 Changing Date and Time Appearance

In addition to setting the correct date and time, you can also change its presentation to suit local preferences. You can select a time display of AM/PM or 24-hour time.

To alter the time and date display:

1. From the Meter menu, scroll to the Locale entry and press [ENTER]. The Display Options window opens on the Format tab, as shown in Figure 79 below. To step through each parameter, press the [▼] key.

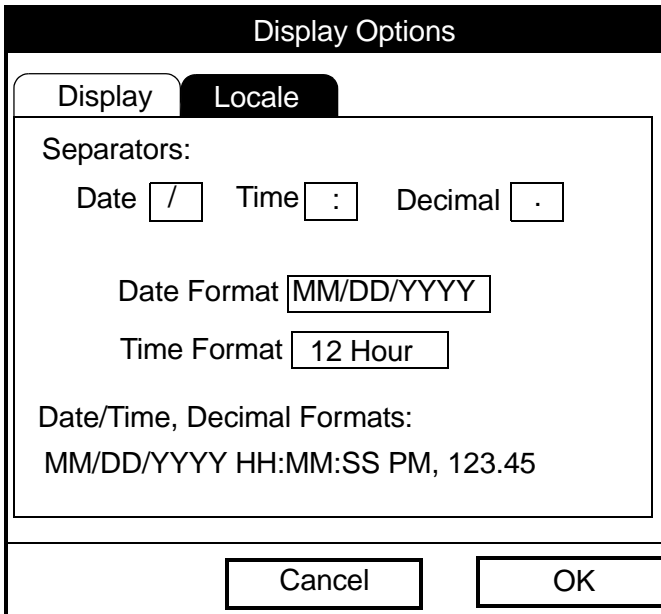

Figure 79: Format Tab in the Display Options Window

6.5 Changing Date and Time Appearance (cont.)

2. The first series of prompts asks you to select separator symbols for the date, time and decimal. You can choose from a dash, comma and slash (/) for the date; from a period and colon for the time; and from a period or comma for the decimal place. For each symbol type:
 - a. Press [ENTER] to open the drop-down menu.
 - b. Use the [▼] or [▲] arrow keys to scroll to the desired format.
 - c. Press [ENTER] to confirm your entry.
3. The next prompt asks you to select the date format.
 - a. Press [ENTER] to open the drop-down menu. Three options are available:
 - YYYY/MM/DD (year/month/day)
 - MM/DD/YYYY (month/day/year)
 - DD/MM/YYYY (day/month/year)
 - b. Use the [▼] or [▲] arrow keys to scroll to the desired format.
 - c. Press [ENTER] to confirm your entry.
4. The PT878 now asks you to select whether you want the time presented in a 12-hour format (for example, 11:53:23 PM) or in a 24-hour format (23:53:23).
 - a. Press [ENTER] to open the drop-down menu.
 - b. Use the [▼] or [▲] arrow keys to scroll to the 12-hour or 24-hour entry.
 - c. Press [ENTER] to confirm your entry.

6.5 Changing Date and Time Appearance (cont.)

A line at the bottom, the Date/Time, Decimal Formats, displays how the format and separator selections will appear on the screen.

Pressing the [▼] arrow key returns the PT878 to the Locale tab.

- To confirm the entries and return to Operate mode, press [F3] (OK). The PT878 returns to Operate Mode.
- To leave the window without confirming the entries, press [F2] (Cancel) or the [ESC] key. The PT878 returns to Operate Mode.

6.6 Adjusting the Contrast

For more comfortable viewing in a particular environment, the PT878 enables you to adjust the screen contrast. To adjust the screen contrast:

1. From the Meter menu, scroll to the Contrast entry and press [ENTER]. The Display Options window opens on the Display tab, as shown in Figure 80 below. (From the Format tab, press the [◀] key to move to the Display tab.) To step through each parameter, press the [▼] key.

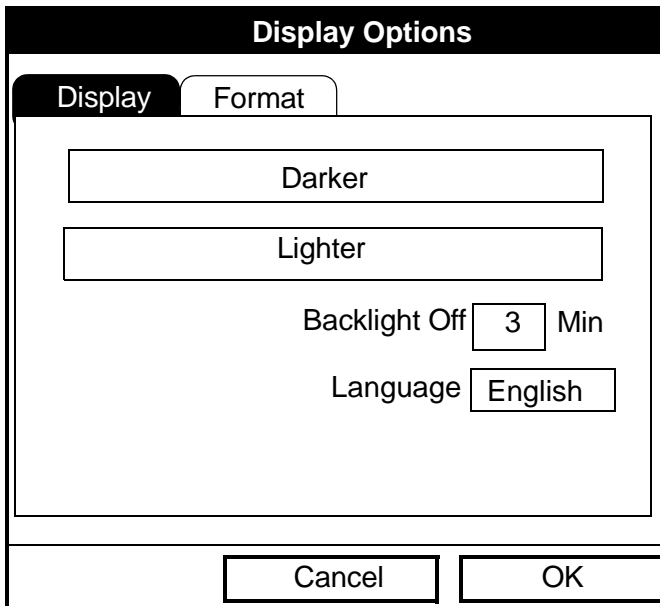

Figure 80: Display Tab in the Display Options Window

2. Scroll to the Darker or Lighter box as desired.
3. Press the [ENTER] button repeatedly until the screen has the desired contrast.

Note: *If you find the screen has become too light or too dark, scroll to the other box and press [ENTER] until you have adjusted the screen to your satisfaction.*

6.6 Adjusting the Contrast (cont.)

- To confirm the entries and return to Operate Mode, press [F3] (OK). The PT878 returns to Operate Mode.
- To leave the window without confirming the entries, press [F2] (Cancel) or the [ESC] key. The PT878 returns to Operate Mode.

6.7 Setting Backlight Timeout

By using the Backlight Timeout option, you can set a specified time that the PT878 backlight will remain on before turning itself off. Automatic turnoff enables the PT878 to conserve battery power.

To set the backlight timeout:

1. From the Meter menu, scroll to the Backlight entry and press [ENTER]. The Display Options window opens on the Display tab, as shown in Figure 80 on page 120.
 2. Press the [▼] key three times to reach the Backlight Off text box.
 3. Then press [ENTER] to enter the box.
 4. Use the numeric keys to enter the number of minutes that the backlight remains on (from 0 to 99).
 5. Press [ENTER] to confirm the entry.
- To confirm the entries and return to Operate mode, press [F3] (OK). The PT878 returns to Operate Mode.
 - To leave the window without confirming the entries, press [F2] (Cancel) or the [ESC] key. The PT878 returns to Operate Mode.

Note: *You can turn the backlight on or off at any time by pressing the power switch for 1 second.*

6.8 Changing the Display Language

Important: *To use this option, you must have previously loaded a language translation file into the PT878.*

The PT878 offers the selection of several languages for its display. To change the display language:

1. From the Meter menu, scroll to the Language entry and press [ENTER]. The Display Options window opens on the Display tab, as shown in Figure 80 on page 120.
2. Press the [▼] key four times to reach the Language prompt.
3. Then press [ENTER] to enter the drop-down menu.
4. Scroll to the desired language on the menu, here shown as either English or Francais (French).
5. Press [ENTER] to confirm the entry, and [F3] (OK) to close the option.
6. Since changing the language requires restarting the PT878, a window (shown in Figure 81 below) opens, asking that you confirm the change. Press [F2] to cancel the change or [F3] to confirm the change.

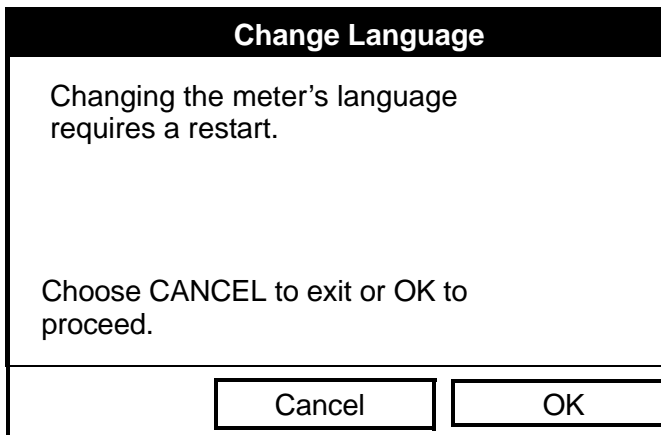

Figure 81: Confirmation Window for Language Change

6.8 Changing the Display Language (cont.)

The meter restarts in Operate Mode in the desired language. Figure 82 below illustrates a French version of the display shown in Figure 56 on page 92.

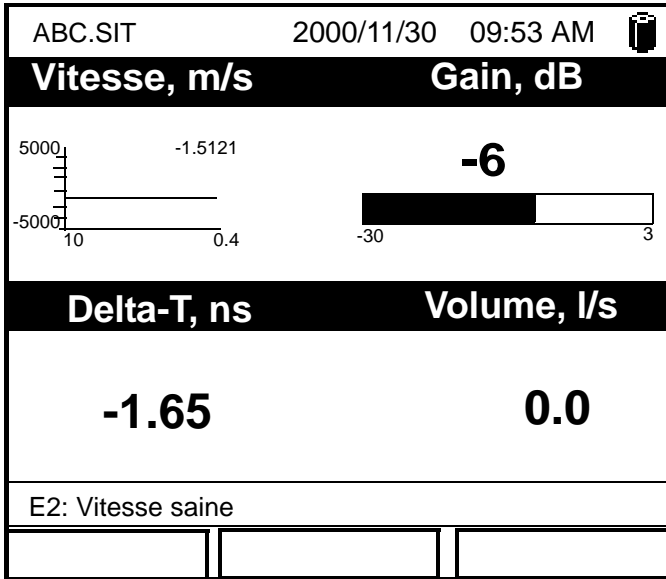

Figure 82: French Version of Typical Display

Note: *The PT878 defaults to US English. However, one or more alternate languages can be installed at any time. Consult your GE representative or www.ge-mcs.com for available languages.*

6.9 Changing Communications Settings

On occasion, you might need to change the parameters by which the PT878 communicates with a PC over the USB interface. While programming, see Figure 153 on page 237 of Appendix A, *Menu Maps*. To check or change these parameters:

6.9 Changing Communications Settings (cont.)

1. From the Meter menu, scroll to the Communications entry and press [ENTER]. The Communications window appears similar to Figure 83 below.

Communications

Node ID

Comm Interface USB

Baud Rate bps

Parity

Stop Bits 1 2

Data Bits 7 8

Figure 83: Communications Window

2. The first prompt asks for the node identification number, which can be any number from 1 to 240. *Do NOT change the node ID unless instructed by GE.*
 - a. Press [ENTER] to open the text box.
 - b. Use the numeric keys to enter the node ID.
 - c. Press [ENTER] to confirm the entry.
3. The next prompt confirms the USB communications interface.

6.9 Changing Communications Settings (cont.)

4. The program now asks for the baud rate. The default rate is 9600 bps.
 - a. Press [ENTER] to open the drop-down menu.
 - b. Use the [▼] or [▲] arrow keys to scroll to the desired rate, from 300 to 115.2K bps.
 - c. Press [ENTER] to confirm the entry.
 5. The next prompt asks for the parity from five options: None, Mark, Space, Even or Odd. The default parity is None.
 - a. Press [ENTER] to open the drop-down menu.
 - b. Use the [▼] or [▲] arrow keys to scroll to the desired parity.
 - c. Press [ENTER] to confirm the entry.
 6. The next prompt asks you to select either one or two stop bits. The default number is one. Use the [◀] and [▶] keys to scroll to the desired number, and press [ENTER].
 7. The final prompt asks you to select either seven or eight data bits. The default number is 8. Use the [◀] and [▶] keys to scroll to the desired number, and press [ENTER].
- To confirm the entries and return to Operate Mode, press [F3] (OK). The PT878 returns to Operate Mode.
 - To leave the window without confirming the entries, press [F2] (Cancel) or the [ESC] key. The PT878 returns to Operate Mode.

6.10 Resetting Forward and Reverse Totals

On occasion, it might be necessary to clear and reset the forward and reverse totals computed by the Forward and Reverse Totalizers. To reset the totals:

1. From the Meter menu, scroll to the Totals entry and press [ENTER]. The window now appears similar to Figure 84 below.

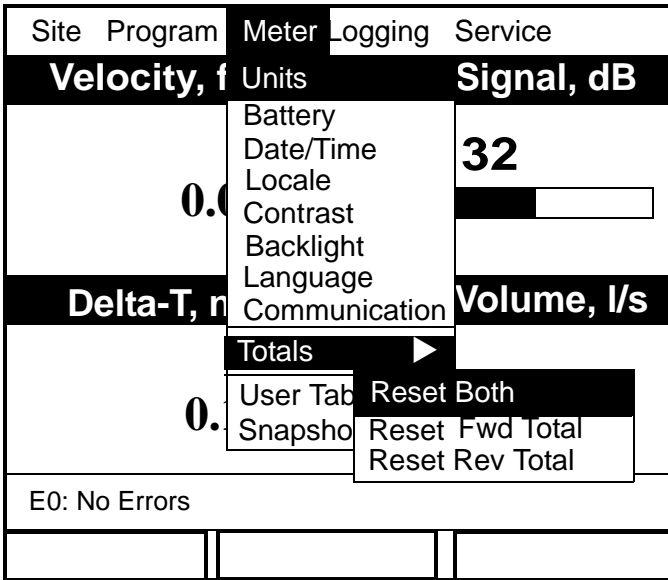

Figure 84: Resetting Totals Menu

2. Use the [▼] or [▲] arrow keys to choose the total to be reset.
3. Press [ENTER] to reset the total(s).

The meter resets the selected total(s) to 0.0 and returns to Operate Mode.

6.11 Setting Up User Tables

When you program user functions (see page 61), you can also support them with up to six user tables of non-linear or empirical data. To program one or more user tables:

1. From the Meter menu, scroll to the User Tables entry and press [ENTER]. The window now appears similar to Figure 85 below.

The screenshot shows a window titled "User Function Tables". It contains the following elements:

- Table:** A text box containing "Table 1".
- Table ID:** A text box containing "UserTable1".
- # Data Points:** An empty text box.
- Max Points:** An empty text box.
- Edit Tables:** A button located below the input fields.
- Cancel:** A button at the bottom left of the window.
- OK:** A button at the bottom right of the window.

Figure 85: User Tables Window

2. The first prompt asks you to select the table to be programmed.
 - a. Press [ENTER] to open the drop-down menu.
 - b. Use the [▼] or [▲] arrow keys to scroll to the table you wish to program.
 - c. Press [ENTER] to confirm the entry.

6.11 Setting up User Tables (cont.)

3. The next step is to create a Table ID.
 - a. Press [ENTER] to open the window. The screen now appears similar to Figure 86 below.

UserTable1									
A	B	C	D	E	F	G	H	I	J
K	L	M	N	O	P	Q	R	S	T
U	V	W	X	Y	Z	0	1	2	3
4	5	6	7	8	9	.	,	"	'
=	<	>							

Figure 86: Text Creation Window

- b. Use the four arrow keys to scroll to the desired letter or symbol, and press [ENTER] to add the letter to the label.
- Note:** *Pressing [SEL] causes the screen to alternate between a set of upper-case (capital) letters and a set of symbols. Use both screens to create the desired label.*
- c. Repeat this procedure for each letter or symbol you wish to add to the label. If you wish to delete a letter, press [F1] (Delete) to erase each letter or symbol, from right to left on the label.
 - d. When you have completed the label, press [F3] (OK) to confirm the label, or [F2] (Cancel) to leave the window without adding the label.
- Note:** *It is not necessary to enter the “#Data Points” or “Max Points” text boxes.*

6.11 Setting up User Tables (cont.)

4. The final prompt asks you to enter or change data in the user table.
 - a. Press [ENTER] to open the window. The screen appears similar to Figure 87 below.

Edit User Table 1		
	UserTable1	Y
1		
2		
3		
4		
5		
<div style="display: flex; justify-content: space-around; align-items: center;"> <div style="border: 1px solid black; padding: 5px 20px;">Cancel</div> <div style="border: 1px solid black; padding: 5px 20px;">OK</div> </div>		

Figure 87: Edit User Table Window

- b. Use the four arrow keys to move to the desired entry in the table.
- c. Press [ENTER]. Then use the numeric keys to enter the desired data, which appears in the right corner of the window above the table.
- d. Press [ENTER] to confirm the data, which then appears in the appropriate slot in the table.
- e. Repeat steps b, c and d on the previous page 129 until you have completed entering data for the table.
- f. When you have finished, press [F3] (OK) to confirm the entries or [F2] (Cancel) to leave the window without confirming the table.

6.11 Setting up User Tables (cont.)

The program returns to the Edit Tables window.

- To confirm the entries and return to Operate Mode, press [F3] (OK). The PT878 returns to Operate Mode.
- To leave the window without confirming the entries, press [F2] (Cancel) or the [ESC] key. The PT878 returns to Operate Mode.

6.12 Taking a Bitmap Capture of a Current Screen

The Snapshot option enables you to take a screen capture of the current screen in bitmap format (.bmp) for display or storage in a Windows-based PC. To take a “snapshot” of the screen:

1. From the Meter menu, scroll to the Snapshot entry and press [ENTER].
2. Another menu opens with two entries: Off and To File. Scroll to the desired entry and press [ENTER].

Note: *An icon of a camera (for file capture — see page 19) appears at the far right of the status tray, indicating that you have activated the Snapshot option. Figure 76 on page 112 shows a screen with the Snapshot option activated.*

3. To capture a screen, press the [.] (decimal) button in the lower left corner of the keypad twice. The meter beeps, indicating that it has made a screen capture.

The captured file appears as “Screen 0X.bmp” in the Drive Manager (see page 102). To transfer the file to a PC, follow the instructions in *Transferring a File to a PC* on page 104.

Chapter 7. Logging Data

A powerful and flexible feature of the PT878 is data logging. The meter enables you to choose up to 12 parameters to log. Log files contain diagnostic and measurement data as programmed by the user. The log file is typically programmed in the PT878 Log Manager, but it can also be programmed using PanaView. You can also select the start time and date, end time and date, and time interval. Logs can run one at a time or simultaneously. Error and circular logs are also available. The logged data is internally stored in battery-backed-up memory. A fixed amount of memory is assigned to data logging. The frequency of the time interval, the length of the log run, and the number of logs affect the amount of memory required for a particular log. For example, a log that records every 5 seconds will use up more memory than a log that records every 5 minutes for a given amount of time. Once you make your data logging selections, the PT878 enables you to view the amount of memory left. You may also stop logging or view logged data while or after data is logged.

This section describes:

- How to enter the Logging Menu.
- How to set up a new log.
- How to view the data logger memory.
- How to start, stop or pause logging

7.1 Entering the Logging Menu

To enter the Logging Menu, press the [MENU] key at the lower right of the PT878 keypad. The Main Menu replaces the Status Bar at the top of the screen. Press the [▶] arrow key three times to scroll from the Site Menu to the Logging Menu. At the Logging Menu, press [ENTER]. The screen appears similar to Figure 88 below. Refer to Figure 141 on page 224 of Appendix A, *Menu Maps*.

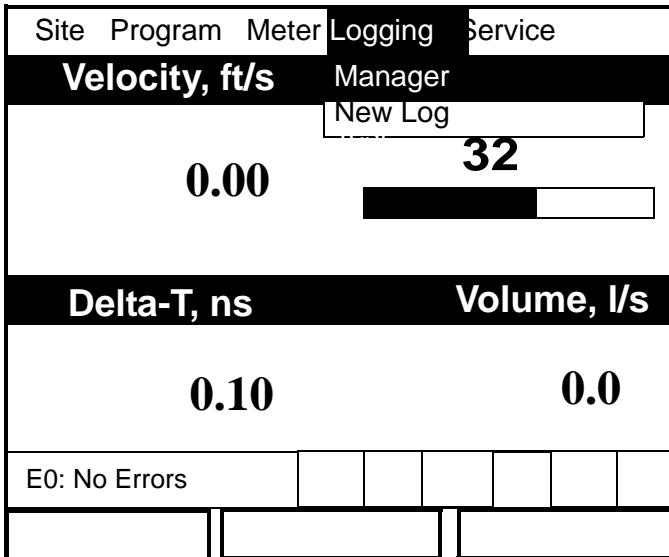

Figure 88: Logging Menu

To scroll to a particular option, press the [▼] or [▲] arrow keys until you reach the option. Then press [ENTER] to open the option window.

When entering parameters in an option, press:

- The [▼] key to step through the available parameters
- The [▲] key to scroll back to a previously entered parameter
- The [F2] key (Cancel) or the [ESC] key to exit an option at any time and return to Operate Mode without changing the parameters.

7.2 The Log Manager

The Log Manager offers users a way to check the status and memory size of all the logs currently pending, running or finished. To select Log Manager, scroll to the Manager entry on the Logging Menu and press [ENTER]. The screen appears similar to Figure 89 below. The right section of the screen supplies information for the log highlighted in the list on the left. You can use the [▼] and [▲] arrow keys to scroll to a particular log and display information pertaining to that log.

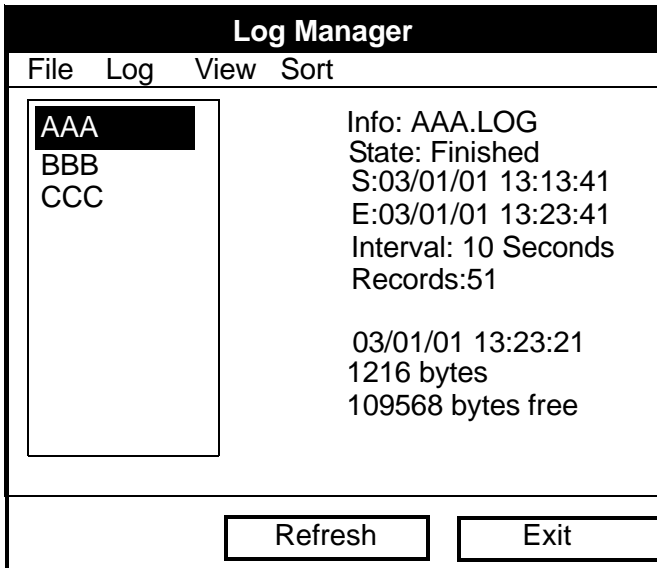

Figure 89: Log Manager Window

To access the menu for the Log Manager, press the [MENU] key. The cursor highlights the File Menu in the upper left corner. Use the [◀] and [▶] keys to scroll to the desired menu, and press [ENTER] to open the menu.

7.3 The File Menu

The File menu allows you, not only to create new logs, but also to copy, rename or delete logs, as well as to print them or transfer them to a PC. To open the File Menu from the Log Manager, press the [MENU] key and then [ENTER]. The screen appears similar to Figure 90 below.

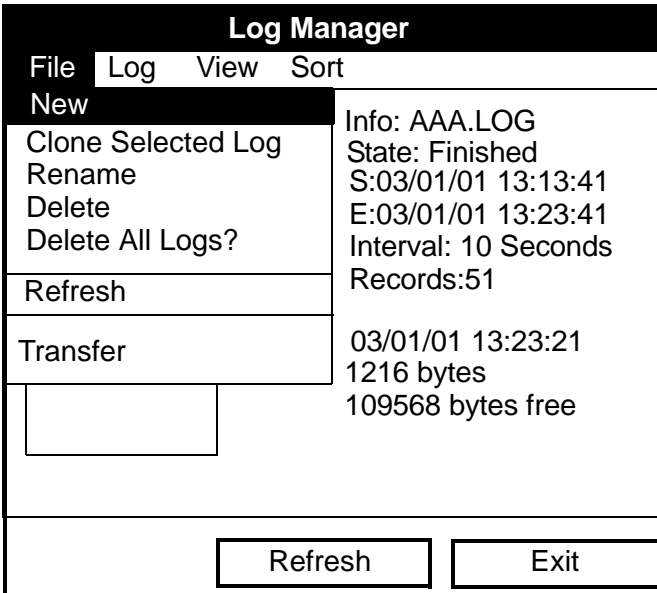

Figure 90: File Menu in the Log Manager

7.3.1 Setting up a New Log

The New Log option enables you to create and set up parameters for a new log. You can access this option in two ways:

- by scrolling to the New Log option in the Logging Menu (as shown in Figure 88 on page 132) and pressing [ENTER], or
- by scrolling to the New option in the File Menu of the Log Manager (as shown in Figure 90 on page 134) and pressing [ENTER].

In either case, the Create New Log screen appears similar to Figure 91 below. Use the four arrow keys to scroll to the desired letter or number, and press [ENTER]. Repeat this procedure until you have created the desired log name. (Press [F1], Delete, to remove any unwanted letters or numbers.)

When you have finished, press [F3] (OK) to confirm the entry.

Create New Log							
A	B	C	D	E	F	G	H
I	J	K	L	M	N	O	P
Q	R	S	T	U	V	W	X
Y	Z	0	1	2	3	4	5
6	7	8	9	-	_	@	#
&	()					
Delete		Cancel			OK		

Figure 91: New Log Window

The PT878 now asks for log formatting and measurements. The screen appears similar to Figure 92 on page 136.

7.3.1 Setting up a New Log (cont.)

The screenshot shows a dialog box titled "General Log Format Window". It has two tabs: "General" (which is active) and "Measurements". The "General" tab contains the following fields and controls:

- Log Name:** A text box containing "10SEC.LOG".
- Format:** Two radio buttons. "Linear" is selected (indicated by a filled circle), and "Circular" is unselected (indicated by an empty circle).
- Type:** Two radio buttons. "Standard" is selected (indicated by a filled circle), and "Error" is unselected (indicated by an empty circle).
- Start Date/Time:** Two text boxes. The first contains "2000/11/01" and the second contains "01:38:08".
- End Date/Time:** Two text boxes. The first contains "2000/11/01" and the second contains "09:38:08".
- Logging Interval:** A text box containing "10" followed by the label "secs".

At the bottom of the dialog box are two buttons: "Cancel" and "Activate".

Figure 92: General Log Format Window

To step through each parameter, press the [▼] key.

1. The first prompt asks you to choose between a linear or circular format for the log.
 - a. Use the [◀] and [▶] keys to scroll to the appropriate radio button.
 - b. Press [ENTER] to confirm your selection.
2. The next prompt asks you to choose whether the log is to be a standard or error log.
 - a. Use the [◀] and [▶] keys to scroll to the appropriate radio button.
 - b. Press [ENTER] to confirm your selection.

7.3.1 Setting up a New Log (cont.)

3. The next prompt asks for the starting date and time.
 - a. Press [ENTER] to enter the text box. The meter highlights the first number. Use the [◀] and [▶] keys to scroll to any number you wish to change, or the [▶] key to scroll to the time box.
 - b. Two alternatives are available to change a highlighted number:
 - Use the numeric keys to enter the desired number.
 - Use the [▼] or [▲] arrow keys to scroll, in 1-digit increments, to the desired number. (For example, if the text box displays 09, pressing the [▼] key twice changes the number to 07.) You can scroll from 01 to 12 for the month and from 01 to 31 for the day (depending on the number you have selected for the month).
 - c. In either case, press [ENTER] to confirm the entry.
4. Follow the same procedure to enter the end date and time.
5. The final prompt in this window asks for the logging interval.
 - a. Press [ENTER] to open the text box.
 - b. Use the numeric keys to enter the desired interval in seconds.
 - c. Press [ENTER] to confirm the entry.
6. You have completed entering parameters in this window. To select the measurements,
 - a. Press the [▼] key to return to the Format prompt.
 - b. Then press the [▲] key to return to the General tab.
 - c. Finally, press the [▶] key to move to the Measurements tab, and press [ENTER]. The Measurements window appears similar to Figure 93 on page 138.

7.3.1 Setting up a New Log (cont.)

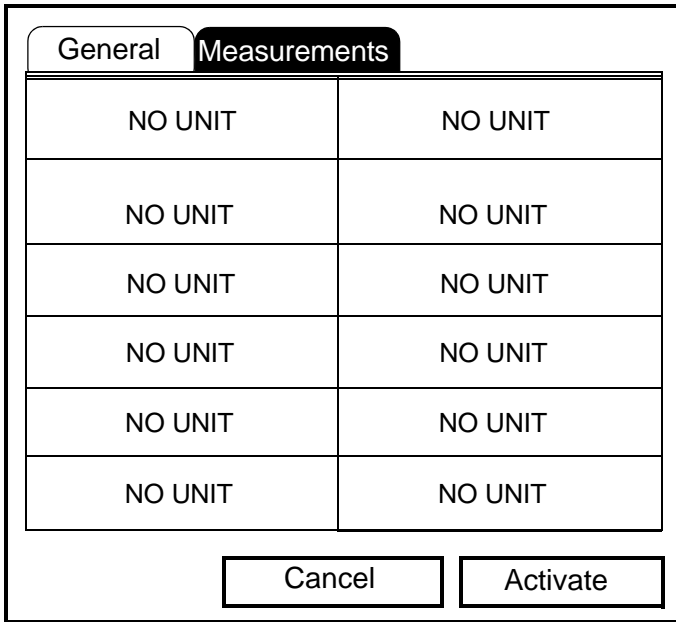

The screenshot shows a window titled "Log Measurements Window". At the top, there are two tabs: "General" and "Measurements". The "Measurements" tab is selected. Below the tabs is a table with 7 rows and 2 columns. Each cell in the table contains the text "NO UNIT". Below the table are two buttons: "Cancel" and "Activate".

General	Measurements
NO UNIT	NO UNIT
NO UNIT	NO UNIT
NO UNIT	NO UNIT
NO UNIT	NO UNIT
NO UNIT	NO UNIT
NO UNIT	NO UNIT
NO UNIT	NO UNIT

Cancel Activate

Figure 93: Log Measurements Window

To step through each entry, press the [▼] key.

1. Press [ENTER] to open the first entry. The Select Measurement window opens, as shown in Figure 94 on page 139.

7.3.1 Setting up a New Log (cont.)

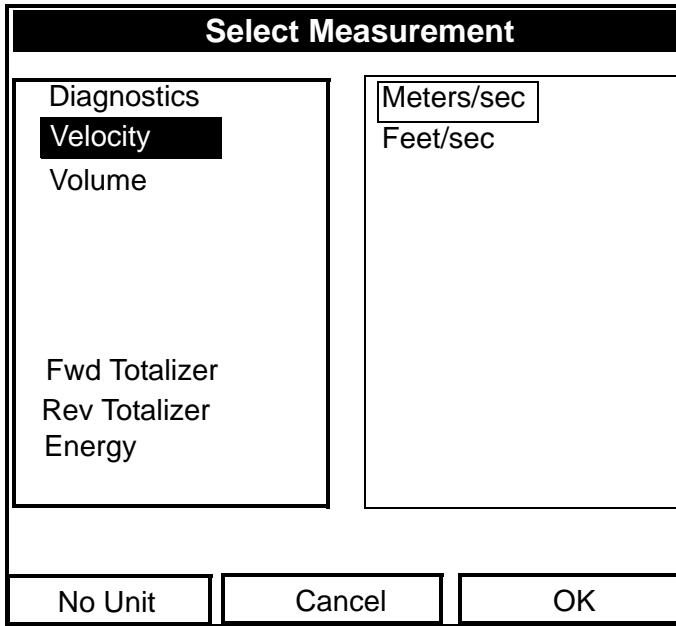

Figure 94: Select Measurement Window

2. Scroll to the desired output type.
3. Press [SEL] to confirm your selection.
4. The prompt then moves to a list of unit types. (The available units depend on the selection made at the Data Source prompt.) Scroll to the desired output unit.
5. Press [F3] (OK) to confirm your selection.
6. You can repeat this procedure for up to 12 different parameters.
7. When you have finished, press [F2] (Cancel) to cancel the entries, or [F3] (Activate) to confirm the entries and start the log.

If you started the log from the New Log option, the PT878 returns to Operate Mode, with a Pencil icon in the System Tray; if you started it from within the Log Manager, the meter returns to the Log Manager.

7.3.2 Copying (Cloning) a Selected Log

In the Clone Selected Log option, you can copy the parameters of a particular log, modify the parameters, and start the copy. To copy a log,

1. First, select the log you wish to copy in the Log Manager (shown in Figure 89 on page 133).
2. Then open the File Menu, scroll to the Clone Selected Log option, and press [ENTER].
3. The Create New Log window (see Figure 91 on page 135) opens. Follow the procedure discussed on page 135 to create a log name, and press [F3] (OK) to confirm the name.
4. The General Log Format window (shown in Figure 92 on page 136) opens. Follow the procedure discussed on page 136 and page 137 to change any settings.

Note: *Unless otherwise specified, the cloned log always begins at the current date and time, and ends after the period of time used by the original log.*

5. If you wish, scroll to the Measurements window (shown in Figure 93 on page 138) and follow the procedure discussed on page 138 and page 139 to modify any parameters.
6. When you have completed modifying the log parameters, press [F2] (Cancel) to cancel the log or [F3] (Activate) to confirm and start the new log.

The PT878 returns to the Log Manager, which now displays the status of the cloned log.

7.3.3 Renaming a Log

To rename a log:

1. First, select the log you wish to rename in the Log Manager (shown in Figure 89 on page 133)).
2. Then open the File Menu, scroll to the Rename option, and press [ENTER].
3. The Rename Log window opens. (Except for the heading, the window is identical to the Create New Log window shown in Figure 91 on page 135.) Follow the procedure discussed on page 135 to create a log name, and press [F3] (OK) to confirm the name.

The PT878 returns to the Log Manager, which highlights the renamed log.

7.3.4 Deleting a Log

To delete a log:

1. First, select the log you wish to delete in the Log Manager (shown in Figure 89 on page 133)).
2. Then open the File Menu, scroll to the Delete option, and press [ENTER].
3. A delete confirmation window opens, as shown in Figure 95 on page 142. Press [F2] (No) to stop the deletion, or [F3] (Yes) to delete the log.

The Log Manager reappears, with the specified log deleted.

7.3.4 Deleting a Log (cont.)

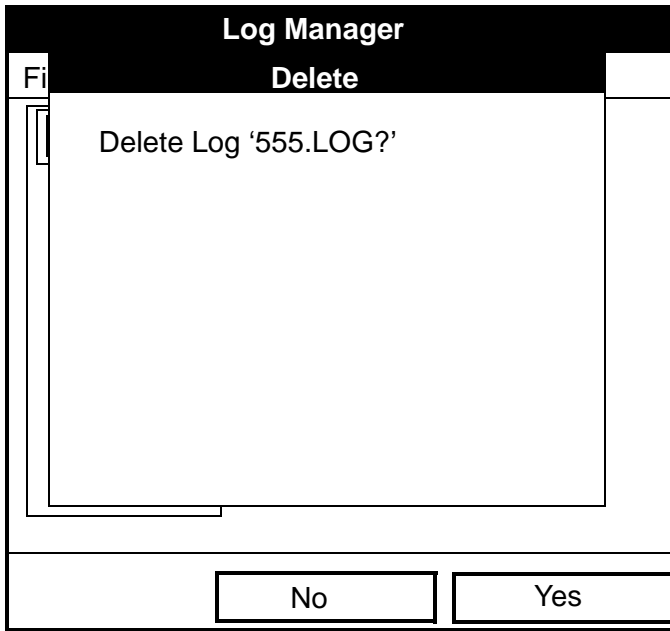

Figure 95: Delete Confirmation Window

7.3.5 Deleting All Logs

To clear the Log Manager and memory of all logs, open the File menu, scroll to the Delete All Logs option, and press [ENTER]. A window opens, asking, “Delete All Logs?” Press [F2] (No) to stop the deletion, or [F3] (Yes) to delete the logs.

A blank Log Manager appears. All logs have been deleted.

7.3.6 Refreshing the Log Manager Screen

To refresh the Log Manager screen and view the most recent information on a given log, select the log you wish to view in the Log Manager. Then open the File Menu, scroll to the Refresh option, and press [ENTER]. The screen momentarily blanks, and then reappears with the most current information on the highlighted log.

7.3.7 Transferring a Log to a PC

Log files are only required to be transferred from the PT878 to a PC. This can be accomplished via either PanaView or HyperTerminal, as text or as binary data.

7.3.7a Transfer Log Files Using PanaView

To transfer a log file from the PT878 to a PC using PanaView, complete the following steps:

1. Connect the PT878 to the PC (page 9).
2. View the available logs from the PT878 in the Meter Logs section of the PanaView Explorer window. For example, see LOG01.log in page 143 below.
3. Double click the log file and the data will be pulled into PanaView. The data can then be displayed as a Graph and saved as a PC log file. If desired, the PC log file can now be exported as a CSV file so it can be opened with Microsoft Excel®.

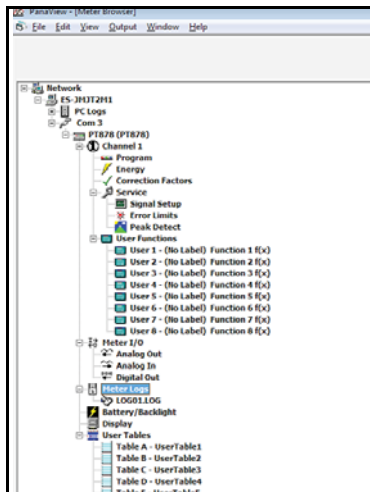

Figure 96: PanaView (Meter Browser)

7.3.7b Transfer Log Files as Text using HyperTerminal

To transfer a log file as text from the PT878 to a PC using HyperTerminal, complete the following steps:

1. Connect the PT878 to the PC(page 9).
2. Start HyperTerminal and set up the communication link to match the Com port and RS232 settings of the PT878 (see Figure 97 below).
3. From the PT878 select Logging\Log Manager and select the Log file you want to send to the PC.
4. From Log manager select File\Transfer as Text. This should print out the Log file as text to HyperTerminal.
5. To save the log file as text, from HyperTerminal proceed as follows:
 - a. Select the Transfer\Capture Text option.
 - b. Select the location and filename of the log file. Then, click Start.
 - c. Transfer the log file as text from the PT878 and then select the Transfer\Capture Text\End option from HyperTerminal.

The log file transfer as text is now complete.

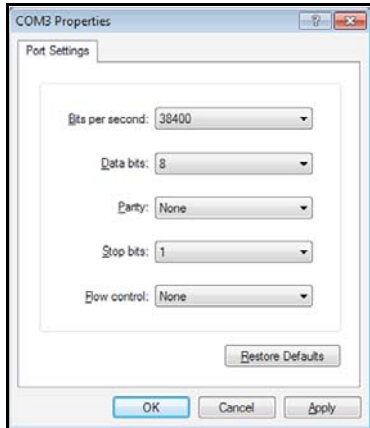

Figure 97: COM Properties

7.3.7c Transfer Log Files as Binary Data Using HyperTerminal

To transfer a log file as *binary data* from the PT878 to a PC using HyperTerminal, complete the following steps:

1. Connect the PT878 to the PC (page 9).
2. Start HyperTerminal and set up the communication link to match the Com port and RS232 settings of the PT878 (see Figure 9 below).
3. From the PT878 select Logging\Log Manager and select the Log file you want to send to the PC.
4. From Log Manager select File\Transfer as Text. This should print out the Log file as text to HyperTerminal.
5. To save the log file as binary data, from HyperTerminal proceed as follows:
 - a. Select the Transfer\Receive File option.
 - b. Select the location of the log file and select XModem as the receiving protocol.
 - c. Click Receive and enter the desired filename, using a .log extension.
6. From the PT878 Site Manager, select the File\Transfer option. This will allow the PT878 to send the log file to the PC using the secure XModem protocol. File transfer is complete when the XModem Receive dialog box closes.

Note: *The file is transferred in GE Panametrics format and it must be opened using the GE PanalogViewer software.*

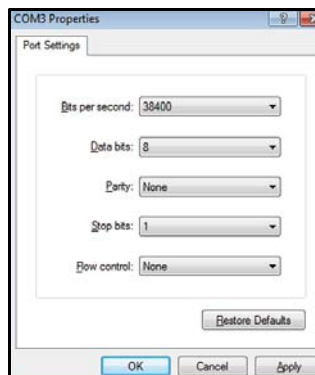

Figure 98: COM Properties

7.4 The Log Menu

The Log Menu allows you to pause, restart or end any or all logs that are currently pending or running. (However, you cannot restart any finished logs, even if they were finished before the programmed end time.) To open the Log Menu in the Log Manager, press [MENU]. Scroll to the Log option, and press [ENTER]. The window appears similar to Figure 99 below.

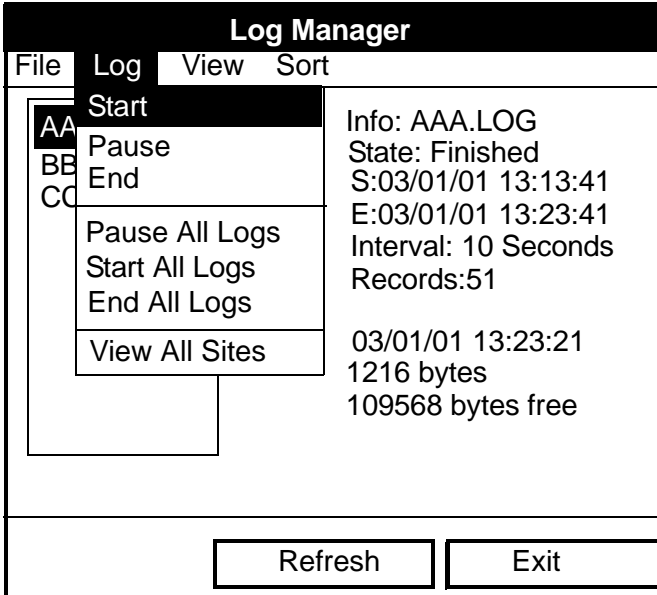

Figure 99: Log Menu in the Log Manager

7.4.1 Stopping (Pausing) a Log

To stop a log that is currently pending or running,

1. First, select the log you wish to pause in the Log Manager (shown in Figure 89 on page 133).
2. Then open the Log Menu, scroll to the Pause option, and press [ENTER].

The PT878 returns to the Log Manager, which displays the highlighted log with “Paused” in the State line.

7.4.2 Restarting a Log

To restart a paused log:

1. First, select the log you wish to restart in the Log Manager (shown in Figure 89 on page 133).
2. Then open the Log Menu, scroll to the Start option, and press [ENTER].

The PT878 returns to the Log Manager, which displays the highlighted log with a status of “Pending” or “Running.”

7.4.3 Ending a Log

To end a log:

1. First, select the log you wish to end in the Log Manager (shown in Figure 89 on page 133).
2. Then open the Log Menu, scroll to the End option, and press [ENTER].

The PT878 returns to the Log Manager, which displays the highlighted log with a status of “Finished.” The space not used by the finished log is freed for reuse.

Note: *You cannot restart a finished log. You must create a new log with the same parameters.*

7.4.4 Stopping All Logs

To stop all log that are currently pending or running, open the Log Menu, scroll to the Pause All Logs option, and press [ENTER]. The PT878 returns to the Log Manager, which displays all log programmed to run now or in the future with a status of “Paused.”

7.4.5 Restarting All Logs

To restart all paused logs, open the Log Menu, scroll to the Start All Logs option, and press [ENTER]. The PT878 returns to the Log Manager, which displays the logs with a status of “Pending” or “Running.”

7.4.6 Ending All Logs

To end all currently pending or running logs, open the Log Menu, scroll to the End All Logs option, and press [ENTER]. The PT878 returns to the Log Manager, which displays the running logs with a status of “Finished.”

7.4.7 View All Sites

To check on all logs, open the Log Menu, scroll to the View All Sites option, and press [ENTER]. Logs are associated with the site in use at the time the log is created. Thus, when another site is in use, the PT878 automatically starts different logs. By default, the Log Manager only displays the logs created with the current site. View All Sites allows the Manager to list logs for all sites.

7.5 The View Menu

Through the View menu, you can view the data of individual logs in graphical or spreadsheet formats. To open the View menu from the Log Manager, press [MENU]. Scroll to the View menu, and press [ENTER]. The screen appears similar to Figure 100 below.

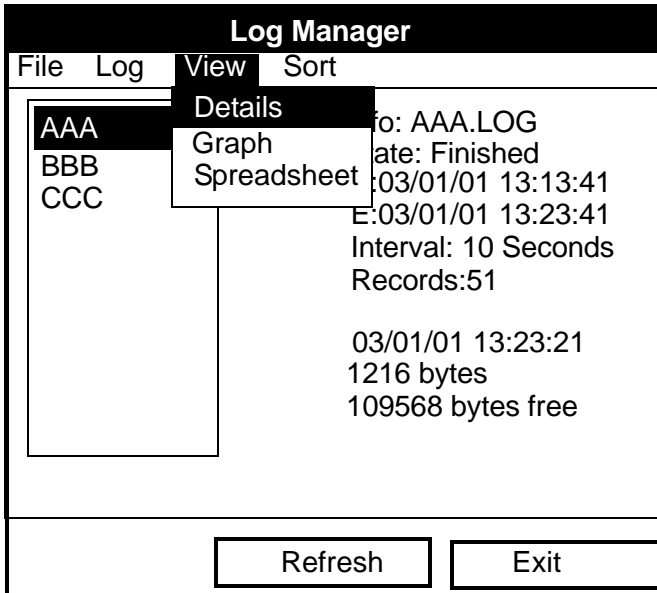

Figure 100: View Menu

7.5.1 Displaying Log Details

To view details of a given log, be sure the log is highlighted in the left window of the Log Manager. Then scroll to the View menu and press [ENTER]. Scroll to the Details option and press [ENTER]. The screen now appears similar to Figure 101 below.

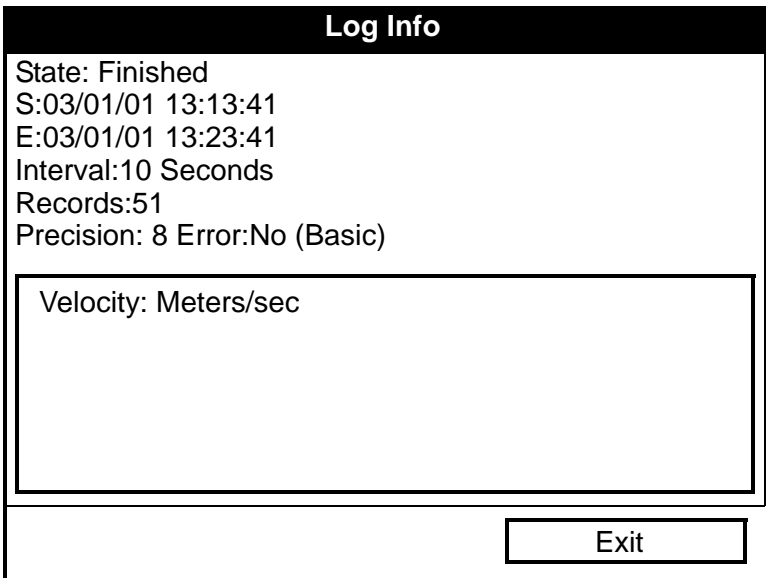

Figure 101: Log Details Display Window - List of Measurements in Log

Press [F2] (Cancel) or [F3] (OK) to return to the Log Manager.

7.5.2 Displaying Log Data in Graphical Form

To view a log in graphical form, be sure the log is highlighted in the left window of the Log Manager. Then scroll to the View menu and press [ENTER]. Scroll to the Graph option and press [ENTER].

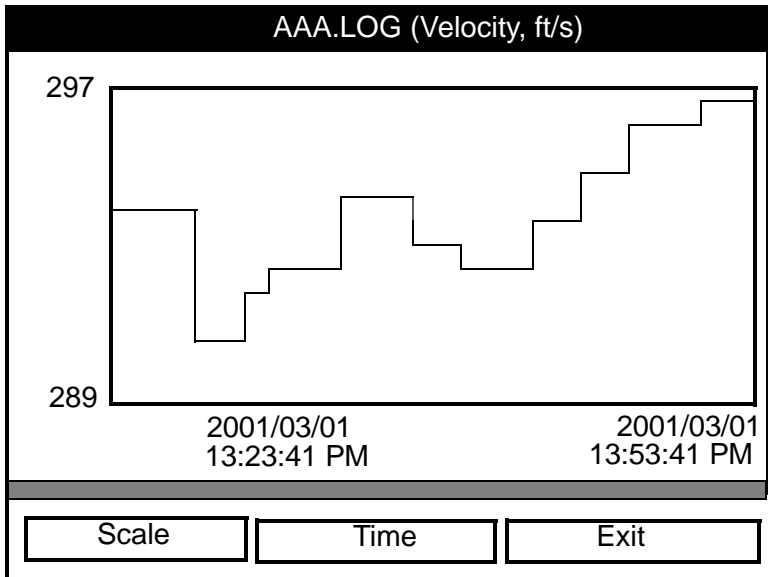

Figure 102: Log Graph Display Window

The Select Measurement window opens and lists the log measurement parameters. If a log contains more than one measurement, you must select which measurement to plot from the list displayed. Once you have chosen the measurement parameter, press [F3] (View). The screen now appears similar to Figure 102 above. (Press [F2], Cancel, to leave the window without viewing the graph.)

- If you wish to alter the graph scale, press [F1] (Scale) and go to page 152.
- If you wish to alter the time scale, press [F2] (Time) and go to page 153.
- To leave the window, press [F3] (Exit).

7.5.2 Displaying Log Data in Graphical Form (cont.)

The screenshot shows a window titled "Y-Axis" with a "Limits" section. It contains three radio buttons: "Max" (selected), "Range", and "Set". Below these are two text boxes: "Minimum" and "Maximum", both containing the value "-52". A horizontal axis with tick marks is shown below the text boxes, with the start time "2003/03/01 13:23:41 PM" and the end time "2003/03/01 13:53:41 PM". At the bottom are "Cancel" and "OK" buttons.

Figure 103: Y-Axis Window

The Y-Axis window (shown in Figure 103 above) allows you to specify whether the Y axis on the graph extends to the maximum value (Max), over the entire range (Range) or between certain specified values (Set).

1. Use the [◀] and [▶] keys to scroll to the desired limit type. Press [ENTER] to confirm the entry.

If you select Max or Range for limits, you have finished entering data in this form. If you select Set, the PT878 asks for minimum and maximum limits.

2. Press the [▼] key to reach the Minimum text box.
 - a. Press [ENTER] to open the text box.
 - b. Use the numeric keys to enter the desired value.
 - c. Press [ENTER] to confirm the entry.
3. Repeat step 2 to enter the Maximum value.
4. When you have finished, press [F2] (Cancel) to cancel the entries, or [F3] (OK) to confirm the entries and change the graph.

7.5.2 Displaying Log Data in Graphical Form (cont.)

If you wish to alter the time scale, press [F2] (Time). The Enter Time window appears similar to Figure 104 below.

AAA.LOG (Velocity, ft/s)	
Enter Time	
Start Date	Start Time
<input type="text" value="2003/03/01"/>	<input type="text" value="13:23:41 PM"/>
End Date	End Time
<input type="text" value="2003/03/01"/>	<input type="text" value="13:53:41 PM"/>

Figure 104: Enter Time Window

1. Use the arrow keys to scroll to the desired text box. Press [ENTER] to open the box.
2. Two alternatives are available to change a highlighted date or time:
 - Use the numeric keys to enter the desired number.
 - Use the [▼] or [▲] arrow keys to scroll, in 1-digit increments, to the desired number. (For example, if the text box displays 09, pressing the [▼] key twice changes the number to 07.) You can scroll from 01 to 12 for the month, from 01 to 31 for the day (depending on the number you have selected for the month), and from 0 to 59 for minutes and seconds.

In either case, press [ENTER] to confirm the entry.

3. Repeat step 2 for any other entries you wish to change.

When you have finished, press [F3] (OK) to confirm the entries and close the window, or press [F2] (Cancel) to leave the window without changing the entries.

7.5.3 Displaying Log Data in Spreadsheet Form

To view a log in spreadsheet form, be sure the log is highlighted in the left window of the Log Manager. Then scroll to the View menu and press [ENTER]. Scroll to the Spreadsheet option and press [ENTER]. The screen now appears similar to Figure 105 below.

123.LOG	
Time	Diagnostics
03/20/2001	P# Up
14:24:46	
14:24:56	450
14:25:06	448
14:25:17	451
14:25:27	453
14:25:37	450
14:25:47	449

Time	Refresh	Exit
------	---------	------

Figure 105: Log Spreadsheet Window

Use the [◀] and [▶] keys to scroll to other columns, or the [▼] or [▲] keys to scroll backward or forward in time.

- To alter the times displayed, press [F1] (Time). The Enter Time window (shown on page 153) opens. Follow the instructions on page 153 to change the date or time.
- To refresh the display, press [F2] (Refresh). The display shows the most current data.
- Press [F3] (Exit) to return to the Log Manager.

7.6 The Sort Menu

The Sort Menu within the Log Manager allows you to arrange your log list either alphabetically (By Name) or chronologically (By Date).

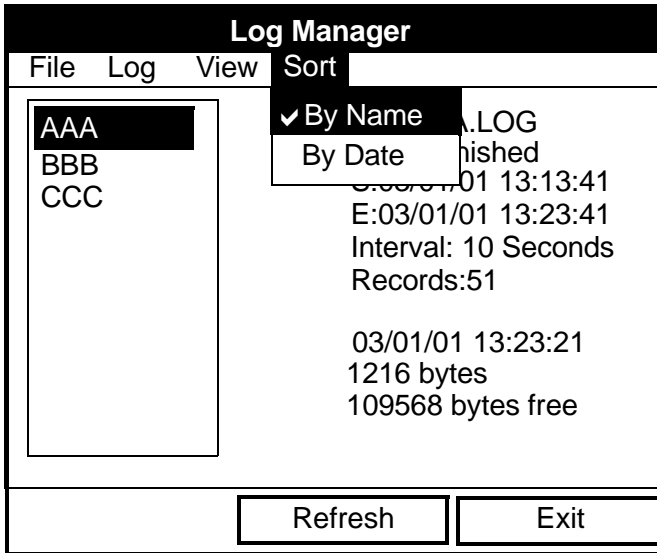

Figure 106: Sort Menu in the Log Manager

7.6.1 Listing Logs by Name

If you want to list your logs alphabetically by log name within the Log Manager, press [MENU] to open the File Menu. Then scroll from the File Menu to the Sort Menu, shown in Figure 106 above. Press [ENTER]. The Log Manager screen refreshes, with the sites listed in alphabetical order.

7.6.2 Listing Logs in Chronological Order

If you prefer to list your logs chronologically by time of creation within the Log Manager, press [MENU] to open the File Menu. Then scroll from the File Menu to the Sort Menu, and scroll to the By Date option. Press [ENTER]. The Log Manager screen refreshes, with the sites listed in chronological order, from the most recent to the earliest.

[no content intended for this page - proceed to next page]

Chapter 8. Servicing the PT878

For user convenience, the PT878 offers a Service Menu. This menu enables users to perform a variety of functions that they might occasionally require:

- output reports
- set up and view the thickness gauge measurements
- calibrate the PT878
- run diagnostics
- set up signal parameters and peak detection
- define error limits
- test the PT878 screen and keys
- diagnose setup problems with the impulse response
- check test points
- return to factory default parameters
- load updated versions of the meter program into the PT878.

8.1 Entering the Service Menu

To enter the Service Menu, press the [MENU] key at the lower right of the PT878 keypad. The Menu Bar replaces the Status Bar at the top of the screen. Press the [▶] arrow key four times to scroll from the Site Menu to the Service Menu. At the Service Menu, press [ENTER]. The screen appears similar to Figure 105 below. When programming, refer to Figure 142 on page 225 of Appendix A, *Menu Maps*.

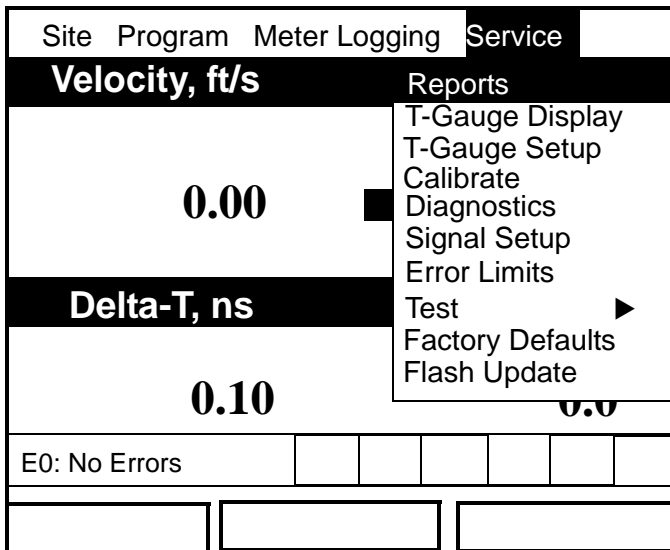

Figure 105: Service Menu

To scroll to a particular option, press the [▼] or [▲] arrow keys until you reach the option. Then press [ENTER] to open the option window.

When entering parameters in an option, press:

- The [▼] key to step through the available parameters.
- The [▲] key to scroll back to a previously entered parameter.
- The [F2] key (Cancel) or the [ESC] key to exit an option at any time and return to Operate Mode without changing the parameters.

8.2 Transferring Reports

Reports are found in the PT878 Service\Reports menu. The reports are used in troubleshooting as well as for data backup, and they may be transferred from the PT878 to a PC using HyperTerminal. Reports include:

- Drive contents
- Current site data
- Global settings
- User functions
- User tables
- Menu commands

To transfer a report as text from the PT878 to a PC using HyperTerminal, complete the following steps:

1. Connect the PT878 to the PC, as discussed on page 9.
2. Start HyperTerminal and set up the communication link to match the Com port and RS232 settings of the PT878 (see Figure 106 below).
3. From the PT878 select the Service\Reports option. Then, select the Report file you want to send to the PC and select Transfer.

8.2 Transferring Reports (cont.)

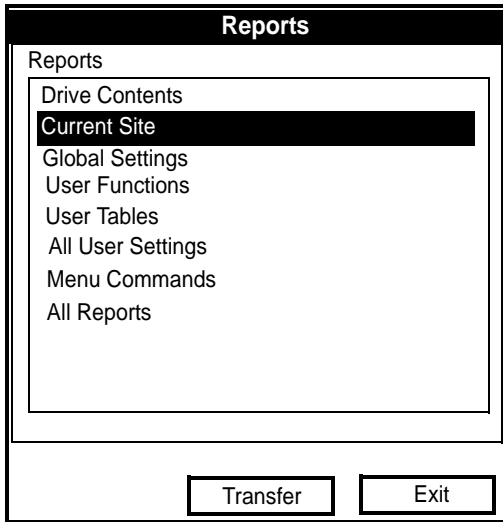

Figure 106: Reports Window

4. To save the Report as text, from HyperTerminal proceed as follows:
 - a. Select the Transfer\Capture Text option.
 - b. Select the location and filename of the Report file. Then, click **Start**.
 - c. Select Transfer Report from the PT878 and then select Transfer\Capture Text\End from HyperTerminal. The Report transfer is now complete.

8.2 Transferring Reports (cont.)

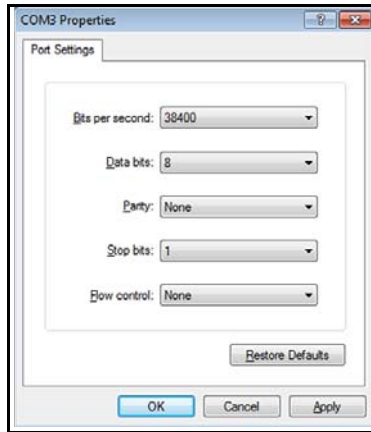

Figure 107: COM Properties

```

-----
Drive Report
-----
Bytes Free: 797696
filename      size      Date:      Time:
-----
Site Files
DEFAULT.SIT  6322     01/09/17   18:19:03
MINILOOP.SIT 7016     01/09/19   17:50:20
WETTED.SIT   7003     01/09/25   14:02:19
STC_2MHZ.SIT 6973     01/09/20   13:17:19
6INEX.SIT    6372     01/09/20   16:11:08
6INST.SIT    6369     01/09/20   16:12:01
2MHZWET.SIT  6982     01/09/26   16:49:10
500KCWET.SIT 6255     01/09/26   16:50:04
3VIEW.SIT    6226     01/09/26   16:49:03
1MHZWET.SIT  6181     01/09/26   16:49:18
4MHZCLMP.SIT 6209     01/09/26   16:49:26
Log Files
LOG01.LOG    161792   01/09/26   19:12:19
Meter Configuration Files
SYSLOG.MET   5506     01/09/26   17:10:26
GLOBAL.MET   1500     01/09/25   18:12:10
-- 1 --

```

Figure 108: Printout of a Typical Drive Report

8.3 Setting up the Thickness Gauge

For greatest accuracy in flow applications, the PT878 can measure pipe wall thickness using an optional thickness gauge transducer, instead of relying on the nominal pipe wall thickness. In Thickness Gauge mode, the PT878 does not measure flow, but it can determine the thickness of most standard metal and plastic pipe materials over a range from 0.05 to 3 in. (1.3 to 76.2 mm).

The PT878 offers two basic thickness gauge functions: using the gauge to measure thickness after entering the pipe material, and calibrating the gauge. For the highest possible accuracy, you can also calibrate the velocity of the pipe material.

Using the thickness gauge involves three steps:

1. Enter the material and soundspeed (refer to Figure 109 on page 163).
2. Measure the pipe wall thickness (in the Display window on page 165).
3. If the measurement seems unreasonable, examine the acoustic signal to diagnose the problem (in the Graph window on page 166).

Calibrating the thickness gauge involves up to two additional steps:

4. Calibrate the thickness gauge itself (in the Zero window on page 168).
5. Calibrate the velocity of the pipe material (in the Velocity window on page 171), if possible and if the pipe material is not the material entered in the Zero window. This step requires a trustworthy reference, either a section of pipe (such as a flange or open pipe section) that can be measured with calipers or another measurement device, or a thickness calibration block from the same pipe material.

8.4 Measuring Pipe Wall Thickness

8.4.1 Entering the Material and Soundspeed

Important: *The factory recommends calibrating the thickness gauge periodically (as discussed on page 168) before measuring thickness.*

To enter the Thickness Gauge Display option, scroll to the T-Gauge Display entry on the Service Menu and press [ENTER]. The screen appears similar to Figure 109 below.

The screenshot shows a software interface titled "Thickness Gauge Measure". At the top, there are five tabs: "Display", "Graph", "Velocity", "Zero", and "Material". The "Material" tab is currently selected. Below the tabs, the interface is divided into two main sections. The first section is labeled "Material" and contains a dropdown menu with the word "Other" selected. The second section is labeled "Sound Speed" and contains a numeric input field with the value "0" and the unit "m/sec" to its right. At the bottom of the window, there are two buttons: "Cancel" on the left and "OK" on the right.

Figure 109: Material Window

1. From the Thickness Gauge Display option, press the [▶] arrow key four times to enter the Material window.
2. The first prompt asks you to select the material for the pipe wall you wish to measure from a drop-down list.
 - a. Press [ENTER] to open the list.
 - b. Use the [▼] or [▲] arrow keys to scroll to the desired material.
 - c. Press [ENTER] to confirm your selection.

8.4.1 Entering the Material and Soundspeed (cont.)

If you have selected a preprogrammed material, you have completed entering data in this window. Pressing the [▼] key returns the program to the Material tab. But if you selected “Other,” you can also enter a specific soundspeed.

3. To enter the soundspeed:
 - a. Press [ENTER] to open the text box.
 - b. Use the numeric keys to enter the desired soundspeed (from the brochure *Soundspeeds and Pipe Size Data*, 914-004).
 - c. Press [ENTER] to confirm your entry.

To leave the Material window:

- Press the [◀] or [▶] arrow key to move to another tab to take readings or perform a velocity calibration.
- Press [F2] (Cancel) to return to Operate Mode without confirming the soundspeed value.
- Press [F3] (OK) to confirm the new value. The PT878 returns to Operate Mode.

8.4.2 Measuring Thickness in Numeric Format

To measure the actual thickness of a pipe, hold the calibrated transducer steady, press the [◀] or [▶] arrow key until you reach the Display tab and press [ENTER]. The T-Gauge Display option shows the thickness measurement in numeric format (displayed in Figure 110 below).

Note: Refer to Appendix D, Ultrasonic Thickness Gauge Theory of Operation, page 251, to learn how to position and align the transducer.

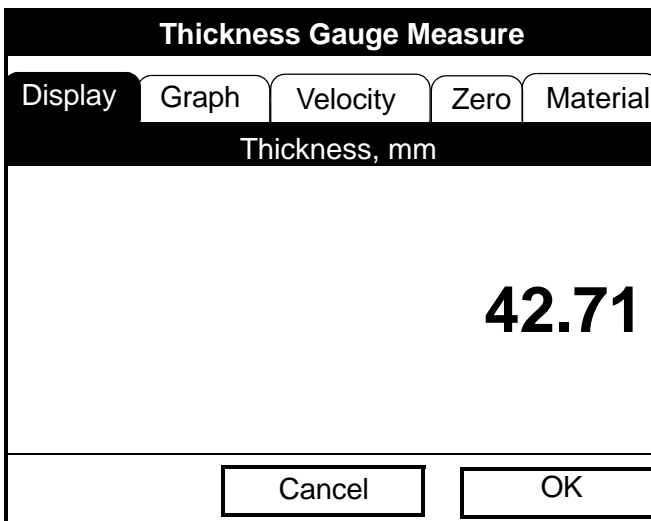

Figure 110: Thickness Gauge Display Window

Be sure the “Noise” or “Los” (loss of signal) boxes do not appear. Press [F2] (Cancel) or [F3] (OK) to return to Operate Mode, or press the [▶] arrow key to move to another window in the option.

8.4.3 Displaying the Receive Signal in Graphical Format

Used chiefly for diagnostic purposes, the Graph option helps to determine why the thickness gauge is not working if you suspect a problem. The graph shows an image of the acoustic signal. If the display does not show a signal image similar to Figure 111 below, you may have a problem with the transducer, couplant, or the programmed values. Also, some materials (such as PTFE or fiberglass) do not support acoustic signals.

To open the Graph window and display the receive signal graphically, press the [◀] or [▶] arrow key until you reach the Graph tab and press [ENTER]. The screen appears similar to Figure 111 below.

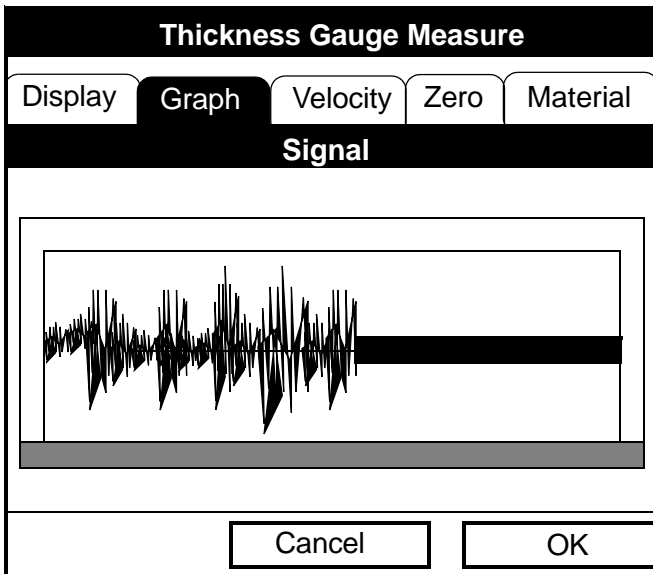

Figure 111: Thickness Gauge Graph Window

Press [F2] (Cancel) or [F3] (OK) to return to Operate Mode, or press the [▶] arrow key to move to another window in the option. However, if you wish to adjust the graph, press the [▼] key. The screen now appears similar to Figure 112 on page 167.

8.4.3 Displaying the Receive Signal in Graphical Format (cont.)

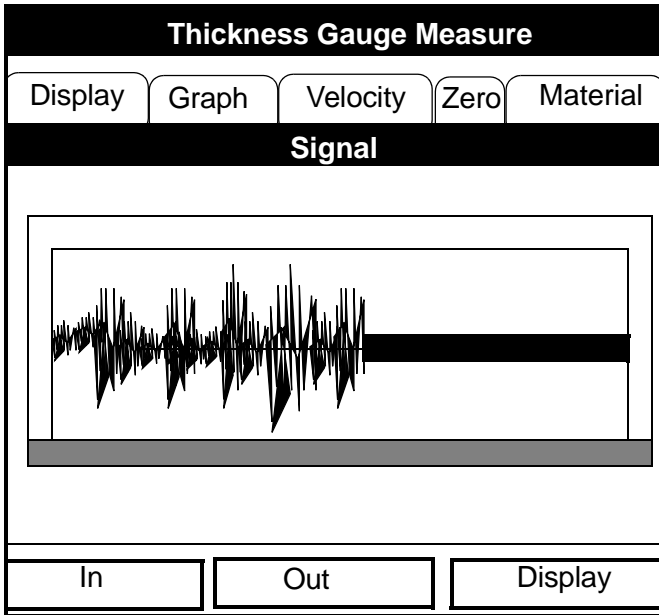

Figure 112: Graph Window in Zoom Format

- Press [F1] (In) to zoom in to magnify screen details.
- Press [F2] (Out) to zoom out fully.
- Press [F3] to toggle between the left and right cursors.
- Press [◀] and [▶] to move the selected cursor left and right.
- Press [▼] to select the graph.
- Press [▲] to return to tab navigation.
- Press [ESC] to return to Operate Mode without saving the calibration changes.

8.4.4 Calibrating the Thickness Gauge Transducer

To zero the transducer offsets, go to the Zero tab. Press the [◀] or [▶] arrow key until you reach the Zero tab and press [ENTER]. The screen appears similar to Figure 113 below.

Thickness Gauge Measure				
Display	Graph	Velocity	Zero	Material
<input checked="" type="radio"/> Single <input type="radio"/> Dual Calibration				
Block 1 Length		<input type="text" value="0"/>	mm	<input type="button" value="Calibrate"/>
Transducer Delay, μ s				
Calculated		<input type="text" value="0"/>	Current	<input type="text" value="0"/>
<input type="button" value="Cancel"/>		<input type="button" value="OK"/>		

Figure 113: Zero Window

Dual-Point Calibration

Note: *The factory recommends dual calibration. Dual-point calibration is more reliable, but it requires two known thickness levels of the calibration material. Use single-point calibration only if you know the velocity of the calibration block material to a high degree of accuracy. For single-point calibration, complete the following procedure, but skip steps 6, 7 and 8. See Appendix D for more information.*

Dual-Point Calibration (cont.)

1. Press the [▼] arrow key to enter the window.
2. The first prompt asks you to choose between single and dual-point calibration. Use the [◀] and [▶] arrow keys to move to the Dual radio button and press [ENTER].
3. The next prompt asks you to enter the length of Block 1. (If you are using a GE-supplied test block, the length is printed on the block.)
 - a. Press [ENTER] to open the text box.
 - b. Use the numeric keys to enter the length.
 - c. Press [ENTER] to confirm the entry.
4. Press [▶] to move to the Calibrate button, and press [ENTER] to prepare for calibration. Then apply couplant B to the Block 1 surface, and hold the transducer against the block.
5. When you have the transducer firmly pressed against the block and the Ready button appears, press [ENTER] again to perform the calibration.

Note: *For single-point calibration, skip to step 9.*

6. The next prompt asks you to enter the length of Block 2.
 - a. Use the arrow keys to move to the Block 2 text box.
 - b. Press [ENTER] to open the text box.
 - c. Use the numeric keys to enter the length.
 - d. Press [ENTER] to confirm the entry.
7. Press [▶] to move to the Calibrate button, and press [ENTER] to prepare for calibration. Then apply couplant B to the block surface, and hold the transducer against the block.
8. When you have the transducer firmly pressed against the block, press [ENTER] (Ready button) again to perform the calibration.
9. Hold the transducer steady until the Set button appears. Press [ENTER] to store the calibration.

Dual-Point Calibration (cont.)

Important: *Be sure to hold the transducer steady until the GE wait cursor disappears.*

10. Use the [▲] key to return to the Zero tab, and then scroll to the Display tab (page 165) to confirm the block length within ± 0.002 . If the measurement is not within this limit, recalibrate the transducer offsets.

Once you have completed calibration, the transducer should remain calibrated until the meter memory is cleared or a dramatic shift in ambient conditions occurs.

To leave the Zero window:

- Press the [◀] or [▶] arrow key to move to another tab to take readings or perform a velocity calibration.
- Press [F2] (Cancel) to return to Operate Mode without confirming the soundspeed value.
- Press [F3] (OK) to confirm the new value. The PT878 returns to Operate Mode.

8.4.5 Calculating Velocity (Pipe Material Soundspeed)

The nominal soundspeed for your pipe material will give thickness measurements of reasonable accuracy. However, for greater accuracy, calibrate pipe material sound velocity.

Important: *This step is necessary only if the actual pipe material soundspeed differs from the soundspeed of the material used in the calibration block. It is possible only if you have a sample of pipe material with thickness known to a high level of precision.*

To open the Velocity window, press the [◀] or [▶] arrow key until you reach the Velocity tab and press [ENTER]. The screen appears similar to Figure 114 below.

The screenshot shows a software window titled "Thickness Gauge Measure". At the top, there are five tabs: "Display", "Graph", "Velocity", "Zero", and "Material". The "Velocity" tab is currently selected and highlighted. Below the tabs, the main area contains the following elements:

- A label "Block Length" followed by a text input field containing the number "0".
- A horizontal line separating the input field from the next section.
- The text "Determine the Sound Speed" centered above two input fields.
- The label "Calculated" followed by an empty text input field.
- The label "Current" followed by an empty text input field.
- Another horizontal line below the input fields.
- At the bottom of the window, there are two buttons: "Cancel" on the left and "OK" on the right.

Figure 114: Soundspeed Window

1. Scroll to the Velocity tab as shown in Figure 114 above. Press [ENTER].

8.4.5 Calculating Velocity (Pipe Material Soundspeed) (cont.)

2. To enter the block length (here, the thickness of the sample as measured with a caliper or calibrated sample), press the [▼] arrow key and then press [ENTER] to open the Block Length text box. Use the numeric keys to enter the desired block length. Press [ENTER] to confirm the entry.
3. Prepare the sample for calibration by applying couplant B to its surface, and press [ENTER]. The screen now appears similar to Figure 115 below.
4. Hold the transducer steady against the sample, and wait for the Set button to appear.
5. To calibrate the gauge, press the [▼] arrow key to move to the Set button.
6. Press [ENTER] (Set button) to start the calibration sequence.

The screenshot shows a software window titled "Thickness Gauge Measure". At the top, there are five tabs: "Display", "Graph", "Velocity" (which is selected and highlighted in black), "Zero", and "Material". Below the tabs, the "Block Length" is set to "1" in a text box, with a black "Set" button to its right. A horizontal line separates this section from the next. Below the line, the text "Press Set to Commit Value" is centered. Underneath, there are two text boxes: "Calculated" with the value "22129." and "Current" with the value "74733.". At the bottom of the window, there are two buttons: "Cancel" and "OK".

Figure 115: Velocity Window - Calculated and Current Values

8.4.5 Calculating Velocity (Pipe Material Soundspeed) (cont.)

7. The “Calculated” box shows the thickness value measured. The PT878 asks for confirmation of the calculated and current values. Press [ENTER] to commit the calculated value, or to recalculate the value.

Note: *If you commit the calculated value, the settings in the Material window also change from the previous material to “Other” with the new soundspeed.*

To leave the Velocity window:

- Press the [◀] or [▶] arrow key to move to another tab.
- Press [F2] (Cancel) to return to Operate Mode without confirming the soundspeed value.
- Press [F3] (OK) to confirm the new value and return to Operate Mode.

8.5 Programming the Thickness Gauge

While the T-Gauge Display option allows you to program the appropriate material and soundspeed, the Thickness Gauge Setup option enables you to view or change five parameters:

- Low Signal Threshold
- Transducer Delay
- Signal Inversion
- Noise Threshold
- Detection Threshold

Note: *The thickness gauge programming settings are entered at the factory. You should not change them unless instructed by the factory.*

The Programming window appears similar to Figure 116 on page 174.

8.5 Programming the Thickness Gauge (cont.)

Thickness Gauge Setup

Programming

Low Signal Thresh %

Transducer Delay µs

Signal Inversion On Off

Noise Threshold %

Detection Threshold %

Cancel OK

Figure 116: Thickness Gauge Programming Window

1. Press the [▼] arrow key to enter the window.
2. The first prompt asks for the low signal threshold. If the signal strength falls below this value, a “Low Signal” message appears on the screen. To change this value:
 - a. Press [ENTER] to open the text box.
 - b. Use the numeric keys to enter the desired value.
 - c. Press [ENTER] to confirm your entry.
3. The next value, transducer delay, represents the time the ultrasonic signal takes to travel from the meter to the pipe material surface. To change this value:
 - a. Press [ENTER] to open the text box.
 - b. Use the numeric keys to enter the desired value.
 - c. Press [ENTER] to confirm your entry.

8.5 Programming the Thickness Gauge (cont.)

4. The signal inversion prompt enables you to invert the thickness transducer signal. Signal inversion may be necessary if your thickness readings show unusual jitter, or for certain unusual combinations of pipe and fluid or pipe and lining. Consult the factory before measuring the thickness of lined pipes.

Note: *When measuring the thickness of certain pipe materials, you might need to drain the pipe before measuring the pipe wall, because certain pipe/liquid combinations muffle the ultrasonic echo.*

Signal inversion should be on, unless you have received other instructions. To change its status, use the [◀] and [▶] arrow keys to move to the appropriate radio button and press [ENTER].

5. To enter the noise threshold:
 - a. Press [ENTER] to open the text box.
 - b. Use the numeric keys to enter the desired value.
 - c. Press [ENTER] to confirm your entry.
6. The final value, the detection threshold, represents the percent of peak the PT878 uses to make measurements. It will consider anything above the entered percentage as part of the signal. To change this value:
 - a. Press [ENTER] to open the text box.
 - b. Use the numeric keys to enter the desired value.
 - c. Press [ENTER] to confirm your entry.

You have finished entering values for the Programming window. To leave this window:

- Press the [◀] arrow key to move to the Materials tab.
- Press [F2] (Cancel) to return to Operate Mode without confirming the changes. The PT878 returns to Operate Mode.
- Press [F3] (OK) to confirm the new data and return to Operate Mode. The PT878 returns to Operate Mode.

8.6 Displaying Diagnostic Parameters

The Diagnostics option enables you to view current diagnostic parameters without having to open a display window in Operate Mode. To enter the option, scroll to the Diagnostics entry on the Service Menu and press [ENTER]. The screen appears similar to Figure 117 below.

Diagnostic Tests		
Meter Error 0x0000	Up	Down
T	430.67	430.67
P#	493	493
Sig Quality	5257	4952
Amplitude	30.4	28.8
Gain	-6.5	-7.0
Count	919	897
Signal	65.9	65.9
Soundspeed m/s	1503.9	
Reynolds #	500	
kRe		0.7704
Delta T		0.69
m/s		0.03
Cancel		OK

Figure 117: Diagnostics Window

Press [F2] (Cancel) or [F3] (OK) to close the window and return to Operate Mode.

Note: *For an explanation of diagnostic parameters, refer to Chapter 9, Diagnostics and Troubleshooting.*

8.7 Calibrating the Analog Output and Inputs

The Calibration option allows you to calibrate the analog output and inputs. To enter the option, scroll to the Calibrate entry on the Service Menu and press [ENTER]. The screen appears similar to Figure 118 below.

Calibrate/Test I/O

Analog Output Analog Input

Setpoint

4 mA 20 mA

Actual 4 mA Actual 20 mA

Figure 118: Outputs Window in the Calibration Option

8.7.1 Calibrating the Analog Output

The calibration procedure consists of calibrating the analog output zero point (0 or 4 mA) and then calibrating the full scale point (20 mA). You enter, first the setpoint, and then the actual value derived from an ammeter or digital voltmeter. The analog outputs have a resolution of $\pm 5.0 \mu\text{A}$. Press the [▼] arrow key to enter the Analog Output window.

8.7.1 Calibrating the Analog Output (cont.)

1. Connect the digital multimeter to the analog output.
2. The next prompt asks for the setpoint (4 or 20 mA). Use the [◀] and [▶] arrow keys to move to the appropriate radio button and press [ENTER].
3. The next prompt asks you to enter the actual value shown on the multimeter or ammeter.
 - a. Press [ENTER] to open the text box.
 - b. Use the numeric keys to enter the desired value.
 - c. Press [ENTER] to confirm your entry.
4. Repeat steps 2 and 3 for the other setpoint.
5. Press the [▼] arrow key to move to the Calibrate box, and then press [ENTER] to calibrate the output.

If you are unsatisfied with the calibration, you can reset the inputs to factory defaults. Press the [▶] arrow key to move to the Reset box, and then press [ENTER] to undo the calibration.

You have completed calibrating the outputs. To leave the Output window,

- Press the [▲] key to return to the Output tab, and the [▶] arrow key to move to the Input tab.
- Press [F2] (Cancel) to return to Operate Mode without confirming the changes.
- Press [F3] (OK) to confirm the new data. The PT878 returns to Operate Mode.

8.7.2 Calibrating Inputs

To open the Inputs window, press the [▶] arrow key and press [ENTER]. The screen appears similar to Figure 119 below.

Note: *Calibrating the analog inputs requires use of a current source.*

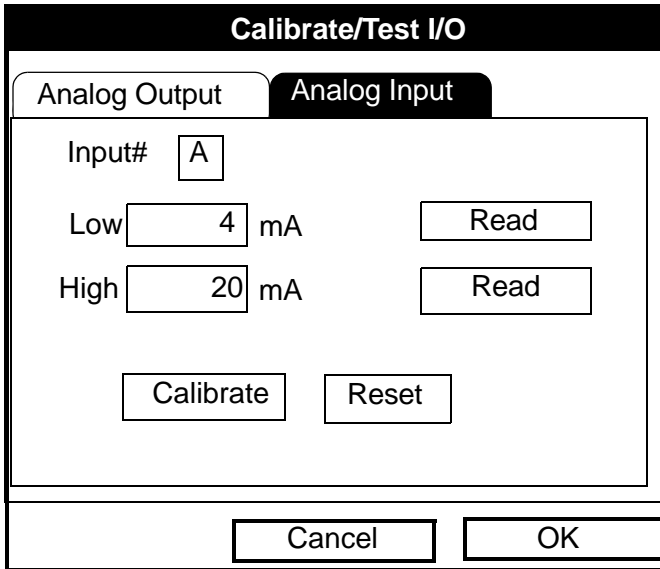

Figure 119: Inputs Window in the Calibrate Option

1. Press the [▼] arrow key to enter the window.
2. The first prompt asks you to select the input.
 - a. Press [ENTER] to open the drop-down list.
 - b. Use [▼] or [▲] arrow key to scroll to the desired output (A or B).
 - c. Press [ENTER] to confirm your selection.
3. The next prompt asks for the value to which you want to set the low input (0 or 4 mA).
 - a. Press [ENTER] to open the text box.
 - b. Use the numeric keys to enter the desired value.
 - c. Press [ENTER] to confirm your entry.

8.7.2 Calibrating Inputs (cont.)

4. Press the [▶] arrow key to move to the Read box, and then press [ENTER] to read the low input.
5. The next prompt asks for the value to which you want to set the high input (20 mA).
 - a. Press [ENTER] to open the text box.
 - b. Use the numeric keys to enter the desired value.
 - c. Press [ENTER] to confirm your entry.
6. Press the [▶] arrow key to move to the Read box, and then press [ENTER] to read the high input.
7. Press the [▼] key to move to the Calibrate box, and press [ENTER] to calibrate the inputs.
8. At this point, you have two options:
 - a. If you are unsatisfied with the calibration, you can reset the inputs to factory defaults. Press the [▶] arrow key to move to the Reset box, and then press [ENTER] to undo the calibration.
 - b. If you are satisfied with the calibration, press the [▼] key to return to the Input# prompt, and repeat steps 2 through 8 for the other input.

You have completed calibrating the inputs. To leave the Inputs window,

- Press the [▲] key to return to the Inputs tab, and the [◀] arrow key to move to the Outputs tab.
- Press [F2] (Cancel) to return to Operate Mode without confirming the changes.
- Press [F3] (OK) to confirm the new data. The PT878 returns to Operate Mode.

8.8 Setting up Signal Parameters

The Signal Setup option enables you to set parameters that affect the transducer signal:

- Delta-T Offset
- Transmit Sample Size
- Zero Cutoff
- Velocity Averaging
- Errors Allowed
- Peak Detection Method
- Peak Thresholds
- Transmit Code

To enter the option, scroll to the Signal Setup entry on the Service Menu and press [ENTER]. The screen appears similar to Figure 120 below.

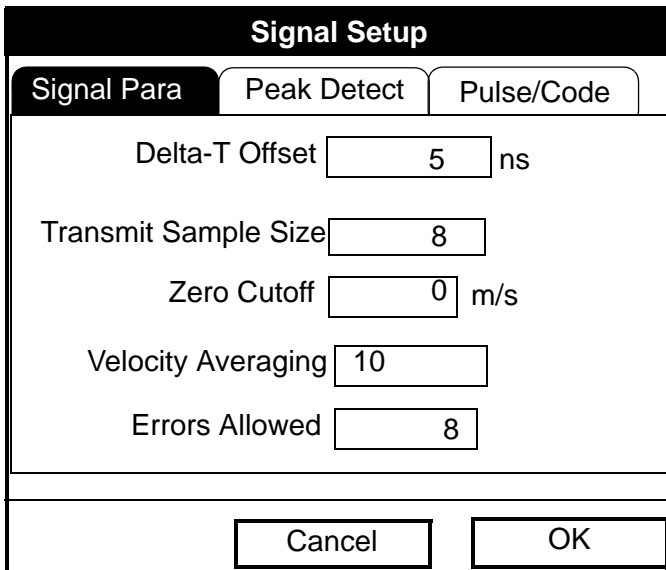

The image shows a 'Signal Setup' window with three tabs: 'Signal Para', 'Peak Detect', and 'Pulse/Code'. The 'Signal Para' tab is selected. The window contains the following parameters and values:

Parameter	Value	Unit
Delta-T Offset	5	ns
Transmit Sample Size	8	
Zero Cutoff	0	m/s
Velocity Averaging	10	
Errors Allowed	8	

At the bottom of the window are two buttons: 'Cancel' and 'OK'.

Figure 120: Signal Parameter Window

8.8.1 Setting up Signal Parameters

1. Press the [▼] arrow key to enter the window.
2. The first prompt asks for the Delta-T offset. Delta-T is the difference between the upstream and downstream transit time of the transducers. The Delta-T offset should normally be set to zero.

Note: *Consult the factory before performing this step.*

- a. Press [ENTER] to open the text box.
 - b. Use the numeric keys to enter the desired value.
 - c. Press [ENTER] to confirm your entry.
3. The next prompt, the transmitter sample size, is the number of pulses each transmitter (upstream and downstream) emits. It is set to 8 by default.

Note: *Consult the factory before performing this step.*

- a. Press [ENTER] to open the drop-down list.
 - b. Use the [▼] or [▲] arrow keys to scroll to the desired number.
 - c. Press [ENTER] to confirm your selection.
4. The next prompt asks for the zero cutoff. Near “zero” flow, the PT878 may have fluctuating readings due to small offsets (caused by factors such as thermal drift in the fluid). The zero cutoff causes velocity measurements less than the cutoff to be reported as zero. To set the cutoff:
 - a. Press [ENTER] to open the text box.
 - b. Use the numeric keys to enter the desired value.
 - c. Press [ENTER] to confirm your entry.

8.8.1 Setting up Signal Parameters (cont.)

5. The next prompt asks for velocity averaging.
 - a. Press [ENTER] to open the drop-down list.
 - b. Use the [▼] or [▲] arrow keys to scroll to the desired number of velocity measurements to average together to smooth out noise in the system.
 - c. Press [ENTER] to confirm your selection.
6. The final prompt, errors allowed, specifies the number of errors the meter can record before displaying an error message.
 - a. Press [ENTER] to open the text box.
 - b. Use the numeric keys to enter the desired value.
 - c. Press [ENTER] to confirm your entry.

You have finished entering data in the Signal Parameter window. To leave this window,

- Press the [▼] key to return to the Signal Parameter tab, and the [▶] arrow key to move to the Peak Detection tab.
- Press [F2] (Cancel) to return to Operate Mode without confirming the changes.
- Press [F3] (OK) to confirm the new data. The PT878 returns to Operate Mode.

8.8.2 Setting up Peak Detection

The PT878 can use two different methods to identify the peak of the received signal. In the “Peak” method, the peak is identified by testing a derivative of the signal. In the “Threshold” method, the peak is identified as the point where the signal crosses a threshold that is a percentage of the maximum signal detected. The peak method is more reliable in identifying the signal in dynamic conditions, while the threshold method is more reliable in marginal signal conditions.

Note: *Do not change the peak detection method or values unless recommended by the factory.*

From the Signal Parameter tab, press the [▶] arrow key to move to the Peak Detection tab. The window appears similar to Figure 121 below.

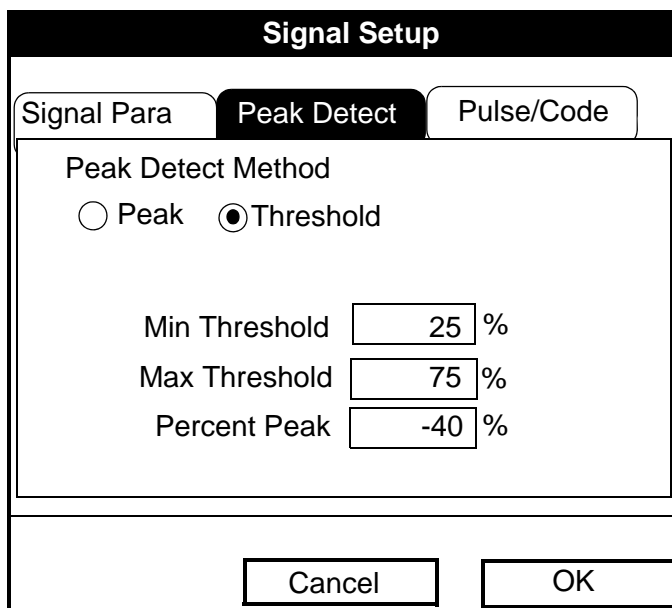

The image shows a software window titled "Signal Setup" with three tabs: "Signal Para", "Peak Detect", and "Pulse/Code". The "Peak Detect" tab is active. Inside the window, there is a section titled "Peak Detect Method" with two radio buttons: "Peak" (unselected) and "Threshold" (selected). Below this, there are three input fields with percentage labels: "Min Threshold" with a value of 25, "Max Threshold" with a value of 75, and "Percent Peak" with a value of -40. At the bottom of the window are two buttons: "Cancel" and "OK".

Figure 121: Peak Detection Window - Signal Setup Option

8.8.2 Setting up Peak Detection (cont.)

1. The first prompt asks for the peak detection method. Use the [◀] and [▶] arrow keys to move to the appropriate radio button and press [ENTER].

If you have selected the peak detection method, you have completed entering data in this window. But if you have selected the threshold method, you must also enter the minimum and maximum threshold percentage (available from 0 to 100) used to measure transit time.

2. To enter the minimum threshold:
 - a. Press [ENTER] to open the text box.
 - b. Use the numeric keys to enter the desired percentage.
 - c. Press [ENTER] to confirm your entry.
3. Repeat step 2 to enter the maximum threshold.
4. The final prompt asks for the percent of peak.
 - a. Press [ENTER] to open the text box.
 - b. Use the numeric keys (and the - key for negative numbers) to enter the desired percentage.
 - c. Press [ENTER] to confirm your entry.

You have completed entering data for Peak Detection. To leave this window,

- Press the [▲] key to return to the Peak Detection tab, and the [◀] arrow key to move to the Signal Parameter tab.
- Press [F2] (Cancel) to return to Operate Mode without confirming the changes.
- Press [F3] (OK) to confirm the new data and return to Operate Mode.

8.8.3 Selecting the Transmit Code

The Pulse/Code tab allows users to select the transmit code used by the PT878 to make measurements. The default option, “Auto,” directs the meter to select the optimal code, based on the pipe size. From the Signal Parameter tab, press the [▶] arrow key twice to move to the Pulse/Code tab, as shown in Figure 122 below.

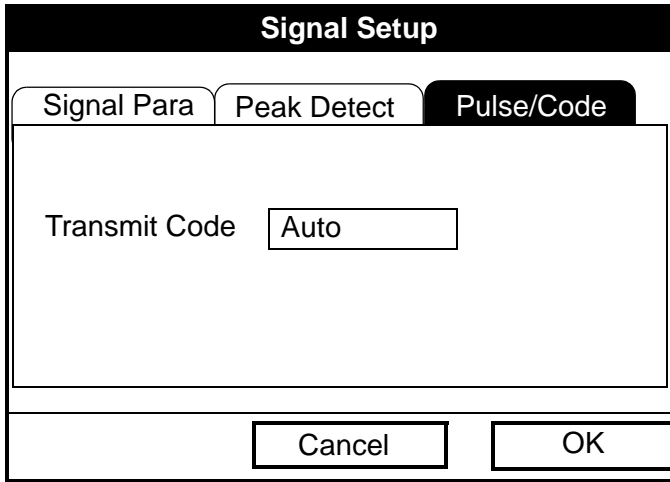

Figure 122: Pulse/Code Window - Signal Setup Option

1. Press the [▼] arrow key to reach the Transmit Code prompt, and press [ENTER] to open the drop-down menu.
2. Use the [▼] or [▲] arrow keys to scroll to the desired number of pulses (1, 2, 4, 11) or to Auto for automatic code selection.

You have completed entering the Transmit Code. To leave this window,

- Press the [▲] key to return to the Pulse/Code tab, and the [◀] arrow key to move to the Signal Parameter tab.
- Press [F2] (Cancel) to return to Operate Mode without confirming the changes.
- Press [F3] (OK) to confirm the new data and return to Operate Mode.

8.9 Setting Error Limits

The Error Limits option enables you to set limits for an incoming signal. When the signal falls outside the programmed limits, an error indication appears. To enter this option, scroll to the Error Limits entry on the Service Menu and press [ENTER]. The screen appears similar to Figure 123 below.

Signal Error Limits		
	Min	Max
Signal	<input type="text" value="40"/>	<input type="text" value="85"/>
Velocity	<input type="text" value="-12"/>	<input type="text" value="12"/> m/s
Amplitude	<input type="text" value="10"/>	<input type="text" value="34"/>
Sound Speed (\pm)	<input type="text" value="20"/>	%
Acceleration	<input type="text" value="15"/>	m/s
<input type="button" value="Cancel"/> <input type="button" value="OK"/>		

Figure 123: Signal Error Limits Option

1. The first prompt asks for the minimum and maximum limits for the transducer signal received by the PT878. The default values are 40 for minimum and 85 for maximum. The E1: LOW SIGNAL error message appears if the signal strength falls below the limit programmed here.

To enter the minimum signal

- a. Press [ENTER] to open the text box.
- b. Use the numeric keys to enter the desired value.
- c. Press [ENTER] to confirm your entry.

8.9 Setting Error Limits (cont.)

- d. Press the [▶] arrow key to move to the maximum signal box, and repeat steps a, b and c.
 - e. Press the [◀] arrow key to return to the minimum signal box, and the [▼] key to move to the next limit.
2. The next prompt calls for the low and high velocity limits. The E3: VELOCITY RANGE error message appears if the velocity falls outside these limits. Repeat Step 1 on page 187 to enter the desired limits.
3. The third prompt calls for the low and high limits for the amplitude discriminator. The discriminator measures the size of the transducer signal sent from the PT878. If the signal falls outside these limits, the E5: AMPLITUDE ERROR message appears. Repeat Step 1 on page 187 to enter the desired limits.
4. The fourth prompt asks for the acceptable limits for the soundspeed, based on conditions in your particular system. The E2: SOUNDSPEED ERROR message appears if the fluid soundspeed exceeds that entered in the Pipe option of the Program menu by more than this percentage. The default value is 20% of the nominal soundspeed.
 - a. Press [ENTER] to open the text box.
 - b. Use the numeric keys to enter the desired percentage.
 - c. Press [ENTER] to confirm your entry.
5. The final prompt asks for the acceleration limit for detecting cycle skipping. The E6: ACCELERATION ERROR message appears if the velocity changes by more than this limit from one reading to the next.
 - a. Press [ENTER] to open the text box.
 - b. Use the numeric keys to enter the desired speed.
 - c. Press [ENTER] to confirm your entry.

8.9 Setting Error Limits (cont.)

Note: *In the velocity and acceleration boxes, if the PT878 currently displays metric measurements, the F1 softkey displays the word “English.” If it displays English measurements, the F1 softkey displays “Metric.” Press [F1] to display the measurement in the alternate format.*

You have completed entering signal error limits.

- Press [F2] (Cancel) to return to Operate Mode without confirming the error limits, or
- Press [F3] (OK) to confirm the new limits and return to Operate Mode.

8.10 The Test Option

Within the Service Menu, the Test option includes seven tests to ensure that the PT878 is performing properly: Test Screen, Test Keys, Watchdog Test, Impulse Response, Wave Snapshot, Simulate and Battery Test. To enter this option, scroll to the Test entry on the Service Menu and press [ENTER]. The screen appears similar to Figure 124 below.

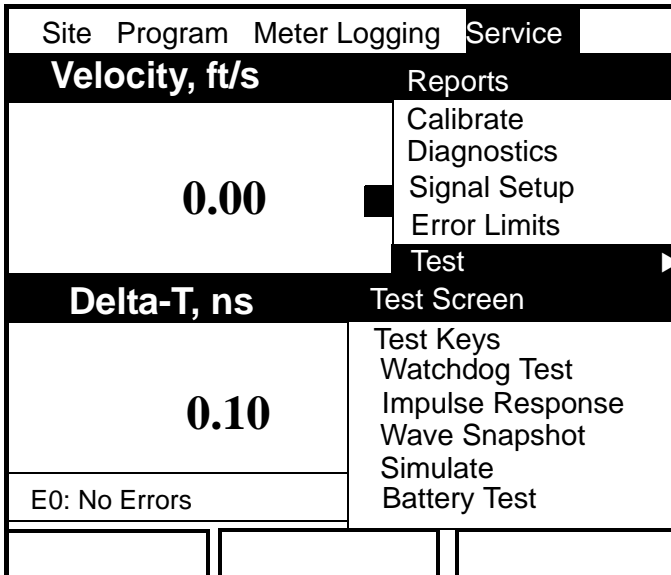

Figure 124: Test Option in the Service Menu

Scroll to the desired entry in the option menu and press [ENTER].

8.10.1 Testing the Screen

To test the proper functioning of the PT878 screen, scroll to the Test Screen option in the Test Menu and press [ENTER]. The screen then shows the message, “Press Any Key To Continue.” Once you press a key, a screen with a checkerboard pattern appears, as shown in Figure 125 below.



Figure 125: Functioning Test Screen

Pressing a key two more times should result in two more checkerboard patterns, followed by a series of dark and light screens. Pressing the key through this sequence should return the PT878 to Operate Mode. If the test does not proceed according to this sequence, please consult the factory.

8.10.2 Testing the Keys

The Test Keys option checks the functioning of the various keys on the keypad. To start the test, scroll to the Test Keys option on the Test Menu and press [ENTER]. The screen appears similar to Figure 126 below. Press any key on the keypad, and a window representing that key should darken.

Test Keys					
	F1	F2	F3		⌘
			?	ESC	SEL
1	2	3		↑	
4	5	6	←		→
7	8	9		↓	
.	0	-	MENU		ENTER
					Exit

Figure 126: Test Keys Window

Pressing the [F3] key returns the meter to the Operate Mode. If any key does not appear on the screen, contact the factory.

Note: *The power key does not appear.*

8.10.3 Testing the Watchdog Timer Circuit

The PT878 includes a watchdog timer circuit. If a software error causes the meter to stop responding, this circuit automatically resets the meter. A properly functioning PT878 restarts if you run the Watchdog Test.

To start the Watchdog Test, scroll to the Watchdog Test option in the Test Menu and press [ENTER]. The screen appears similar to Figure 127 below.

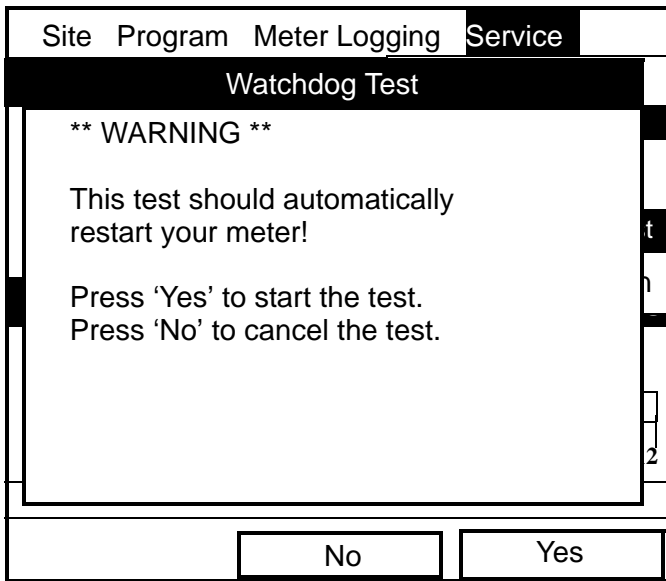

Figure 127: Watchdog Test Screen

Press [F2] (No) to cancel the test and return to the Menu screen, or press [F3] (Yes) to start the test. The PT878 should go blank for a few seconds, and then restart. If it does not follow this sequence, consult the factory.

8.10.4 Setting Impulse Response

The Impulse Response option enables you to force the meter to transmit in one direction only, without changing the AGC setting. You can then diagnose problems with transducer, pipe, or fluid configurations. To enter the option, scroll down to the Impulse Response entry in the Service Menu and press [ENTER]. The screen appears similar to Figure 128 below.

The screenshot shows a menu titled "Impulse Response" with a black header. Below the header, there are two settings: "Direction" with a dropdown menu showing "Upstream" and "Percent Gain" with a text input field showing "20" followed by a "%" symbol. Below these settings, the word "Stopped." is displayed. At the bottom of the screen, there are three buttons: "Transmit", "Stop", and "Exit".

Figure 128: Impulse Response Option

1. The first prompt asks in which direction you wish the meter to transmit, upstream or downstream.
 - a. Press [ENTER] to open the drop-down list.
 - b. Use the [▼] or [▲] arrow keys to scroll to the desired number.
 - c. Press [ENTER] to confirm your selection.

8.10.4 Setting Impulse Response (cont.)

2. The second prompt asks for the percent of gain.
 - a. Press [ENTER] to open the text box.
 - b. Use the numeric keys to enter the desired percentage.
 - c. Press [ENTER] to confirm your entry.

You have completed entering data for the Impulse Response option.

- Press [F1] to start transmitting in the chosen direction.
- Press [F2] to stop transmitting.
- Press [F3] to leave the option and return to Operate Mode.

8.10.5 Taking Wave Samples for Diagnosis

The Wave Snapshot option allows you to capture receive signals to a file that you can send to a PC for diagnostic purposes. To use this option, scroll down to the Wave Snapshot entry in the Service Menu and press [ENTER]. The PT878 then captures three pairs of upstream and downstream raw signals to a file named Wave01.met. (If you repeat the captures, the successive files will be named Wave02.met, Wave03.met, etc.) You can then transfer the files over the IR port to a PC for analysis by a service engineer.

Note: *Refer to page 104 for information on transferring a file to a PC.*

8.10.6 Transferring a Wave Snapshot

The Wave Snapshot function creates data files in the PT878 that correspond to raw and correlated data. This data is useful to review meter performance in certain applications. Wavesnapshot is generated at the PT878 UI by pressing the Service\Test\Wavesnapshot option. The file name is typically WAVExx.met, where xx is a sequential number.

To transfer a Wave Snapshot file from the PT878 to a PC using HyperTerminal, complete the following steps:

1. Connect the PT878 to the PC.
2. Start HyperTerminal and set up the communication link to match the Com port and RS232 settings of the PT878 (see Figure 129 on the next page).
3. From the PT878 select the Site\Drive Manager option and then select the WAVExx.met file you want to send to the PC.
4. To send the Wave Snapshot file, from HyperTerminal proceed as follows:
 - a. Select the Transfer\Receive File option.
 - b. Select the location of the file and select the XModem receiving protocol.
 - c. Click Receive and enter the desired filename, using the .met extension.
5. From the PT878 Site Manager select the File\Transfer option. This will allow the PT878 to send the file to the PC using the secure XModem protocol. File transfer is complete when the XModem Receive dialog box closes.

Note: *The file is transferred in GE Panametrics format and it must be opened using the DOS ConvertWave.exe program provided by GE.*

8.10.6 Transferring a Wave Snapshot (cont.)

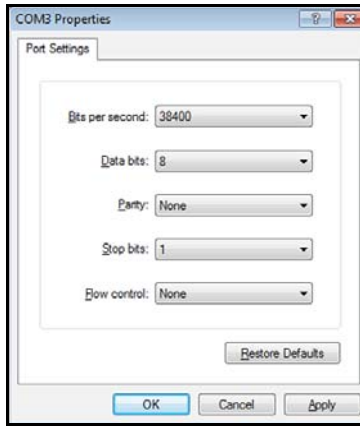

Figure 129: COM Properties

8.10.7 Testing the Battery

The Battery Test option provides additional battery information for service troubleshooting. To enter the option, scroll down to the Battery Test entry in the Service Menu and press [ENTER]. The screen appears similar to Figure 130 below.

Service Battery Form	
	Status: Fast Charge
Run Time	250 Minutes
Batt Voltage	5.78 Volts
Fast Charge	3 Min
Backup Battery: OK Batt temp 27.7 °C	
Part Number:	1.8Ahr NiCd (200-058)
Condition Battery	
Cancel	OK

Figure 130: Battery Test Option

The screen displays current status (Fast Charge, On Charge, Discharging, or On Battery), the time remaining for the PT878 to run on the battery, the time for the Fast Charge, and the current condition of the backup battery.

1. If you wish to open the Part Number window, press [ENTER]. You can choose from a 1.8 Ahr NiCd battery (part number 200-058) or a 3.0 Ahr NiMH battery (part number 200-081). Scroll to the battery type you have installed and press [ENTER].
2. To condition the batteries, press the [ENTER] key. The “Condition Battery” window should now read “Stop.” The status line should change to “Discharging.” (Updating the status could take up to 30 sec.)
3. To stop the discharge cycle, press the [ENTER] key and the “Condition Battery” window reappears. The status now changes to “On Charger.”
4. Press [F3] (OK) to return to Operate Mode.

8.11 Resetting to Factory Default Parameters

For various reasons, you might wish to return the PT878 to its original settings. The Factory Defaults option enables you to return the meter to its preprogrammed default settings. To enter the option, scroll down to the Factory Defaults entry in the Service Menu and press [ENTER]. The screen will appear similar to Figure 131 below.

Note: *All sites and logs will be lost if you use the Factory Defaults option. Be sure to transfer all sites and logs before resetting!*

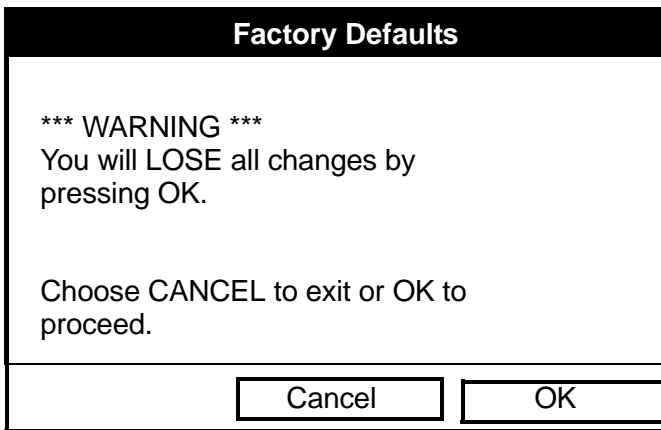

Figure 131: Factory Defaults Option

1. To restore Factory Default settings:
 - Press [F2] (Cancel) to return to Operate Mode without changing the current settings.
 - Press [F3] (OK) to confirm that you wish to restore the factory default settings.
2. The program asks for confirmation: "Are you SURE?" Repeat the procedure shown in Step 1 above.

The PT878 replaces the default site file and the global meter settings with the factory default settings, and returns to Operate Mode.

8.12 Updating PT878 Firmware

The PT878 firmware update process uses a terminal emulation program. To update the PT878 firmware using its USB interface, complete the following steps:

1. Connect the PT878 to the PC (page 9).
2. Start HyperTerminal and set up the communication link to match the Com port and RS232 settings of the PT878 (see Figure 132 below).

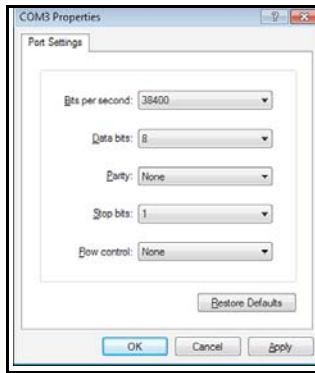

Figure 132: COM Properties

3. Power up the PT878 and press “0”. Then, press Yes to “reload Flash”.
4. In HyperTerminal, select the Transfer\Send File option and select the XModem protocol. Browse for the firmware file and select Send (see Figure 133 below).
5. After the firmware upload is complete, the PT878 will automatically reboot and perform a CRC check.

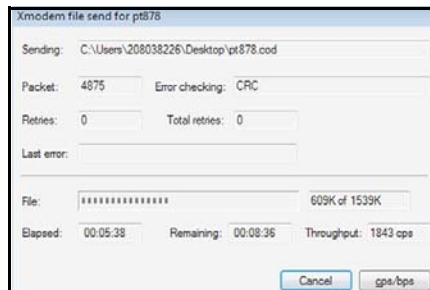

Figure 133: PT878 XModem File Send

Chapter 9. Diagnostics and Troubleshooting

The TransPort is a reliable instrument that is easy to maintain. It will provide accurate flow measurement readings as long as it is operated as described in this manual. If problems do arise with the electronics, transducers or the flowcell, the TransPort displays an error message specifying the possible problem. The TransPort also has a set of diagnostic parameters to help you find and remedy the problem.

In general, troubleshooting may be necessary if the TransPort displays an error message, the flow readings are erratic, or you have other reasons to doubt the accuracy of readings (for example, readings do not agree with other flow measuring devices connected to the same process).

This section describes error messages, diagnostic parameters, and shows you how to isolate problems to one of the following areas:

- Electronics, including programmed values
- Flowcell, which includes the pipe and fluid
- Transducers and cables.

9.1 Error Code Messages

Error Code messages appear on the screen while you are displaying measurements. When logs appear in graph form, errors are indicated by a vertical gray bar at the point of error. When they appear in a spreadsheet format, errors are indicated by their number, in place of the measurement. The Error Code messages are only general descriptions of the possible problems. Use Table 7 below to isolate and remedy the problem. If you are unable to remedy the problem, contact the factory.

Note: *We suggest that, in order to isolate the indicated problem more easily, you obtain a test flowcell. Contact the factory for details.*

Table 7: Error Messages

Error	Problem	Possible Cause	Action
E0	No error.	Displays briefly after display of another error message	None required. Measurement is valid.
E1	Low Signal - Poor ultrasonic signal strength.	Broken cable. Flowcell problem. Transducer problem. Electronic failure.	Check transducer cable. See Flowcell Problems on page 206 and Transducer Problems on page 208. Check programming and transducer spacing. Contact the factory if problem persists.
E2	Soundspeed Error (Soundspeed is programmed using the Program Menu Pipe option, as described in Chapter 5.)	Poor flow conditions. Incorrect programming. Bad transducer spacing. Measurement is very different from the programmed soundspeed.	Check soundspeed against nominal soundspeed. See Flowcell Problems on page 206 and Transducer Problems on page 208. Check programming and transducer spacing.

Table 7: Error Messages (cont.)

Error	Problem	Possible Cause	Action
E3	Velocity Range - Velocity exceeds programmed limits (Velocity limit is programmed using the Service Menu Error Limits option as described in Chapter 8.)	Programming error, poor flow conditions, or bad transducer spacing.	Make sure flow rate is within $\pm 12\text{m/s}$ ($\pm 40\text{ft/s}$). Check programming and transducer spacing. If programmed value is outside of limit, change the limits as described in Chapter 8 on page 187. See Flowcell Problems on page 206 and Transducer Problems on page 208.
E4	Signal Quality	If too high - electronic failure. If too low - flowcell, electrical problem.	Check for source of electrical interference. Check electronics with a test flowcell. If unit still fails to operate, contact the factory
E5	Amplitude Error	Excessive particles or bubbles present in fluid. A lot of second phase present	See Flowcell Problems on page 206.
E6	Cycle skip, Acceleration	Poor flow conditions or bad transducer spacing.	Check transducer spacing as programmed and as set on pipe. See Flowcell Problems on page 206 and Transducer Problems on page 208.
E7	Analog Out Error	Under current output.	Check that output load is within specification $<550\text{ ohm}$.
E8	Temperature Input Supply	Supply temperature input out of range.	Check cable and transmitter.
E9	Temperature Input Return	Return temperature input out of range.	Check cable and transmitter.

9.2 Displaying Diagnostic Parameters

As part of its measurement menu, the PT878 offers a list of diagnostic parameters to aid in troubleshooting in the event of flowcell, transducer, or electrical problems. You can select any diagnostic parameter for display as a measurement as discussed in Chapter 5, *Displaying and Configuring Data*, on page 95. Table 8 below shows all the available diagnostic parameters and ranges.

Table 8: Diagnostic Parameters

Diagnostic Parameter	Displays	Good	Bad
DT	Displays Delta T, or the difference between the upstream and downstream transit times.	N/A	Continuous large fluctuations of 1 ms or more.
Amplitude Up	Displays the value for the amplitude discriminator of the upstream transducer.	20-28	<20 or >28
Amplitude Down	Displays the value for the amplitude discriminator of the downstream transducer.	20-28 fluctuations	< 20 or > 28 fluctuations
T Up	Displays the upstream transit time of the ultrasonic signal in micro seconds.	N/A	N/A
T Down	Displays the downstream transit time of the ultrasonic signal in micro seconds.	N/A	N/A
Gain/Up	Displays upstream gain in dB.	N/A	N/A
Gain/Dn	Displays downstream gain in dB.	N/A	N/A
Soundspeed (m/s or f/s)	Displays the measured soundspeed of the fluid.	Check the soundspeed of fluid in <i>Soundspeeds and Pipe Size Data</i> .	
P#up	Displays signal peaks for the upstream transducer.	100-900	<100, >900
P#dn	Displays signal peaks for the downstream transducer.	100-900	<100, >900
Reynolds #	Displays the Reynolds Number.	N/A	N/A
K(RE)	Displays the K Factor, based on the Reynolds Number.	N/A	N/A
Raw Up	Displays raw upstream signal.	N/A	N/A
Raw Down	Displays raw downstream signal.	N/A	N/A

Table 8: Diagnostic Parameters (cont.)

Diagnostic Parameter	Displays	Good	Bad
Xmit Corr Up	Displays raw upstream signal correlated with transmit signal.	N/A	N/A
Xmit Corr Dn	Displays raw downstream signal correlated with transmit signal.	N/A	N/A
Cross Corr	Displays transmit upstream signal correlated with transmit downstream signal.	N/A	N/A
SS up	Displays the signal strength for the upstream transducer.	50-80	<50
SS do	Displays the signal strength for the downstream transducer.	50-80	<50
PEAK%	Displays the Percent of Peak. Set to -40 by default. To change see page 185.	N/A	N/A
Qup	Displays the signal quality for the upstream transducer.	±300 or higher	between ±100
Qdown	Displays the signal quality for the downstream transducer.	±300 or higher	between ±100
NFup	Displays the normalization factor for the upstream transducer.	0.85 - 1.0	<0.85
NFdn	Displays the normalization factor for the downstream transducer.	0.85 - 1.0	<0.85
TEMPs	Displays the temperature for the supply input (energy measurement).	N/A	N/A
TEMPr	Displays the temperature for the return input (energy measurement).	N/A	N/A
Ts - Tr	Displays the difference between the temperature for supply input and the temperature for return input (energy measurement).	N/A	N/A
DENSs	Displays the density for the supply input. (Energy measurement.)	N/A	N/A
DENSr	Displays the density for the return input. (Energy measurement.)	N/A	N/A
DELTh	Displays the delta enthalpy, or difference between the supply and return enthalpy (enthalpy is a measure of energy contained in the fluid.) (Energy measurement.)	N/A	N/A

9.3 Flowcell Problems

Flowcell problems fall into two categories: fluid problems and pipe problems. Read the following sections carefully to determine if such problems exist.

9.3.1 Fluid Problems

Most fluid-related problems can be solved by proper design of the flowmeter installation and the proper choice of transducer frequency. Contact the factory if you cannot solve a fluid-related problem.

Certain fluid properties may prevent proper flow measurement. Some fluid properties that cause problems are listed below.

1. **THE FLUID MUST BE HOMOGENOUS, SINGLE PHASE, RELATIVELY CLEAN, and FLOWING STEADILY.** Solid particles and gas bubbles absorb and disperse ultrasound. Although, in some cases, solids and gases have little effect on the operation of the TransPort, excessive amounts will prevent ultrasound transmission through the fluid and interfere with proper flow measurement. Temperature gradients may also cause a problem.
2. **THE FLUID MUST NOT CAVITATE NEAR THE FLOWCELL.** Fluids with a high vapor pressure may cavitate near or in the flowcell. This causes problems resulting from gas bubbles in the fluid. Cavitation can usually be controlled through proper installation design.
3. **THE FLUID MUST NOT ATTENUATE ULTRASOUND EXCESSIVELY.** Some fluids, particularly those that are very viscous, absorb ultrasound energy. In these cases an “E1” will display on the screen to indicate that the ultrasonic signal is not of sufficient strength for reliable measurements.
4. **THE FLUID SOUNDSPEED MUST NOT VARY EXCESSIVELY.** The TransPort will tolerate relatively wide, but slow, changes in fluid soundspeed due to changes in fluid composition and temperature. However, if you are measuring a fluid that is considerably different from the fluid programmed into the TransPort, you may have to adjust the meter for the new fluid. Refer to Chapter 3, *Programming Site Data*, on page 37.

9.3.2 Pipe Problems

Improper pipe conditions and/or flowcell installation can cause problems with fluid flow measurement. Check the items below if you suspect this class of problem. Contact the factory for unsolved pipe-related problems.

- 1. THE INSIDE OF THE PIPE OR FLOWCELL MUST BE RELATIVELY CLEAN.** Excessive build up of scale, rust, or debris will interfere with flow measurement. Generally, a thin coating or a solid well-adhered buildup on the pipe wall will not cause problems. Loose scale and thick coatings (such as tar or oil) will interfere with ultrasound transmission and may result in incorrect or unreliable measurements.
- 2. THE FLOWCELL ORIENTATION MUST NOT ALLOW SEDIMENT OR GAS ENTRAPMENT AT THE TRANSDUCER LOCATIONS.** Sediment or gas trapped in the transducer ports for wetted transducers, or at the transducer locations for clamp-on transducers, will interfere with flow measurement. Realignment of the flowcell or transducers often cures these problems. In some cases different transducers may be used that protrude into the flow stream.
- 3. THE PIPE OR FLOWCELL DIMENSIONS MUST BE ACCURATE.** The accuracy of your flow measurements will be no better than the accuracy of your programmed pipe or flowcell dimensions. If GE did not supply your flow cell, the dimensions you program must be consistent with the required flow accuracy. Check your pipe for wall thickness, diameter, dents, eccentricity, weld deformity, and straightness.
- 4. THE PIPE SURFACES SHOULD BE SMOOTH (FOR CLAMP-ON).** When using clamp-on transducers, both the inside and the outside of the pipe at the transducer locations must be smooth. If the pipe is extremely rough, the ultrasonic signal will be scattered by the rough surface, and will not be received by the flowmeter, preventing flow measurement.
- 5. THE PIPE MUST ALLOW ULTRASOUND TO PASS THROUGH (FOR CLAMP-ON).** Some pipe materials or linings such as Fiberglass (or generic fiber reinforced pipe), Teflon, and polyethylene, absorb ultrasound and may cause problems in clamp-on applications. Pipes with extremely thick walls or high OD to ID ratios may also present difficulties.

9.4 Transducer Problems

Ultrasonic transducers are rugged. However, they are subject to physical damage due to mishandling and chemical attack. Clamp-on transducers are also subject to installation variables such as physical misalignment and faulty coupling to the pipe on which they are mounted.

Because transducer problems are largely dependent on the type of transducer used, wetted or clamp-on, the following list of potential problems is grouped according to transducer type. Contact the factory if you cannot solve a transducer-related problem.

9.4.1 Wetted Transducer Problems

1. LEAKS

Leaks may occur around the transducer and in the fittings of the flow cell. Repair as you would any other leak. Check the transducer and cables for damage if the leaking fluid is corrosive.

2. CORROSION DAMAGE

Wetted transducers may be damaged by corrosive fluids if the transducer material does not match the application. Most often, corrosion damage occurs at the electrical connector. To check for damage, remove the transducer from the flow cell. If the wetted end of the transducer is rough and pitted, the transducer may have to be replaced. GE can supply suitable transducer materials for most fluids. Contact the factory for information on special transducers.

3. INTERNAL DAMAGE

An ultrasonic transducer consists of a ceramic “crystal” bonded to the transducer case. The bond between the crystal and the case may be damaged by extreme mechanical shock and by temperature extremes. The crystal itself can also be damaged by the same conditions. The internal wiring can be corroded or shorted if contaminants enter the transducer housing.

9.4.1 Wetted Transducer Problems (cont.)

4. PHYSICAL DAMAGE

Transducers may be physically damaged by dropping them onto a hard surface or striking them against another object. Usually the connector on the transducer is the part that is damaged, as it is the most fragile. Minor damage may be repaired by carefully bending the connector back into shape. If the connector cannot be repaired, replace the transducers. Note that transducers must be replaced in pairs. Before replacement, make sure that the transducer number in the programmed parameters is the one engraved on the new transducers (see Chapter 3, *Programming Site Data*).

9.4.2 Clamp-on Transducer Problems

1. POOR COUPLING TO PIPE

Clamp-on transducers must be in intimate contact with the pipe. The pipe wall must be smooth and generally free of paint. The couplant material must fill voids between the transducer and the pipe, and must be firmly coupled or bonded to both the pipe and the transducer. The pipe and transducer must be clean and dry for permanent couplant, such as grease or epoxy, to adhere properly. Enough pressure must be applied to the transducer by its clamp to hold it firmly against the pipe.

2. MISALIGNMENT

The transducer transmits relatively narrow beams of ultrasound, and therefore transducer alignment is critical to assure that the beam can travel from one transducer to the other without undue attenuation. Be sure to exactly follow the instructions that came with your transducers and clamping fixtures. Also, be sure that the transducer spacing agrees with the calculated spacing (S).

3. INTERNAL DAMAGE

Ultrasonic transducers consist of a ceramic “crystal” bonded to the transducer case. The bond between the crystal and the case may be damaged by extreme shock and by temperature extremes. The crystal itself can also be damaged by the same conditions. The internal wiring can be corroded or shorted if contaminants enter the transducer housing.

9.4.2 Clamp-on Transducer Problems (cont.)

4. PHYSICAL DAMAGE

Transducers may be physically damaged by being dropped onto a hard surface or being struck against another object. Usually the transducer connector is the part that is damaged, as it is the most fragile. Minor damage may be repaired by carefully bending the connector back into shape. If the connector cannot be repaired, replace the transducers. Note that transducers must be replaced in pairs, and that after replacement the flowmeter parameters should be checked (see Chapter 3, *Programming Site Data*).

5. CYCLE SKIP CONDITION

A cycle skip is usually caused by a distorted or altered signal due to poor couplant, bad wall, or unusual fluid disturbances. To resolve a cycle skip, recouple both transducers with proper couplant. Try standard CPL-1 couplant that is good to 212°F (100°C) or CPL-2 for up to 500°F (260°C). In addition, make sure the pipe wall is free of paint and rust.

Contact the factory if you cannot solve a transducer-related problem.

9.4.3 Relocating Transducers

If the coupling or pipe wall are not the problem, try relocating the transducers using the following method. However, before beginning, make sure the transducers are not located on or near pipe welds or seams:

Move one transducer about 1/2 inch (12.7 mm) closer to the other transducer. If this resolves the problem, you must modify the “S” dimension programmed into the PT878 by using the following steps:

1. Press [MENU].
2. Scroll to the Program menu and press [ENTER].
3. Scroll to the Path option and press [ENTER]. Then scroll down to the Spacing box and press [ENTER].
4. Use the numeric keys to enter the transducer spacing. Subtract 0.5 in. (12.7 mm) from the original “S” and enter the new “S” dimension.
5. Press [F3] (OK).

If this method does not resolve the problem, contact the factory.

Chapter 10. Specifications

This section contains specifications for the following:

- Overall
- Electrical
- Transducer
- Fluid Types
- Pipe Size and Materials
- Available Options

10.1 Overall

10.1.1 Hardware Configuration

Channel Options: Single channel

Mode Options: Transit-time

10.1.2 Size/Weight

Size without boot: $238 \times 138 \times 38$ mm
($9.4 \times 5.5 \times 1.5$ inches)

Weight with boot: 1.36 kg (3 lb)

10.1.3 Enclosure

Submersible, IP67

10.1.4 Flow Accuracy (Velocity, % of reading):

Clamp-on Transducers: **Pipe Diameter > 150 mm (6 in.)**

±1% to 2% of reading typical

Pipe Diameter ≤ 150 mm (6 in.)

±2 to 5% of reading typical

Note: *Accuracy depends on pipe size and whether measurement is one-path or two-path. Accuracy to $\pm 0.5\%$ of reading may be achievable with process calibration.*

Range: -12.2 to 12.2 m/s (-40 to 40 ft/s)

Rangeability: 400:1

Repeatability: $\pm 0.1\%$ to 0.3% of reading

Note: *Specifications assume a fully developed flow profile (typically 10 diameters upstream and 5 diameters downstream of straight pipe run) and flow velocity greater than 1 ft/s (0.3 m/s).*

Energy Accuracy The accuracy of the energy measurement is a combination of the accuracy of the flow and temperature measurement. Accuracy of 1% is typical for calibrated systems.

Low Voltage Directive Compliance: This unit complies with European Standard EN61010-1 Installation Category II, Pollution Degree 2.

EMC Directive Compliance: This unit complies with EN61326:1998 CL.A Annex C. For continuous unmonitored operation, follow provisions of the 89/336/EMC Compliance.

10.2 Electrical

Internal Batteries

Type: Rechargeable batteries. (Optional NiCad 6_R nonrechargeable alkaline available.)

Battery Life: 9-11 hours of continuous operation is typical

Battery Charger:

Input: 100-250 VAC, 50/60 Hz, 0.38 A

Memory: 1 MB datalog/site battery-backed RAM
1 MB program FLASH memory

Environmental

Operating

Temperature: -20 to 55°C (-4 to 131° F)

Storage

Temperature: -40 to 70°C (-40 to 158° F)

Note: *To ensure maximum battery life storage, do not exceed 35 °C (95° F) for long periods.*

Operating Modes

Flow Measurement: Transit-Time™ mode with clamp-on or wetted transducers

Energy: To calculate energy flow rate, use the external loop-powered RTD transmitter (Part # 2CHRT)

Input/Output

Keypad: 25-key rubberized tactile membrane keypad

Display: 240 × 200 pixel LCD graphic display with EL backlight

Communications: USB port

Analog Output: One 4-20 mA or 0-20 mA current output

Digital Output: One user-selectable pulse (solid-state, 5-V max.) or frequency (5-V square wave, 100 to 10,000 Hz)

Analog Input: Two 4-20 mA analog inputs with switchable 16 V supply for loop-powered temperature transmitters

Acoustic: One pair of LEMO® coaxial transducer connectors

Cable and length: Cable length 8 m (25 ft) standard. Up to 305 m (1000 ft) optional with extension cables.

10.3 Operational Specifications

Site Parameter Programming: Menu-driven operator interface using a keypad and “soft” function keys.

On-line help functions including pipe tables.
Storage for saving parameters for up to 64 sites.

Data Logging: Memory capacity to log over 100,000 flow data points.
Keypad programmable for log units, update times and start and stop times.

Display Functions: Graphic displays shows flow in numeric or graphical format. Also displays logged data.
Supports multiple languages: English, French, German, Japanese, Spanish, (Castilian and South American), Italian, Portuguese, Dutch, Russian and Swedish.

Totalizers: Pulse or frequency totalizer output.

10.4 Transducer

10.4.1 Clamp-On Ultrasonic Flow Transducers

Temperature Range:

Standard: -40° to 150°C (-40° to 300°F)

Optional (overall): -190° to 300°C (-310° to 572°F)

Housing:

Standard: None

Optional: List models or consult factory:

Mounting: SS Chain or strap, welded or magnetic clamping fixtures

10.4.2 Temperature Transducers

Types: Loop-powered 3-wire platinum RTDs; clamp-on and wetted (thermowell) types are available.

Accuracy: 0.15°C wetted RTDs (matched pairs)

Range: -20 to 260°C (-4 to 500°F)

10.5 Pipe Size and Material

10.5.1 Clamp-On Transducers:

Materials: All metals, most plastics; consult GE Sensing for concrete, composite materials and highly corroded or lined pipes

Pipe Sizes: 12.7 mm to 7.6 m outside (OD)
(0.5 to 300 in.)

Pipe Wall Thickness: Up to 75 mm (3 in.)

10.6 Available Options

Thickness Measuring Mode

Standard GE Measurement & Control
Transducer: dual element transducer

Pipe

Thickness Range: 1.3 to 76.2 mm (0.05 to 3.0 in.)

Pipe Materials: Most standard metal and plastic pipe materials

Accuracy: $\pm 1\%$ typical or ± 0.05 mm (± 0.002 in.)

Display Resolution: 0.01 mm (0.001 in.)

Thermal Continuous operation to 37°C (100°F)

Exposure: Intermittent operation to 260° C (500° F)
for 10 seconds followed by air cooling for 2 minutes.

Energy Equipment

Dual RTD transmitter; two 4 to 20-mA transmitters with input for 3-wire RTD (100 Ω Pt) and terminals for 4 to 20-mA output; and 6-ft. cable

PC Option

USB Port enables connection to desktop or laptop PCs

PC Interface Software

PanaView™ Instrument Interface Software

Appendix A. Menu Maps

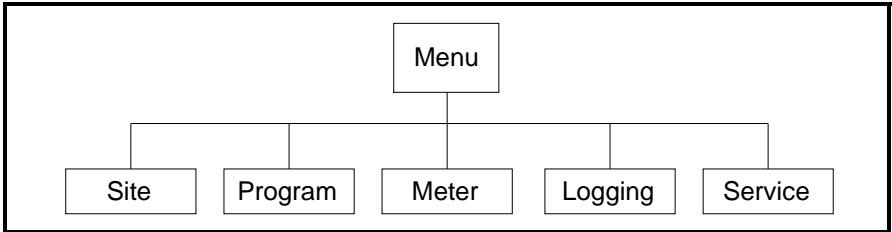

Figure 137: Main Menu

- **Site Menu** - Figure 138 on page 221.
- **Program Menu** -
 - Pipe Option - Figure 139 on page 222
 - Transducer Option - Figure 143 on page 227
 - Lining Option - Figure 144 on page 228
 - Fluid Option - Figure 145 on page 229
 - Path Option - Figure 146 on page 230
 - Energy Option - Figure 147 on page 231
 - Analog Input Option - Figure 148 on page 232
 - Analog Output Option - Figure 149 on page 233
 - Digital Output Option - Figure 150 on page 234
 - User Functions Option - Figure 151 on page 235
 - Correction Factors Option - Figure 152 on page 236
- **Meter Menu** -
 - Meter Menu - Figure 140 on page 223
 - Communications Option - Figure 153 on page 237.
- **Logging Menu** - Figure 141 on page 224.
- **Service Menu** - Figure 142 on page 225

[no content intended for this page - proceed to next page]

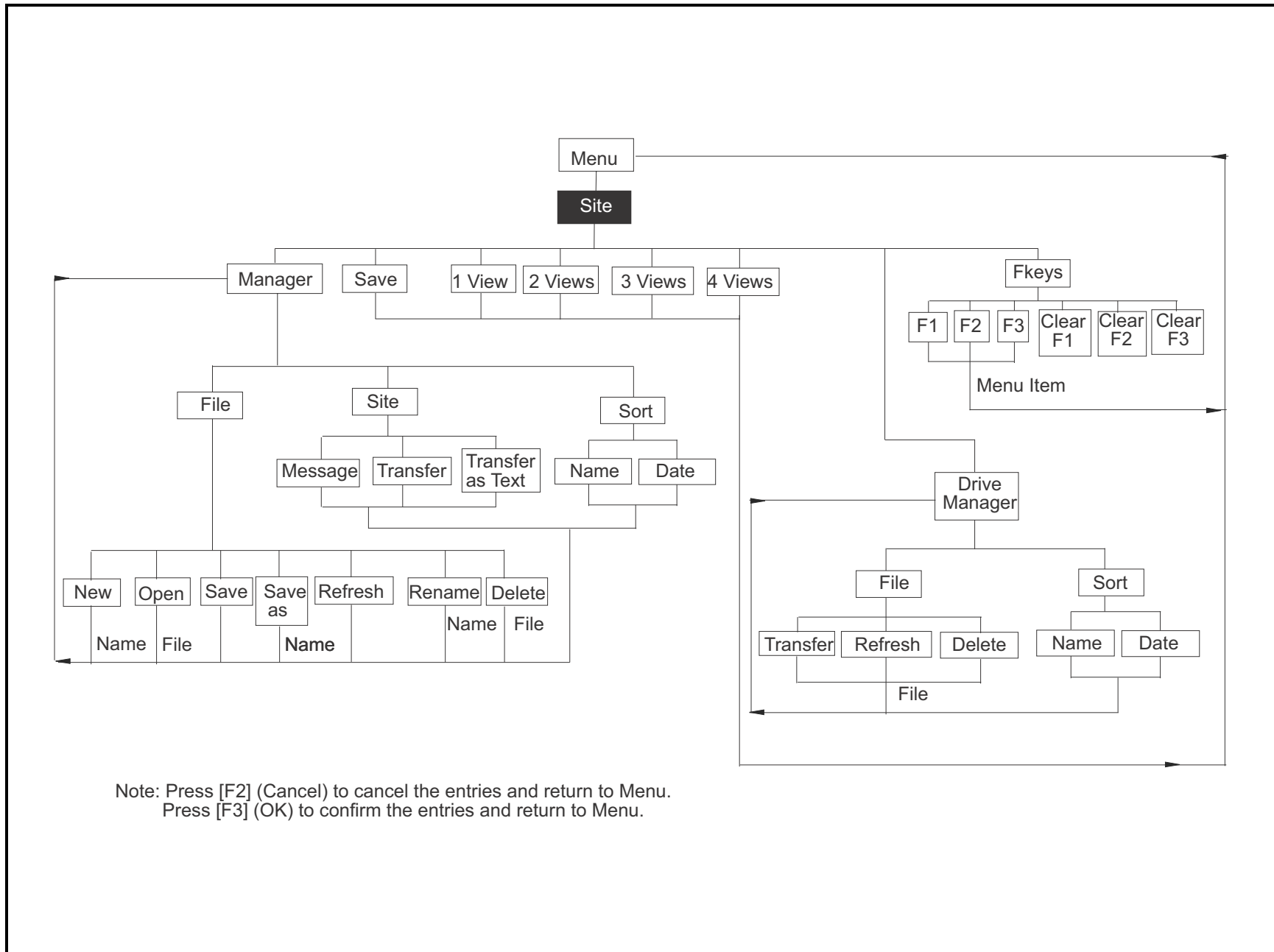

Figure 138: Site Menu

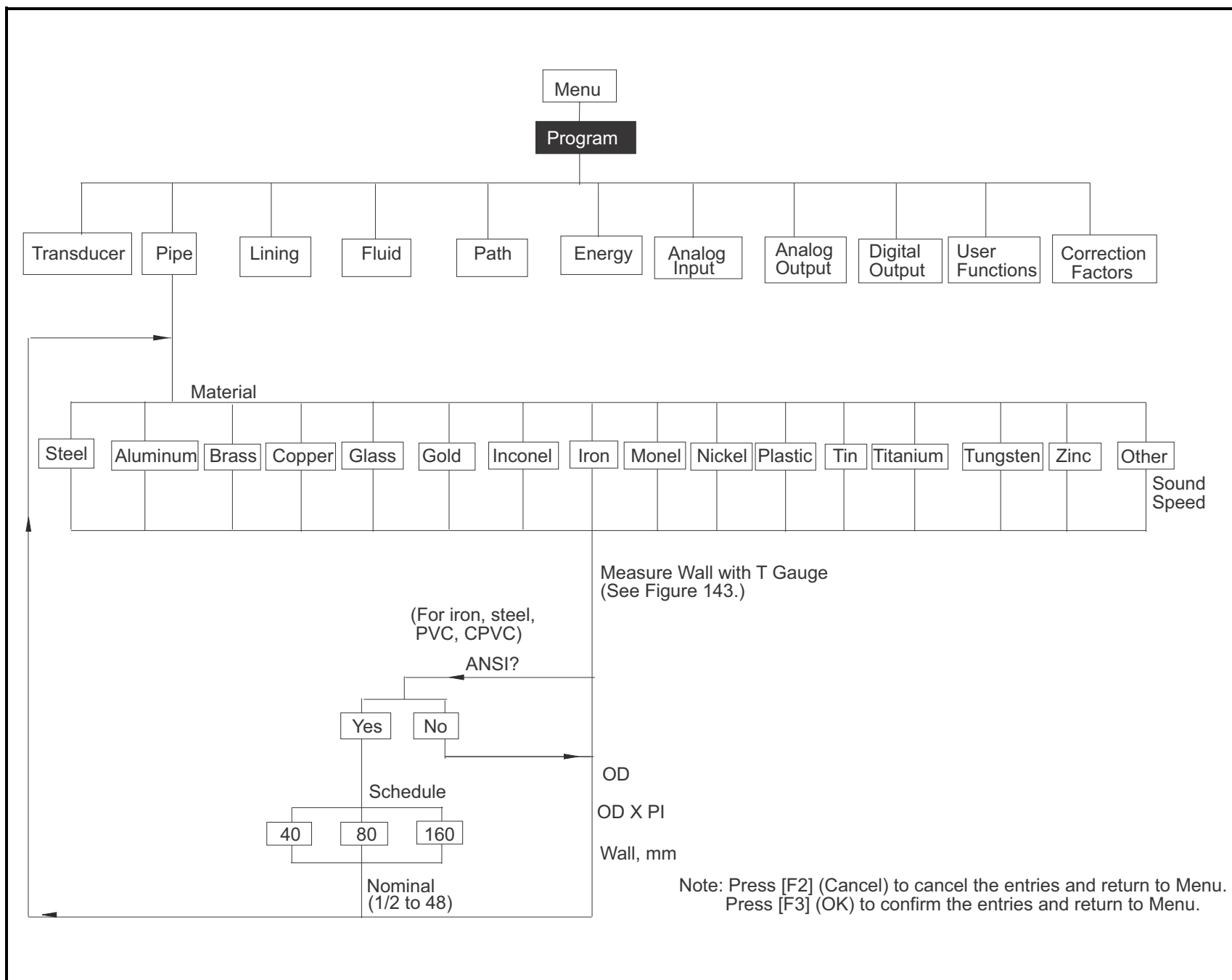

Figure 139: Program Menu with Pipe Option

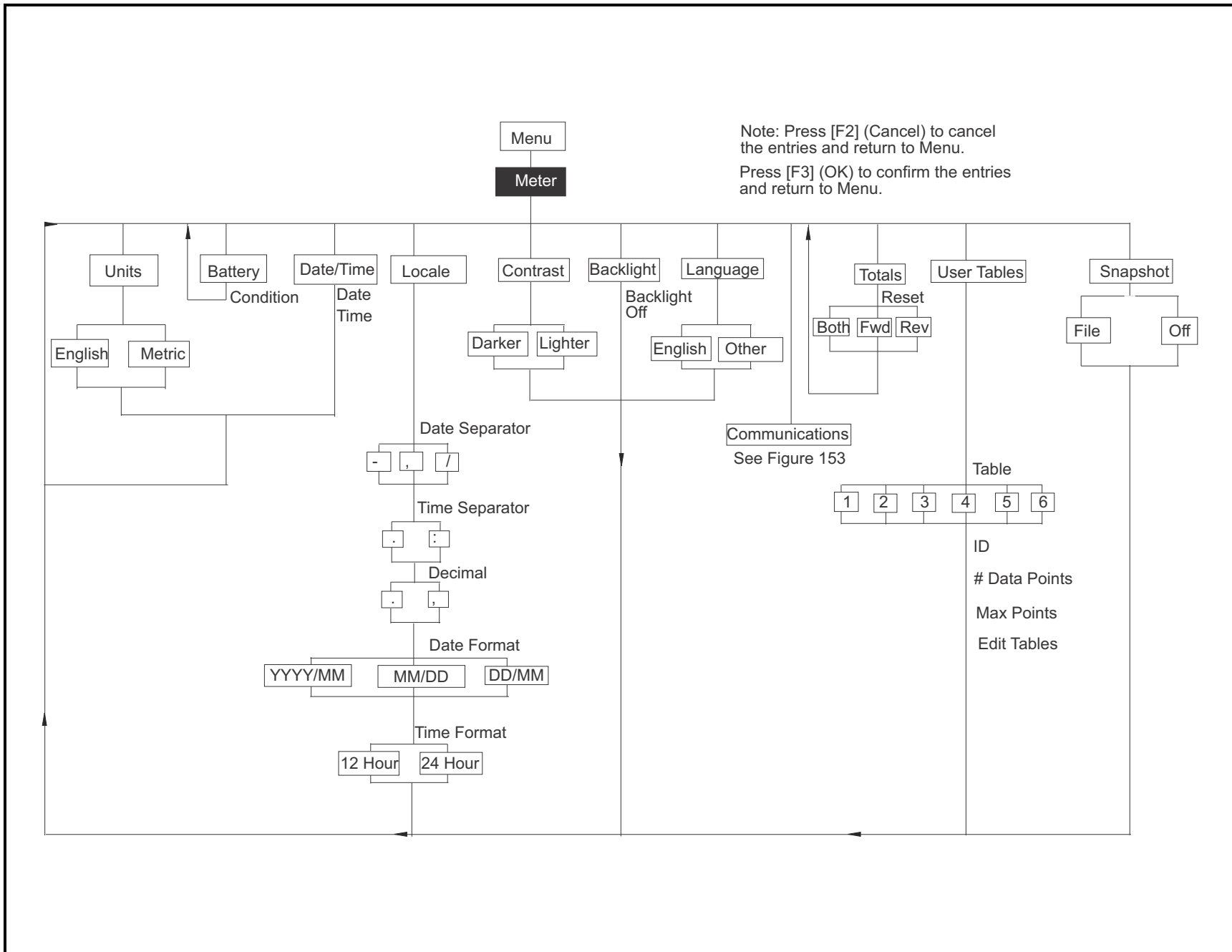

Figure 140: Meter Menu

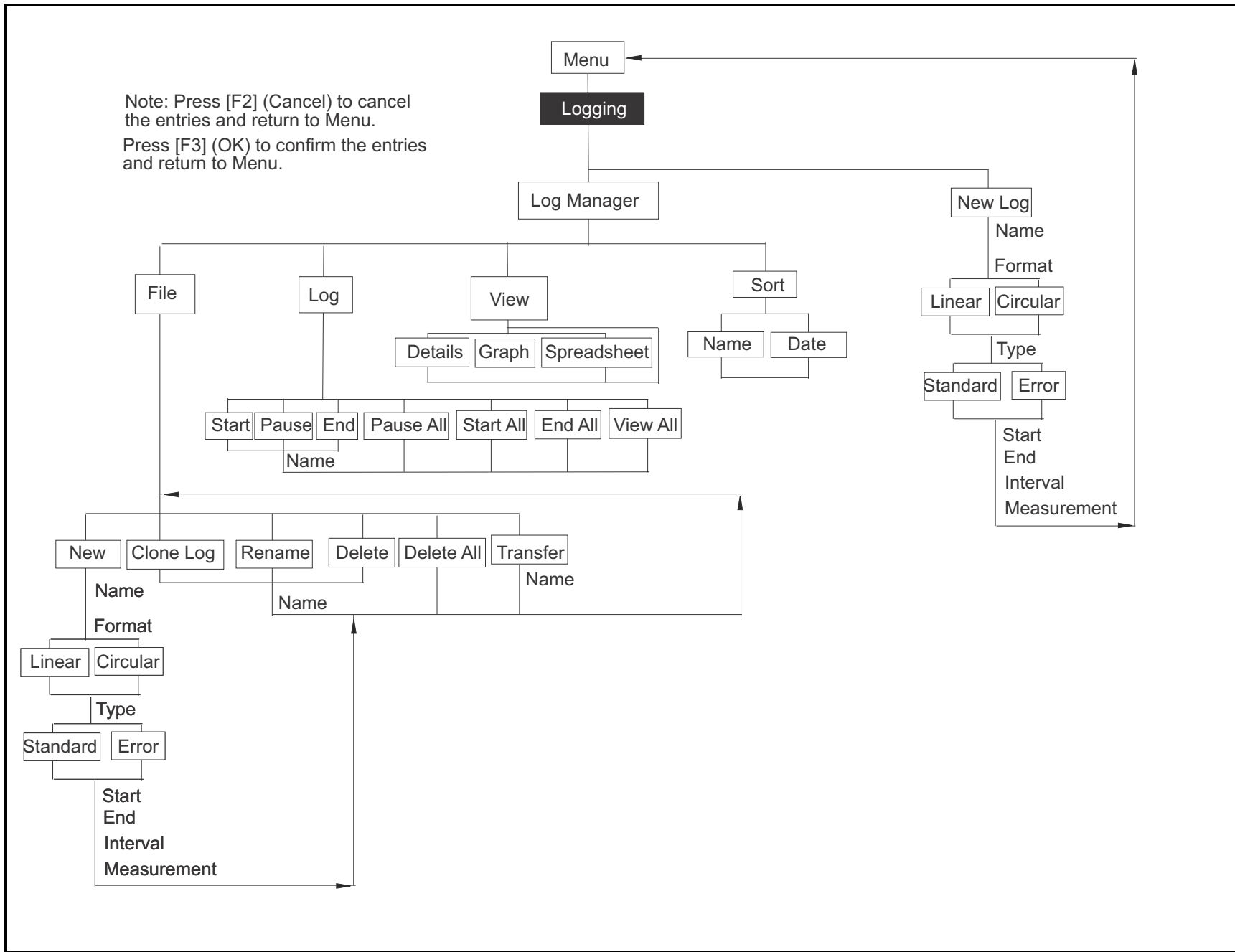

Figure 141: Logging Menu

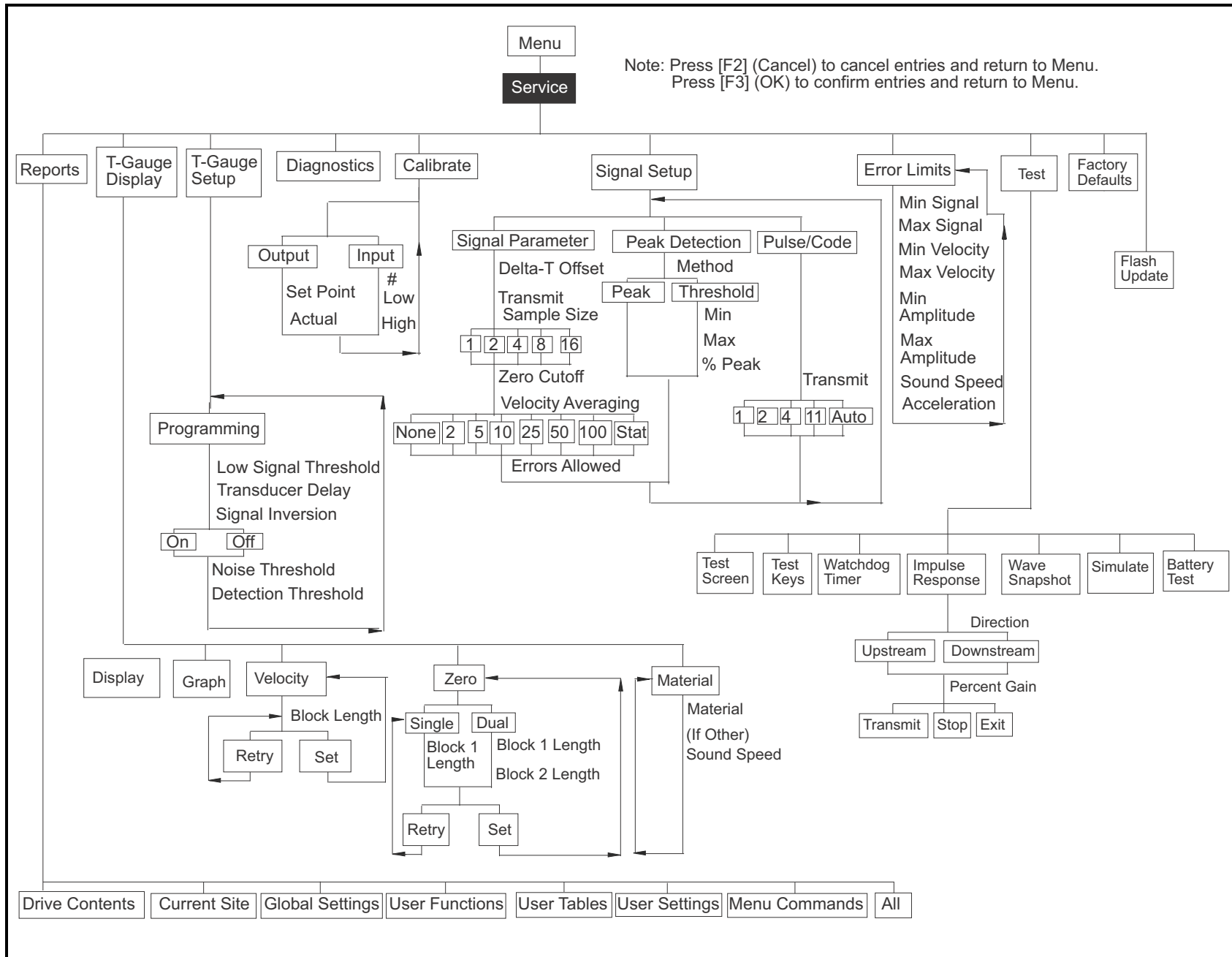

Figure 142: Service Menu

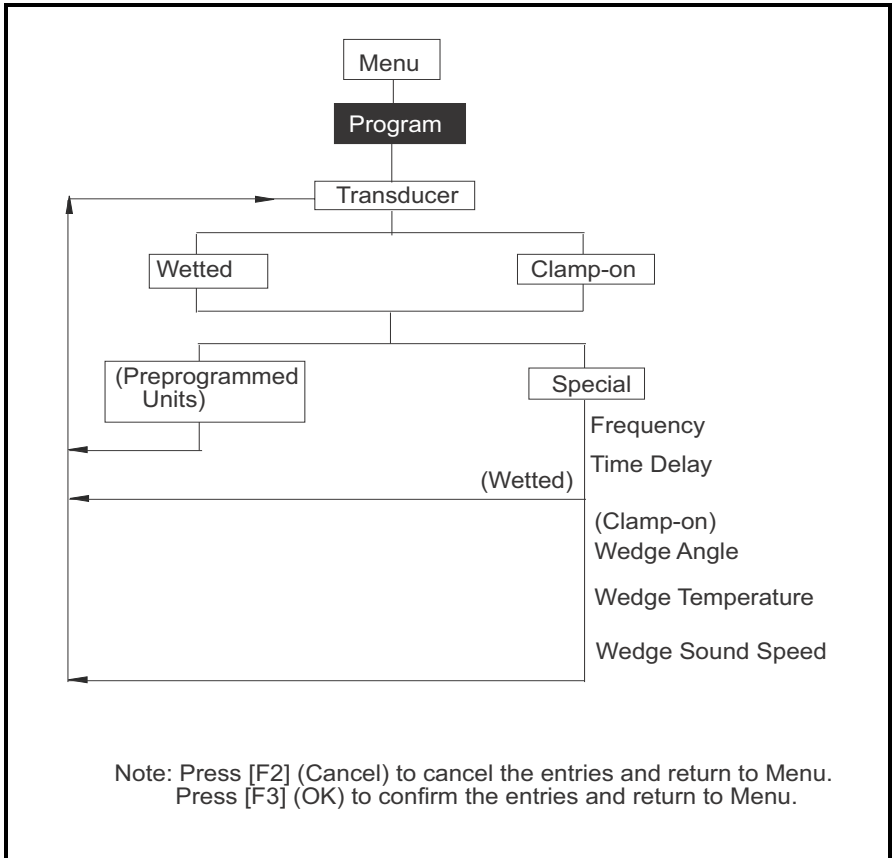

Figure 143: Transducer Option

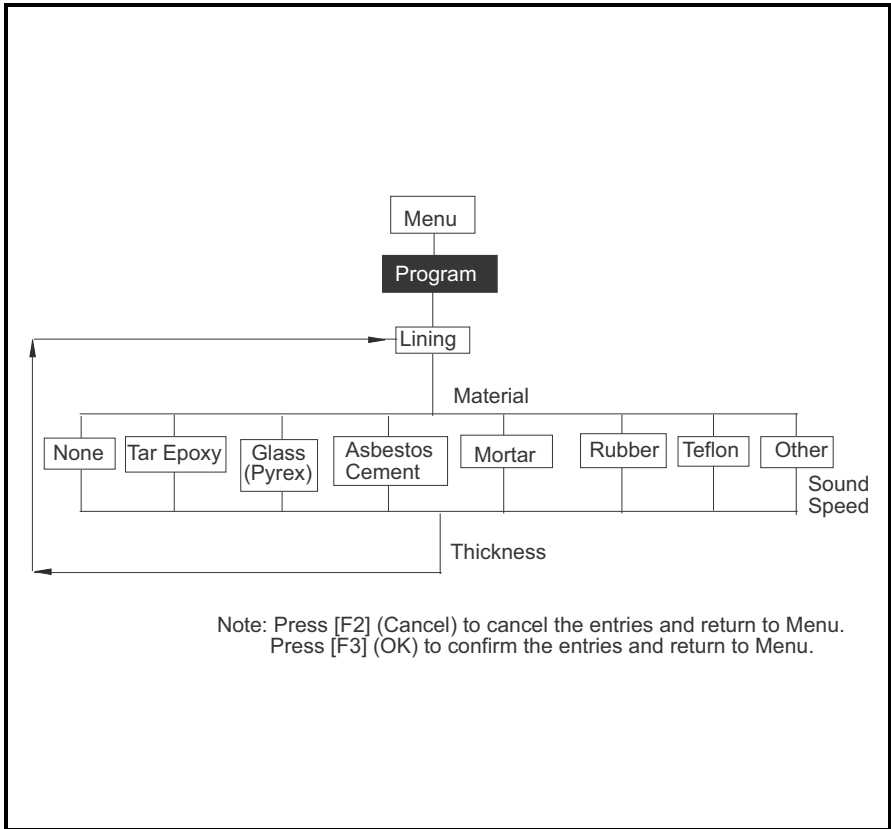

Figure 144: Lining Option

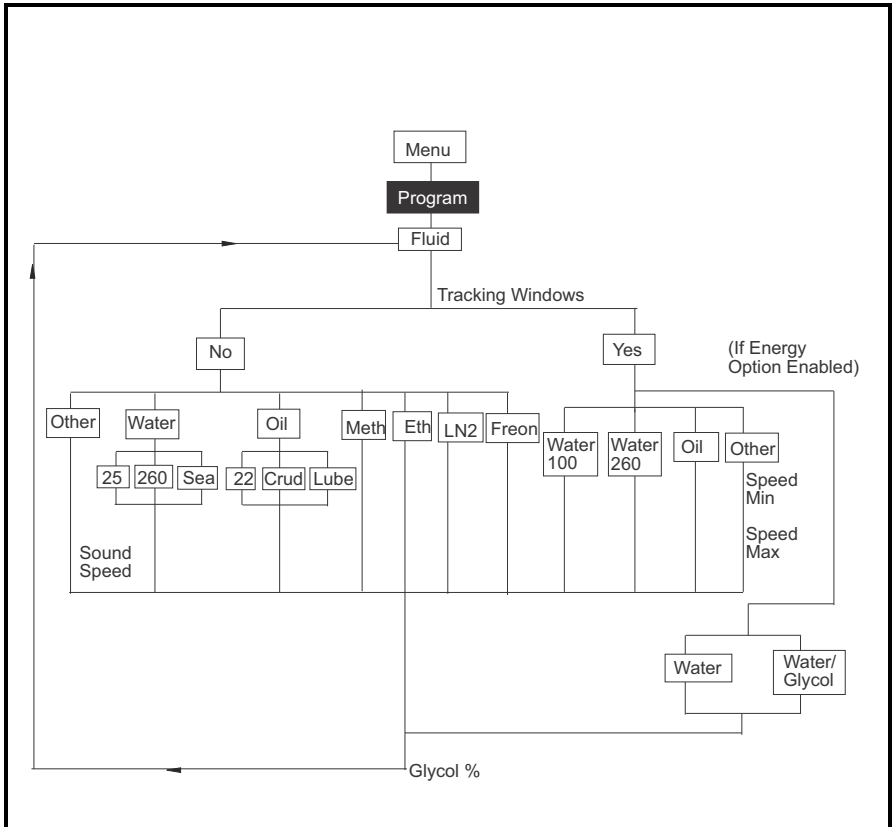

Figure 145: Fluid Option

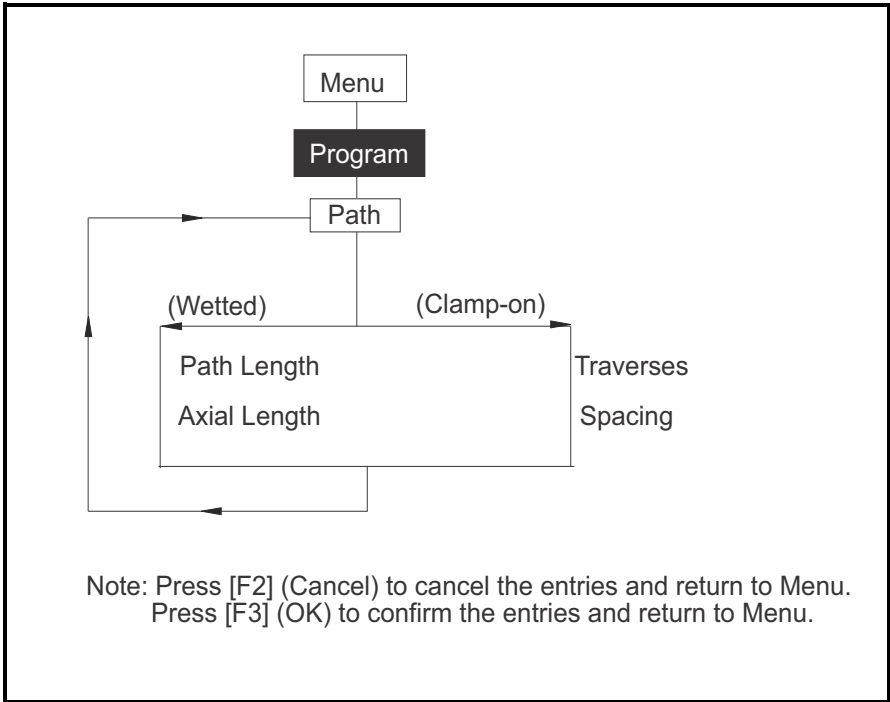

Figure 146: Path Option

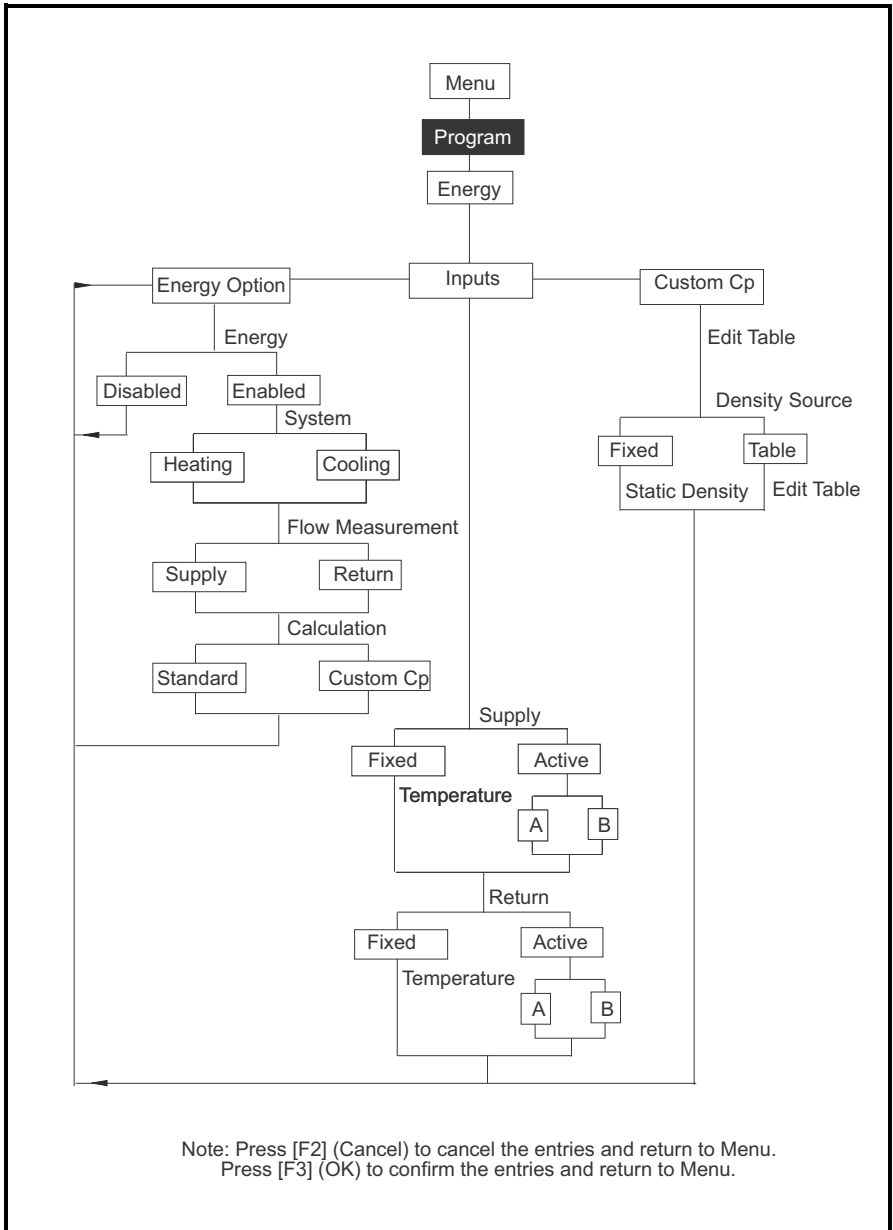

Figure 147: Energy Option

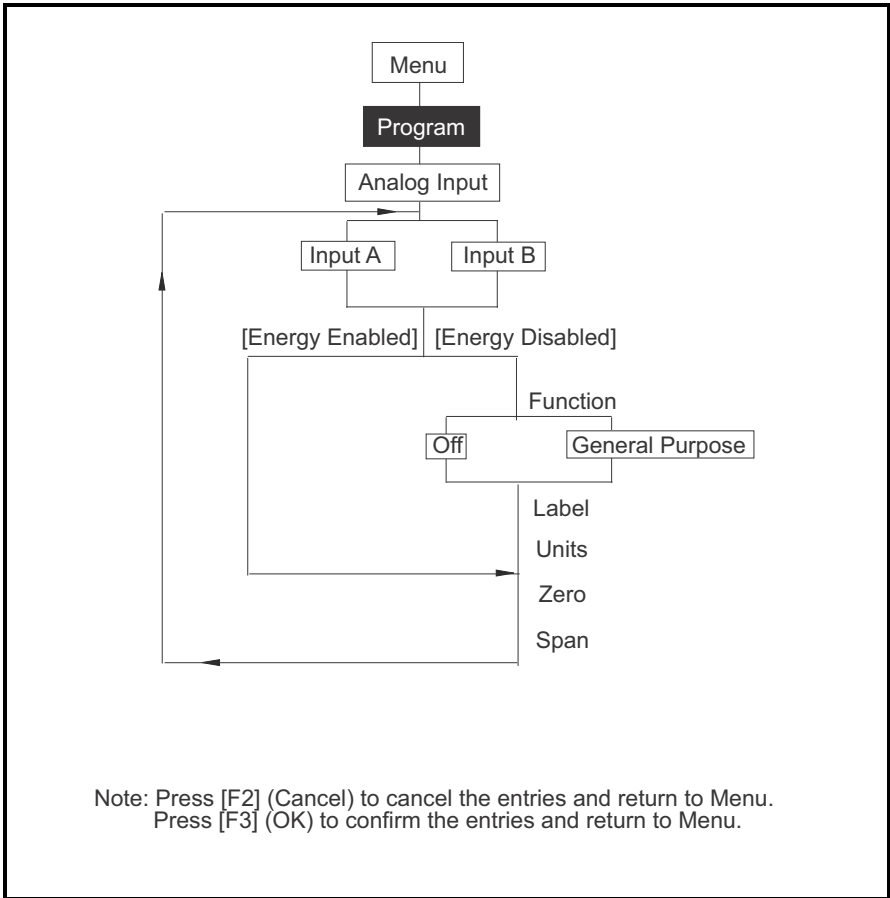
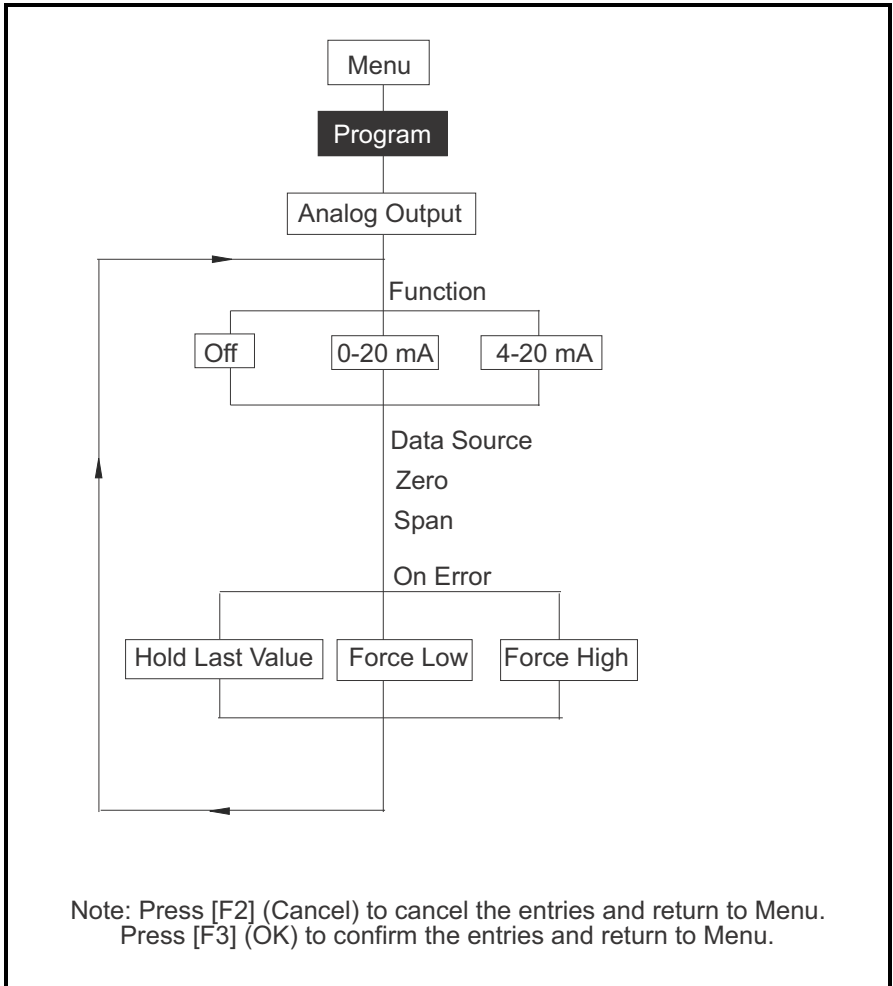

Figure 148: Analog Input Option

**Figure 149: Analog Output Option**

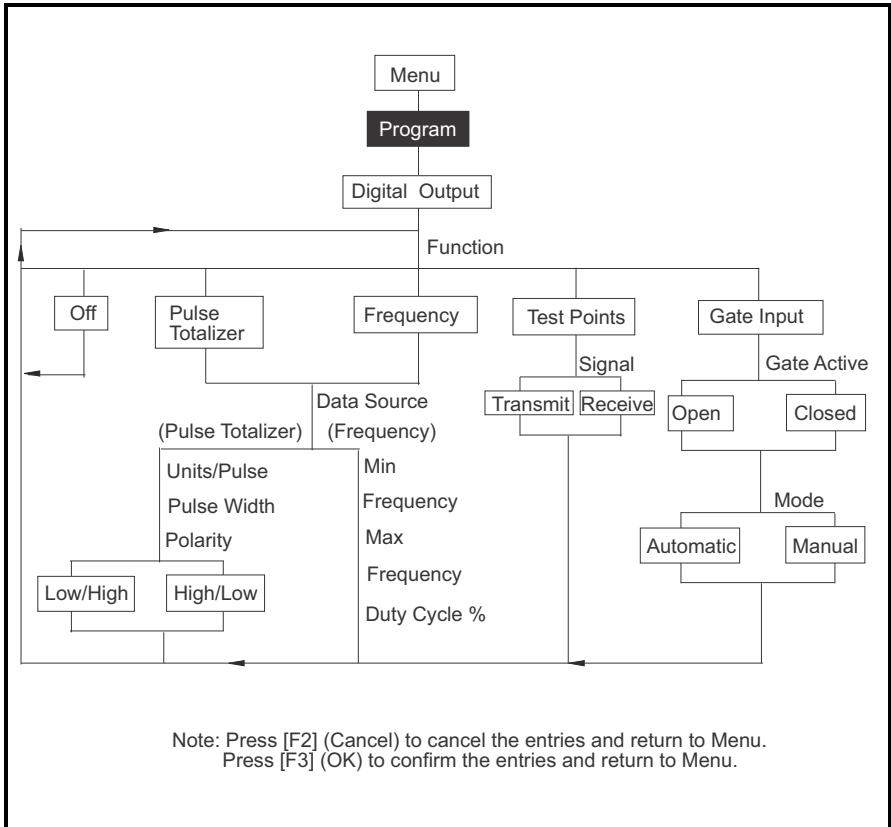
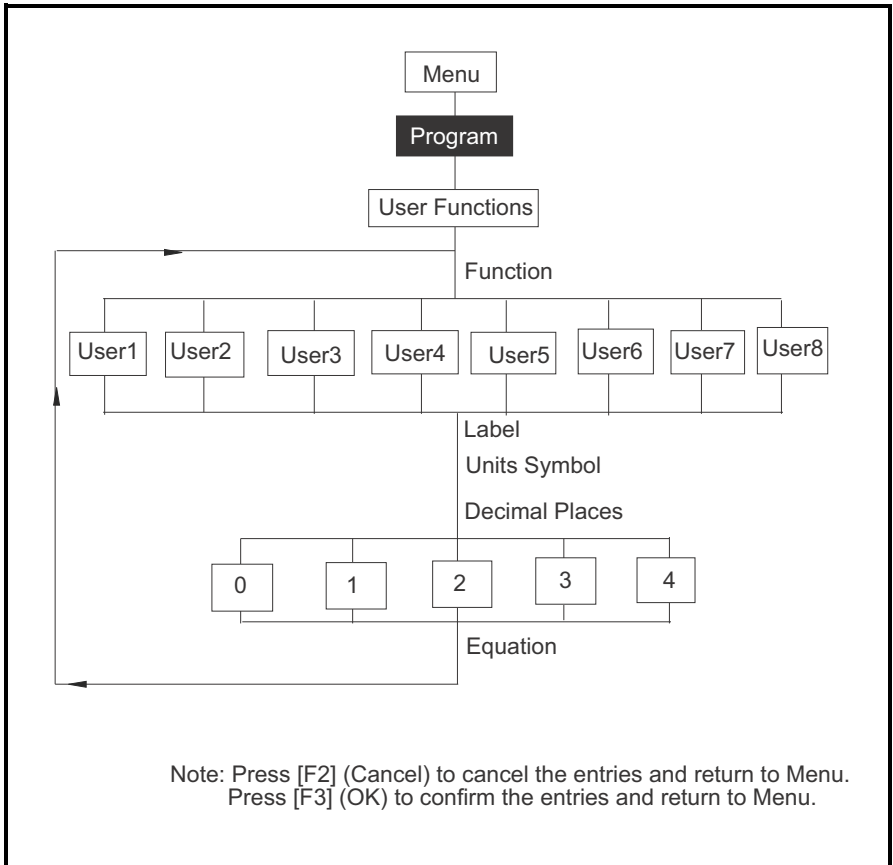

Figure 150: Digital Output Option

**Figure 151: User Functions Option**

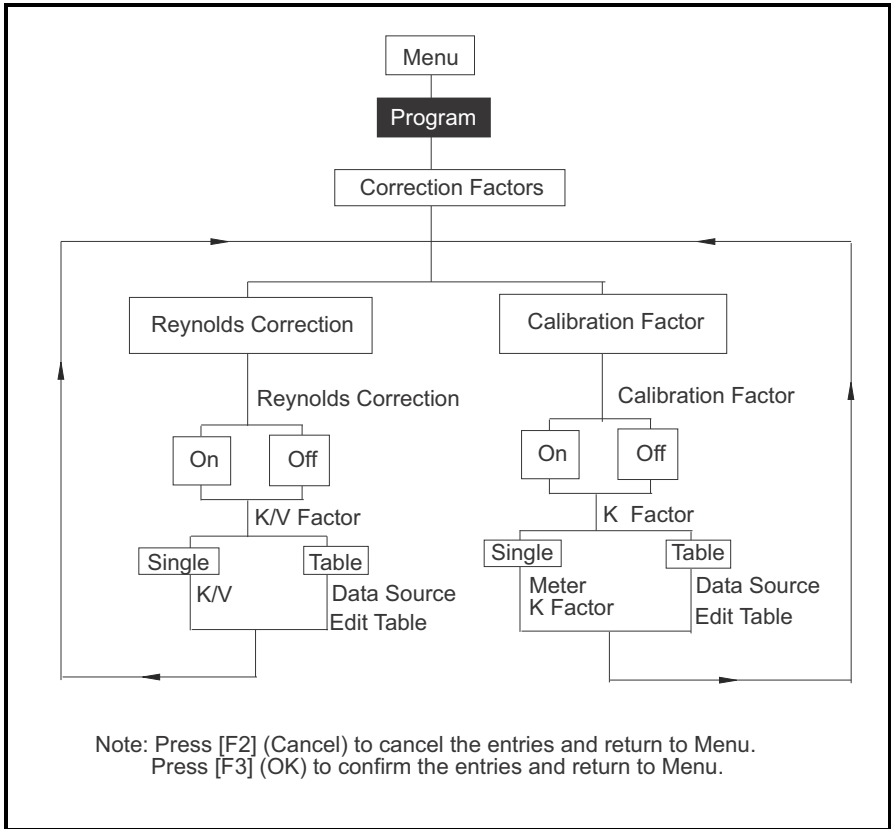

Figure 152: Correction Factors Option

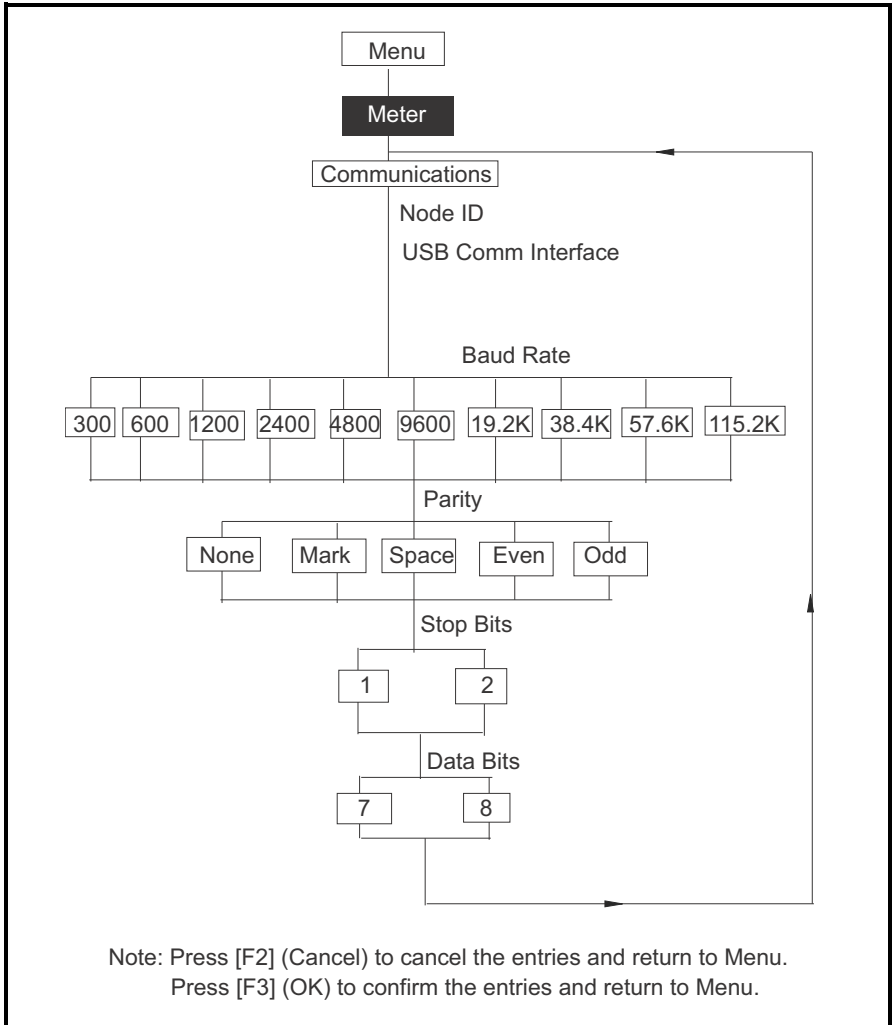

Figure 153: Communications Option

[no content intended for this page - proceed to next page]

Appendix B.Measuring P and L Dimensions

If you are using wetted transducers, the PT878 requires you to enter the path length (P) and the axial dimension (L). P is the transducer face-to-face distance, and L is the axial projection of P in the flow stream.

To determine L, physically measure the distance between the center of the transducer ports at the inside wall as shown in Figure 154 below, if possible. If not, consult the factory.

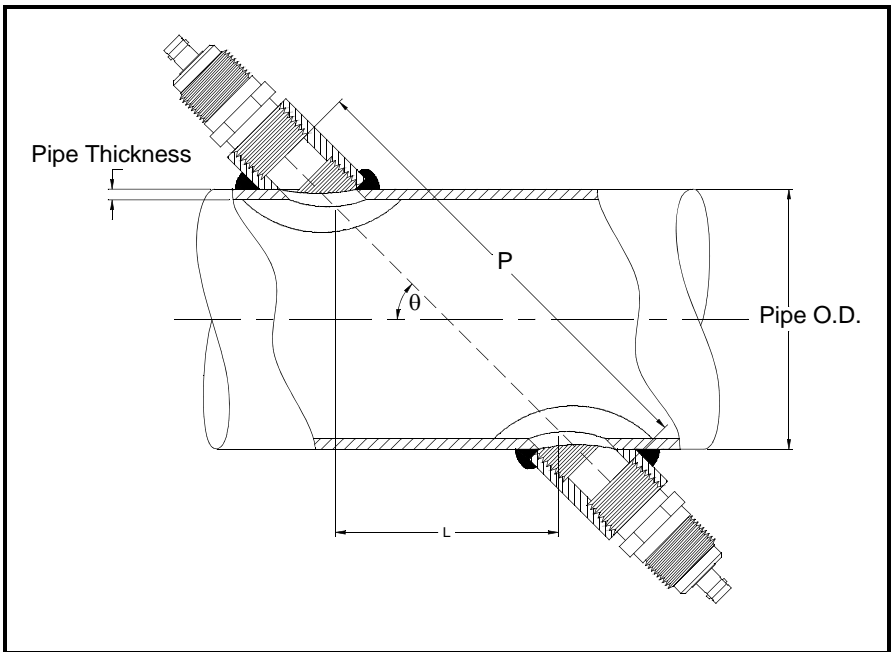

Figure 154: Top View of 180° Transducer Installation

To determine P, you need the following:

- the pipe inside diameter (ID)
- the wall thickness (WT)
- the installed pipe coupling length (CL)
- the transducers face depth (FD)
- the mounting angle (MA)

Use Figure 155 below to properly measure the coupling length. Typically, the transducer face is positioned just outside the inside diameter (ID) of the pipe, or slightly retracted inside the coupling.

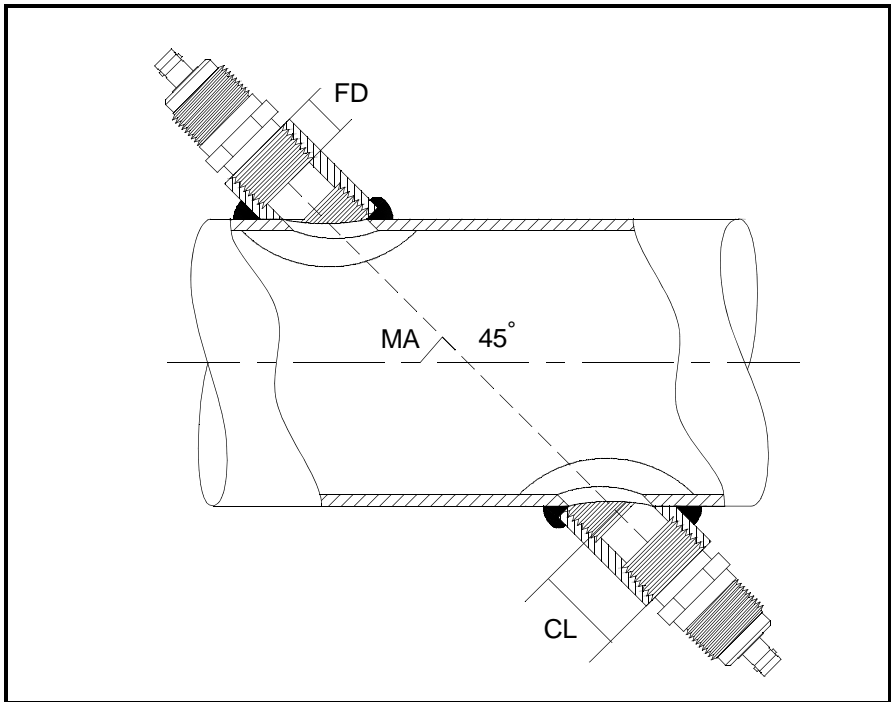

Figure 155: Determining the Pipe Coupling Length

Use the following formula to determine the P dimension:

$$[ID + 2(WT)]/(\cos MA) = 2 (CL - FD) = P \text{ dimension}$$

For example, given the following:

- inside diameter (ID) = 48"
- wall thickness (WT) = 3/8"
- installed coupling length (CL) = 2.0"
- a transducer face depth (FD) = 1.75"
- mounting angle (MA) = 45°

The P dimension would be:

$$[48 + 2(3/8)]/(0.7071) + 2(2.0 - 1.75) = 69.4"$$

[no content intended for this page - proceed to next page]

Appendix C. Temperature Transmitter Installation

The PT878 requires a supply and return temperature input to measure energy rate and consumption. You must connect the temperature sensors to a 4 to 20 mA transmitter (powered by the PT878 or externally) and then from the transmitter to the PT878 (a special GE cable is required to make transmitter-to-PT878 connections).

The factory can supply the Resistive Temperature Device (RTD) and a Dual Transmitter (DTR) or you may supply your own. If you supply your own equipment, you will need to order a special GE cable with a LEMO connector to make connections from the transmitter to the PT878.

To install the RTDs, you need to do the following:

- find a suitable installation site
- mount RTDs on the pipe
- make electrical connections

Use the instructions that follow to install the RTDs.

C.1 Guidelines for RTD Installation

You should have discussed possible installation sites with an applications engineer or field sales person by the time you receive the RTDs. However, you should follow these guidelines to ensure accurate temperature measurement:

- Do not install the RTD on a pipe seam.
- Clean the pipe at the installation location.
- Do not install the RTD on the top or the bottom of the pipe.
- Apply thermal couplant to the RTD before mounting it to the pipe.
- Insulate the pipe and RTD after installation.

If you have a GE RTD, use the instructions in the next section to properly mount the RTD on the pipe.

C.2 Mounting RTDs on the Pipe

The factory supplies a clamping fixture to mount the RTDs to the pipe; however, you must assemble the clamping fixture before you can mount the RTDs to the pipe. Use the following instructions below to mount the RTDs.

C.2.1 Assembling the Clamping Fixture

The clamping fixture consists of the following parts:

- one strap (length depends on the pipe size)
- a screw buckle
- a feeder buckle

To assemble the clamping fixture:

1. Cut the strap equal to the circumference of the pipe.
2. Fold 1/2 inch of one end of the strap into a hook shape.
3. Secure the screw buckle to one end of the strap by placing the strap through the buckle and folding the strap.
4. Crimp the strap closed to secure the screw buckle in place.
5. Each RTD has a securing post (located on the rounded portion of the RTD) that secures the RTD in place when it is mounted on the pipe. Place the RTD on the strap by sliding the strap under the securing post.

Important: *Make sure you place the RTD on the strap so when the strap is wrapped around the pipe, the flat surface of the RTD sits against the pipe.*

6. Secure the feeder buckle to the other end of the strap by placing the strap through the buckle and folding the strap (the folded section should be approximately 1/2 inch).
7. Crimp the strap closed to secure the feeder buckle in place.

Repeat steps 1 through 7 for the remaining RTD and clamping fixture. When you have completed assembly, proceed to the next section to fasten the RTD to the pipe.

C.2.2 Mounting the RTD to the Pipe

Use the steps below to fasten the RTD to the pipe:

1. Prepare the pipe where you intend to place the RTD. The area should be clean and free of loose material.
2. Apply couplant (GE part number 401-001) to the copper face of the RTD. Use enough couplant to cover the face of the RTD, but not so much that the couplant oozes out from underneath.
3. Position the RTD on the pipe and wrap the clamping fixture around the pipe.
4. To secure the RTD, you place the feeder buckle into the screw buckle and use a screwdriver to tighten. Turn the screw clockwise until the strap is set securely against the RTD.

Proceed to the following section to make electrical connections.

C.3 Making Electrical Connections

The PT878 will not accept a signal directly from the RTD; therefore, you must have some type of 4 to 20-mA transmitter. The factory supplies a dual transmitter (DTR) with a special LEMO connector that attaches to the PT878. The PT878 supplies power to the DTR using an internal 16 V supply. If you decide to supply your own transmitter, you can use the 16 V supply to power your transmitter; however, you will need to order the special LEMO connector cable to connect your transmitter to the PT878.

To make electrical connections, you must connect the RTD sensor to the 4 to 20-mA transmitter, and then connect the DTR to the PT878. Use the following sections to make electrical connections.

C.3.1 Connecting the RTD to the 4 to 20-mA Transmitter

RTDs should have two common leads and one signal lead. If you are using a GE RTD, the wire colors may vary; however, two of the RTD wires will be the same color. The wires that are the same color are the common leads and the remaining wire is the signal lead.

If you are using your own transmitter, make the necessary connections. If you are using the GE DTR, connect the RTD wires to the terminal block labeled RTD Inputs. Connect the common and signal wires to the appropriate pins as designated on the terminal block label.

Important: *The supply and return RTD cables must be the same length in order to make accurate temperature measurements.*

When you have completed supply and return connections, proceed to the next section.

C.3.2 Connecting the Transmitter to the PT878

If you are using the GE DTR, simply plug the LEMO connector into the I/O connector as shown in Figure 156 below.

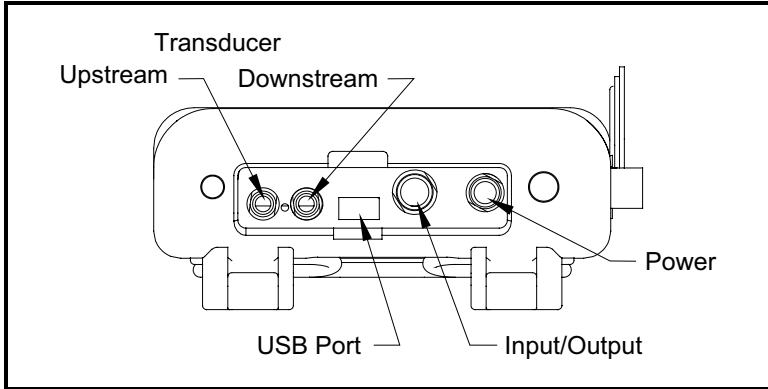

Figure 156: Connection Locations

Note: For input/output cable connections see Table 1 on page 8.

If you are using your own transmitter, you must connect the special GE cable to your transmitter as shown in Table 9 below.

Table 9: Cable Connections from GE Cable to Customer-Supplied Transmitter

Pin Number GE Cable	Wire Color GE Cable	Description
2	Red	16 V (unpowered transmitters only)
3	White	Supply Temperature
4	Yellow	Return Temperature
5	Green	Ground (for both supply and return)

Once you complete making the above connection, plug the LEMO connector into the I/O connector as shown in Figure 156 above. You have completed RTD installation.

[no content intended for this page - proceed to next page]

Appendix D. Ultrasonic Thickness Gauge Theory of Operation

All ultrasonic thickness gauging involves timing the round trip of a sound pulse in a test material. Because solid metal has an acoustic impedance that differs from that of gasses, liquids, or corrosion products such as scale or rust, the sound pulse will reflect from the far surface of the remaining metal. The test instrument is programmed with the velocity of sound in the test material, and computes the wall thickness from the simple formula

$$\text{Distance} = \text{Velocity} \times \text{Time}$$

Single element transducers use one element as both transmitter and receiver. Dual element transducers incorporate separate transmitting and receiving elements. These elements are mounted on delay lines that are usually cut at an angle to the horizontal plane (the roof angle), so that the transmitting and receiving beam paths cross beneath the surface of the test piece. This crossed-beam design of duals provides a pseudo-focussing effect that optimizes measurement of minimum wall thickness in corrosion applications. Duals will be more sensitive than single element transducers to echoes from the base of pits that represent minimum remaining wall thickness. Also, duals may often be used more effectively on rough outside surfaces. Couplant trapped in pockets on rough sound entry surfaces can produce long, ringing interface echoes that interfere with the near surface resolution of single element transducers. With a dual, the receiver element is unlikely to pick up this false echo. Finally, duals may be designed for high temperature measurements that would damage single element contact transducers.

D.1 Factors Affecting Performance and Accuracy

A. Surface Condition - Loose or flaking scale, rust, corrosion or dirt on the outside surface of a test piece will interfere with the coupling of sound energy from the transducer into the test material. Thus, any loose debris of this sort should be cleaned from the specimen with a wire brush or file before measurements are attempted. Generally it is possible to make corrosion measurements through thin layers of rust, as long as the rust is smooth and well bonded to the metal below. Some very rough cast or corroded surfaces may have to be filed or sanded smooth in order to insure proper sound coupling. It may also be necessary to remove paint if it has been applied in thick coats, or if it is flaking off the metal. While it is often possible to make corrosion measurements through thin coats of paint (on the order of a few thousandths of an inch or 0.1 - 0.2 mm), thick paint will attenuate signals or possibly create false echoes, causing inaccurate measurements.

Severe pitting on the outside surface of a pipe or tank can be a problem. On some rough surfaces, the use of a gel or grease rather than a liquid couplant will help transmit sound energy into the test piece. In extreme cases it will be necessary to file or grind the surface sufficiently flat to permit contact with the face of the transducer. In applications where deep pitting occurs on the outside of a pipe or tank it is usually necessary to measure remaining metal thickness from the base of the pits to the inside wall. There are sophisticated ultrasonic techniques utilizing focussed immersion transducers that can measure directly from the base of the pit to the inside wall, but this is generally not practical for field work. The conventional technique is to measure unpitted metal thickness ultrasonically, measure pit depth mechanically, and subtract the pit depth from the measured wall thickness. Alternately, one can file or grind the surface down to the base of the pits and measure normally.

As with any difficult application, experimentation with actual product samples is the best way to determine the limits of a particular gauge/transducer combination on a given surface.

D.1.1 Transducer Positioning/Alignment

For proper sound coupling the transducer must be pressed firmly against the test surface. On small diameter cylindrical surfaces such as pipes, hold the transducer so that the sound barrier material visible on the probe face is aligned perpendicular to the center axis of the pipe. See Figure 157 below.

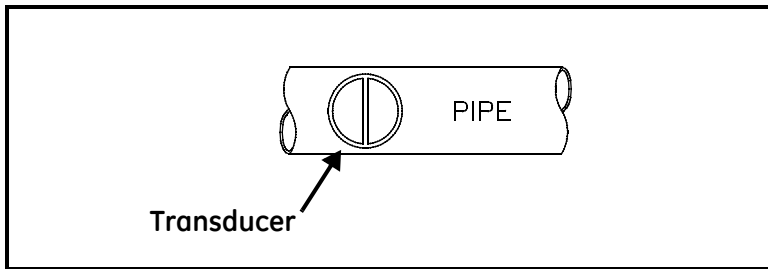

Figure 157: Proper Alignment of Transducers for Cylindrical Surfaces

While firm hand pressure on the transducer is necessary for good readings, the probe should never be scraped along or twisted against a rough metal surface. This will scratch the face of the transducer and eventually degrade performance. The safest technique for moving a transducer along a rough surface is to pick it up (not slide it) and reposition it for each measurement.

Remember that an ultrasonic test measures thickness at only one point within the beam of the transducer. In corrosion situations, wall thicknesses often vary considerably. Test procedures usually call for making a number of measurements within a defined area and establishing a minimum and/or average thickness. Ideally, data should be taken at increments no greater than half the diameter of the transducer, to insure that no pits or other local variations in wall thickness are missed. It is up to the user to define a pattern of data collection appropriate to the needs of a given application.

It is possible that on some severely corroded or pitted materials there will be spots where readings cannot be obtained. This can happen when the inside surface of the material is so irregular that the sound energy is scattered rather than being reflected back to the transducer. The lack of a reading may also indicate a thickness outside the range of the transducer and instrument being used. Generally, an inability to obtain a valid thickness reading at a particular point on a test specimen could be a sign of a seriously degraded wall which may warrant investigation by other means.

D.1.2 Calibration

The accuracy of measurements are only as good as the accuracy and care with which the gauge has been calibrated. It is essential that the thickness gauge be calibrated (as shown on page 162) whenever the transducer is changed or you have a reason to doubt the accuracy of the readings. Periodic checks with samples of known thicknesses are recommended to verify that the gauge is operating properly.

D.1.3 Taper or Eccentricity

If the contact surface and the back surface are tapered or eccentric with respect to each other, the return echo again becomes distorted and the accuracy of measurement is diminished.

D.1.4 Acoustic Properties of the Material

There are several conditions found in engineering materials that can severely limit the accuracy and thickness range that can be measured.

D.1.4a Sound Scattering

In some materials, notably certain types of cast stainless steel, cast irons, and composites, the sound energy is scattered from individual crystallites in the casting or from dissimilar materials within the composite. This effect reduces the ability to discriminate a valid return echo from the back side of the material and limits the ability to gauge the material ultrasonically.

D.1.4b Velocity Variations

A number of materials exhibit significant variations in sound velocity from point-to-point within the material. Certain types of cast stainless steels and brass exhibit this effect due to a relatively large grain size and the anisotropy of sound velocity with respect to grain orientation. Other materials show a rapid change in sound velocity with temperature. This is characteristic of plastic materials where temperature must be controlled in order to obtain maximum precision in the measurement.

D.1.4c Sound Attenuation or Absorption

In many organic materials, such as low density plastics and rubber, sound is attenuated very rapidly at the frequencies used in normal ultrasonic thickness gaging. Therefore, the maximum thickness that can be measured in these materials is often limited by sound attenuation.

[no content intended for this page - proceed to next page]

Appendix E. Material Safety Data Sheet for Couplant

(To comply with 29 CFR 1910.1200) Effective Date 4/1/98

Note: *N/A = not applicable or not available*

E.1 Product Identification

Product Name: **SOUNDSAFE®**

Generic Name: Ultrasonic Couplant

Manufacturer: Sonotech, Inc.

774 Marine Dr., Bellingham, WA 98225

360-671-9121

FAX: 360-671-9024

E-mail: sonotech@nas.com

<http://www.sonotech-inc.com>

NFPA Hazardous Materials Identification System (est)

Health 0

Flammability.....0

Reactivity.....0

E.2 Hazardous Ingredients

This material does not contain any ingredients having known health hazards in concentrations greater than 1%.

This material does not contain any known or suspected carcinogens.

E.3 Physical Data (nominal)

Boiling Point: >220°F

Freezing Point: <20°F

Vapor Pressure: N/A

Evaporation Rate: N/A

Solubility in Water: complete

Appearance and Odor: water white, opaque gel; bland odor

pH: 7.35 - 7.9

Acoustic Imp.: 1.726×10^6

Vapor Density: N/A

Specific Gravity: 1.05

E.4 Fire and Explosion Hazard Data

Flash Point: none

Upper Exposure Limit: none

Lower Exposure Limit: none

Special Fire Fighting Procedures: N/A

Extinguishing media: N/A

Unusual Fire and Explosion Hazards: none

E.5 Reactivity Data

Stability: stable

Conditions to Avoid: none

Incompatibility (*Materials to Avoid*): none known

Hazardous Polymerization: will not occur

Hazardous decomposition or Byproducts: none known

E.6 Health Hazard and First Aid Data

Routes of Entry: ¹

Skin: not likely

Eyes: not normally

Ingestion: not normally

Inhalation: no

¹**SOUNDSAFE®** contains only food grade and cosmetic grade ingredients.

Effects of Overexposure:

Acute: May cause temporary eye irritation.

Chronic: None expected.

First Aid Procedures:

Skin: Remove with water if desired.

Eyes: Flush with water for 15 minutes.

Ingestion: For large quantities, induce vomiting and call a physician.

Inhalation: N/A

E.7 Storage and Handling Information

Precaution to be taken in handling and storage:

Store between 20°F and 120°F. Spills are slippery and should be cleaned up immediately.

Steps to be taken in case material is released or spilled: Pick up excess for disposal. Clean with water.

Waste disposal method: Dispose of in accordance with federal, state, and local regulations.

E.8 Control Measures

Respiratory Protection: not required

Ventilation: not required

Protective Gloves: on individuals demonstrating sensitivity to
SOUNDSAFE®

Eye Protection: as required by working conditions

Other Protective Equipment: not required

Appendix F. Glossary

AGC — Automatic gain control, which sets the receive amplifier based on measured signal strength. This electronic circuit automatically adjusts the gain of the receive amplifier to maintain the correct receive signal amplitude.

Calibration Factor — Correction factor used as a reference for the flowmeter electronics to ensure accurate readings, and available either as a single number or as a table.

Delta-T Offset — A programmed value of which half is added to the upstream transit time and half is subtracted from the downstream transit time. It can be used to offset the flow velocity reading, and is normally set to zero.

Detection Threshold — Percent of peak the PT878 thickness gauge uses to make measurements

Energy Option — Option that enables flow measurement in a heating or cooling system. The option calculates the energy of a system based on the temperature at a supply point, the temperature at a return point, and the flow of fluid through the system.

Errors Allowed — Parameter that specifies the number of errors the meter can record before displaying an error message. The number of errors is N out of 16 where N equals the number of errors allowed.

Flowcell — The part of the flowmeter system, consisting of the flowcell pipe and the transducers, that uses ultrasonic pulses to interrogate the flow.

Flowcell Pipe — A section of piping that acts as part of the flowcell; it is either a section of existing piping with the transducers or inserted as a substitute pipe section (spoolpiece).

Form — Software window that opens when a user enters a given menu.

Impulse Response — Option in the Service Menu that enables you to force the meter to transmit in one direction only, without changing the amplifier gain setting.

Locale — Format for displaying the time and date.

Peak Detection — A method for identifying the ultrasonic signature in the received signal. In the “Peak” method, the peak is identified by testing a derivative of the signal. In the “Threshold” method, the peak is identified as the point where the signal crosses a threshold that is a percentage of the maximum signal detected.

Receive Window — A window of time during which the PT878 tries to detect the ultrasonic signal. It is determined by using the fluid soundspeed and the signal path length to estimate when the signal will arrive at the receiving transducer.

Reynolds Correction — Correction factor based on the Kinematic Viscosity and flow rate of the fluid.

Signal Inversion — Option that enables a thickness gauge user to invert the transducer signal.

Signal Path — Path the ultrasonic signal travels from one transducer to the other.

Simulate — Option in the Service Menu that allows users to simulate measurements based on a waveform stored in the PT878.

Site — A location on a pipe where measurements are made. The site includes the transducers, pipe, fluid type, pipe material and other parameters.

Site File — Instrument program that combines all the necessary parameters (transducer, pipe, fluid, etc.) for a particular measurement location.

Snapshot — Option in the Meter Menu to take screen captures in bitmap format of a given screen display.

Soundspeed — Speed at which a sound wave travels through a given material.

Thickness Gauge — Option that allows the PT878, with an optional thickness gauge transducer, to determine the thickness of most standard metal and plastic pipe materials over a range from 0.05 to 3 in. (1.3 to 76.2 mm).

Tw (time in wedge) — Time the transducer signal spends travelling through the transducer and cable. This time has to be subtracted from the transit time to determine how much time the signal spent in the fluid.

Tracking Windows — A feature which allows the receive window to move automatically if the ultrasonic signal is lost. The PT878 will set up the window in various positions based on a minimum and maximum soundspeed range. In seek mode, the meter will test every position until it detects a receive signal that passes the error tests. The first window (highest soundspeed setting) that passes the tests is the detected window. The meter will then track the receive signal.

Transducer Delay — Time the ultrasonic signal takes to travel from the meter to the pipe material surface. It is a similar measurement to Tw, except that the delay is subtracted from the transit time to find out how much time is spent in the wall.

Transducers — Devices that convert electrical energy into ultrasonic pulses when in a transmit cycle, and convert the ultrasonic pulses back to electrical energy when in a receive cycle. They can be fixed to the outside of the flowcell pipe (clamp-on) or inserted into the pipe to directly measure the fluid (wetted).

Transmitter Sample Size — Number of pulses the transmitter emits in one direction (upstream or downstream) before transmitting in the other direction. It is set to 8 by default.

Transit-Time — Flow measurement technique based on the principle that when ultrasonic pulses are transmitted through a moving liquid, the pulses that travel in the same direction as the fluid flow (downstream) travel slightly faster than the pulses that travel against the flow (upstream). When the liquid in the pipe is not flowing, the transit-time downstream equals the transit-time upstream. When the liquid is flowing, the transit-time downstream is less than the transit-time upstream. The difference between the downstream and upstream transit-times is proportional to the velocity of the flowing liquid, and its sign indicates the direction of flow.

Traverses — Number of times the ultrasonic signal crosses the pipe.

User Functions — User-defined mathematical equations for use with any measurement.

User Tables — User-defined tables of data for use with user functions.

Velocity Averaging — Parameter that averages a desired number of velocity measurements to smooth out or dampen noise in the system.

Watchdog Test — Option in the Service Menu that tests the watchdog timer circuit. If a software error causes the meter to stop responding, this circuit automatically resets the meter

Wave Snapshot — Option in the Service Menu that enables users to capture waveforms for downloading to a PC for analysis, or for simulating a flow measurement.

Wedge Angle — Angle of the transducer's ultrasonic transmission in the transducer wedge.

Zero Cutoff — Parameter that causes velocity measurements less than the absolute value of the cutoff (either positive or negative values) to be reported as zero.

A	
About Option	109
Acceleration Limit	188
Amplitude Discriminator Limits	188
Analog Inputs	
Calibration	177
Connections	7
Entering	50
in Energy Option	52, 53
Analog Outputs	
Calibration	177
Connections	7
Entering	54
Option	54
ANSI Schedule, Applying	34
Arrow Keys	20
Axial Length, Entering	41

B	
Backlight Option	121
Backlight, Timeout for	121
Bar Graph Display	92
Battery	
Charger	114, 115
Charging	12
Disposing of	14
Option	114
Replacing	13
Storing	12
Testing	198

C	
Calibration	
Analog Input	177
Analog Output	177
Calibration Factor, Entering	67
Capturing Signals	195
Checks, Power Up	15
Clamp-On Transducers, Path Parameters for	40
Clearing Softkey	101

Communications Option	123
Configuring the Display	89
Connections	6
Analog Inputs	7
Analog Outputs	7
Power	7
Transducers	7
Contrast Option	120
Contrast, Adjusting	120
Correction Factors Option	65
Correction Factors, Entering	65
Customizing Softkeys	99

D

Data Acquisition	3
Data Sources, Changing	95, 96
Date and Time Options	117
Date, Entering	115, 116
Date/Time Format, Changing	117
Defaults, Resetting to	199
Delta-T Offset	182, 259
Detection Threshold	175
Diagnostic Parameters, Displaying	176
Diagnostics	201, 204
Error Messages	202
Option	176
Digital Output Option	57
Display Options	117
Display Screen	18
Configuring	97
Displaying Data as Graph	92
Document Number	i
Drive Manager	102

E

Electrical Connections	6
----------------------------------	---

Electronics	
Description	3
Error Messages	202
Specifications	214
Theory of Operation	4
Energy Option	
Entering Inputs	44, 46, 47, 48
Entering Parameters	42
English Units	113
ENT Key	20
Environmental Compliance	v
Error Limits Option	187
Error Messages	202
Battery	12
Errors Allowed	183, 259
EXIT Key	20

F

Factory Defaults Option	199
Feature Keys	20
File	
Manager, Sort Menu	108
Menu, in Log Manager	134
Transferring from PC	105
Transferring to PC	104
Flowcell	2
Fluid	
Option	37
Problems, Flowcell	206
Speeds, Entering	37
Types, Entering	37
Format Option	90
Forward Total, Resetting	126
French Language Display	122
Frequency	59

G

Gate Input	60
Graph Display	92

H	
Help	22
I	
Impulse Response Option	194
Information Paragraphs	iii
Initial Setup	5
Input/Output	3
Connections	7, 8
Inputs	
Analog Inputs	7
Analog, Entering	50
in Energy Option	44, 46, 47, 48
K	
Keypad Description	20
Kinematic Viscosity, Entering	66
L	
Language Option	122
Language, Changing	122
Limits Option	93
Line Graph Display	92
Lining Parameters, Entering	35
Listing Files	
By Date	86, 108
By Name	86, 108
Listing Logs	
By Date	155
By Name	155
Locale Option	117

Log	
Copying	140
Creating	135
Deleting	141
Deleting All	142
Displaying Details	150
Ending	147
Ending All	148
In Graph Form	151, 152, 153
In Spreadsheet Format	154
Renaming	141
Restarting	147
Stopping	147
Stopping All	148
Transferring to PC	143
Log Manager	133
Log Menu	146
Sort Menu	155
Logging Menu Map	224
Logging Menu, Entering	132
Low Signal Threshold	174

M

Main Menu, Menu Map	219
Material in Thickness Gauge Setup Option	163
Measurement	
Option	95, 96
Parameters, Changing	95, 96
Units, Selecting	113
Messages	202
Meter Menu	
Entering	112
Menu Map	223
Meter Settings Window	113
Metric Units	113
Microcomputer	3
Model Number	109

N

Node ID for Communications	124
----------------------------	-----

Noise Threshold	175
Numeric Keys	20

O

On-Line Help	22
Output	
Analog, Entering	54
Digital, Entering	57
Outputs	
Analog Outputs	7

P

Parameters, Displayed	98
Path	
for Clamp-on	40
for Wetted Transducers	41
Length, Entering	41
Path Option	39
PC File Transfer	105
Peak Detection	184
Pipe	
Diameter, Entering	33
Lining, Entering	35
Material	31
Option Menu Map	222
Problems	207
Power Connections	7
Powering On/Off	15
Problems	
Flowcell	206
Fluid	206
Pipe	207
Transducers	208
Program Menu	21
Menu Map	222

PT878	
Features	1
Keypad	20
Powering On/Off	15
Screen	18
Software, Updating	200
Publication Date	i
Pulse Totalizer	58

R

Receiver	3
Refreshing a Site	79
Reports Option	161
Reports, Printing	161
Return Policy	276
Reverse Total, Resetting	126
Reynolds Correction, Entering	65

S

Safety	
Auxiliary Equipment	iv
General Issues	iii
Personal Equipment	iv
Sampling Waves	195
Schedule for Pipe Dimensions	33
Screen	
Description	18
On-Line Help	22
Service Menu	
Entering	158
Menu Map	225
Signal	
.	181
Capturing	195
Inversion	175, 260
Path, Entering	39
Setup Option	181

Site	
Creating a Message	81
Creating a New	74
Deleting	80, 107
Menu	71
Opening	76
Refreshing	79
Renaming	79
Saving	77
Saving with Different Name	78
Site Manager	72
Sort Menu	86
Softkey	
Clearing	101
Customizing	99
Software Version	109
Sort Menu	
in File Manager	108
in Log Manager	155
in Site Manager	86
Sound Speed Limits	188
Sound Speed, Calculating	171, 172
Span (Full Scale) Value for Analog Output	56
Special Transducers, Entering Data	26
Specifications	
Overall	213
Pipe Size and Material	217
Thickness Gauge	218
Transducer	217
Stopwatch Totalizer	60
System Description	2
T	
Task Keys	20
Test Keys	192
Test Points	59
Test Screen	191
Testing Timer Circuit	193
Theory of Operation	4

Thickness	
Calibrating	168
Displaying in Graphical Format	166, 167
Displaying in Numeric Format	165
Thickness Gauge	
Calibrating	168
Entering Programming Data	173
Low Signal Threshold	174
Setup	162
Sound Speed	171, 172
Specifications	218
Theory of Operation	249
Thickness Gauge Setup	175
Detection Threshold	175
Signal Inversion	175, 260
Transducer Delay	174
Time Delay, Entering	26
Time, Entering	115, 116
Timing Circuit	3
Totals, Resetting	126
Tracking Windows	37
Transducer	261
Connections	7
Delay	174
Entering Data for	23
Number, Entering	24
Option	23
Signal Limits	187
Spacing, Entering	40
Special	26
Specifications	217
Transducers	2
Axial Dimension	239
Bias 90° Installation	239
Installation Angle	239
Path Length	239
Problems	208
Wetted or Clamp-On	23
Transfer Log	143

Transit-Time, Theory of	4, 262
Transmit Signal Generator	3
Transmitter	3
Sample Size	182, 261
Traverses, Entering Number	40
Troubleshooting	201
Error Messages	202
Turning On/Off	15
Tw (time delay)	26

U

Units Option	113
USB Communications	
Changing Parameters	123
File Transfer	104
Using Drive Manager	102
User Functions Option	61
User Functions, Entering	61
User Table Option	127
User Tables, Creating	127

V

Velocity Averaging	183
Velocity Limits	188
View All Sites Option	148
View Menu in Log Manager	149
View Option	92

W

Warranty	275
Watchdog Test	193
Wave Sampling	195
Wave Snapshot Option	195
Wedge Angle, Entering	26
Wedge Sound Speed, Entering	29
Wedge Temperature, Entering	29
WEEE Directive	v
Wetted Transducers, Path Parameters for	41

Z

Zero (Base) Value for Analog Output	56
---	----

Zero Cutoff.....182

Warranty

Each instrument manufactured by GE Sensing is warranted to be free from defects in material and workmanship. Liability under this warranty is limited to restoring the instrument to normal operation or replacing the instrument, at the sole discretion of GE Sensing. Fuses and batteries are specifically excluded from any liability. This warranty is effective from the date of delivery to the original purchaser. If GE Sensing determines that the equipment was defective, the warranty period is:

- one year from delivery for electronic or mechanical failures
- one year from delivery for sensor shelf life

If GE Sensing determines that the equipment was damaged by misuse, improper installation, the use of unauthorized replacement parts, or operating conditions outside the guidelines specified by GE Sensing, the repairs are not covered under this warranty.

The warranties set forth herein are exclusive and are in lieu of all other warranties whether statutory, express or implied (including warranties or merchantability and fitness for a particular purpose, and warranties arising from course of dealing or usage or trade).

Return Policy

If a GE Sensing instrument malfunctions within the warranty period, the following procedure must be completed:

1. Notify GE Sensing, giving full details of the problem, and provide the model number and serial number of the instrument. If the nature of the problem indicates the need for factory service, GE Sensing will issue a RETURN AUTHORIZATION NUMBER (RAN), and shipping instructions for the return of the instrument to a service center will be provided.
2. If GE Sensing instructs you to send your instrument to a service center, it must be shipped prepaid to the authorized repair station indicated in the shipping instructions.
3. Upon receipt, GE Sensing will evaluate the instrument to determine the cause of the malfunction.

Then, one of the following courses of action will then be taken:

- If the damage is covered under the terms of the warranty, the instrument will be repaired at no cost to the owner and returned.
- If GE Sensing determines that the damage is not covered under the terms of the warranty, or if the warranty has expired, an estimate for the cost of the repairs at standard rates will be provided. Upon receipt of the owner's approval to proceed, the instrument will be repaired and returned.

We,

GE Sensing
1100 Technology Park Drive
Billerica, MA 01821
USA

declare under our sole responsibility that the

TransPort® PT878 Portable Ultrasonic Flowmeter
TransPort® PT878GC Clamp-On Portable Ultrasonic Flowmeter

to which this declaration relates, are in conformity with the following standard:

- EN 61326-1: 2006, Class A, Table A.1, Portable Equipment

following the provisions of the 2004/108/EC EMC Directive.

The units listed above and any ancillary equipment supplied with them do not bear CE marking for the Pressure Equipment Directive, as they are supplied in accordance with Article 3, Section 3 (sound engineering practices and codes of good workmanship) of the Pressure Equipment Directive 97/23/EC for DN<25.

Billerica - August 23, 2010
Issued



Mr. Gary Kozinski
Certification & Standards, Lead Engineer



Customer Support Centers

U.S.A.

The Boston Center
1100 Technology Park Drive
Billerica, MA 01821
U.S.A.
Tel: 800 833 9438 (toll-free)
978 437 1000
E-mail: sensing@ge.com

Ireland

Sensing House
Shannon Free Zone East
Shannon, County Clare
Ireland
Tel: +35 361 470200
E-mail: gesensingsnnservices@ge.com

An ISO 9001:2008 Certified Company

www.ge-mcs.com/en/about-us/quality.html

www.ge-mcs.com

©2015 General Electric Company. All rights reserved.
Technical content subject to change without notice.